



NCEES

This document may be printed from the NCEES Web site for your personal use, but it may not be copied, reproduced, distributed electronically or in print, or posted online without the express written permission of NCEES. Contact permissions@ncees.org for more information.



FE Reference Handbook 10.0.1

Copyright ©2020 by NCEES®. All rights reserved.

All NCEES material is copyrighted under the laws of the United States. No part of this publication may be reproduced, stored in a retrieval system, or transmitted in any form or by any means without the prior written permission of NCEES. Requests for permissions should be addressed in writing to permissions@ncees.org.

ISBN 978-1-947801-11-0

Printed in the United States of America
Second printing May 2020
Edition 10.0.1

Preface

About the *Handbook*

The Fundamentals of Engineering (FE) exam is computer-based, and the *FE Reference Handbook* is the only resource material you may use during the exam. Reviewing it before exam day will help you become familiar with the charts, formulas, tables, and other reference information provided. You won't be allowed to bring your personal copy of the *Handbook* into the exam room. Instead, the computer-based exam will include a PDF version of the *Handbook* for your use. No printed copies of the *Handbook* will be allowed in the exam room.

The PDF version of the *FE Reference Handbook* that you use on exam day will be very similar to the printed version. Pages not needed to solve exam questions—such as the cover, introductory material, index, and exam specifications—will not be included in the PDF version. In addition, NCEES will periodically revise and update the *Handbook*, and each FE exam will be administered using the updated version.

The *FE Reference Handbook* does not contain all the information required to answer every question on the exam. Basic theories, conversions, formulas, and definitions examinees are expected to know have not been included. Special material required for the solution of a particular exam question will be included in the question itself.

Updates on exam content and procedures

NCEES.org is our home on the web. Visit us there for updates on everything exam-related, including specifications, exam-day policies, scoring, and practice tests. A PDF version of the *FE Reference Handbook* similar to the one you will use on exam day is also available there.

Errata

To report errata in this book, send your correction using our chat feature or your account on NCEES.org. We will also post errata on the website. Examinees are not penalized for any errors in the *Handbook* that affect an exam question.



CONTENTS

Units and Conversion Factors	1
Ethics and Professional Practice	4
Safety	13
Mathematics	34
Engineering Probability and Statistics	63
Chemistry and Biology	85
Materials Science/Structure of Matter	94
Statics	107
Dynamics	114
Mechanics of Materials	130
Thermodynamics	143
Fluid Mechanics	177
Heat Transfer	204
Instrumentation, Measurement, and Control	220
Engineering Economics	230
Chemical Engineering	238
Civil Engineering	259
Environmental Engineering	310
Electrical and Computer Engineering	355
Industrial and Systems Engineering	417
Mechanical Engineering	431
Index	461
FE Exam Specifications	471

Units and Conversion Factors

Distinguishing pound-force from pound-mass

The FE exam and this handbook use both the metric system of units and the U.S. Customary System (USCS). In the USCS system of units, both force and mass are called pounds. Therefore, one must distinguish the pound-force (lbf) from the pound-mass (lbm).

The pound-force is that force which accelerates one pound-mass at 32.174 ft/sec². Thus, 1 lbf = 32.174 lbm-ft/sec². The expression 32.174 lbm-ft/(lbf-sec²) is designated as g_c and is used to resolve expressions involving both mass and force expressed as pounds. For instance, in writing Newton's second law, the equation would be written as $F = ma/g_c$, where F is in lbf, m in lbm, and a is in ft/sec².

Similar expressions exist for other quantities. Kinetic Energy, $KE = mv^2/2g_c$, with KE in (ft-lbf); Potential Energy, $PE = mgh/g_c$, with PE in (ft-lbf); Fluid Pressure, $p = \rho gh/g_c$, with p in (lbf/ft²); Specific Weight, $SW = \rho g/g_c$, in (lbf/ft³); Shear Stress, $\tau = (\mu/g_c)(dv/dy)$, with shear stress in (lbf/ft²). In all these examples, g_c should be regarded as a force unit conversion factor. It is frequently not written explicitly in engineering equations. However, its use is required to produce a consistent set of units.

Note that the force unit conversion factor g_c [lbm-ft/(lbf-sec²)] should not be confused with the local acceleration of gravity g, which has different units (m/s² or ft/sec²) and may be either its standard value (9.807 m/s² or 32.174 ft/sec²) or some other local value.

If the problem is presented in USCS units, it may be necessary to use the constant g_c in the equation to have a consistent set of units.

Constants and conversion factors provided are approximate, with sufficient accuracy to solve exam questions.

METRIC PREFIXES			COMMONLY USED EQUIVALENTS
Multiple	Prefix	Symbol	
10 ⁻¹⁸	atto	a	1 gallon of water weighs 8.34 lbf 1 cubic foot of water weighs 62.4 lbf 1 cubic inch of mercury weighs 0.491 lbf The mass of 1 cubic meter of water is 1,000 kilograms 1 mg/L is 8.34 × 10 ⁻⁶ lbf/gal
10 ⁻¹⁵	femto	f	
10 ⁻¹²	pico	p	
10 ⁻⁹	nano	n	
10 ⁻⁶	micro	μ	
10 ⁻³	milli	m	
10 ⁻²	centi	c	
10 ⁻¹	deci	d	
10 ¹	deka	da	
10 ²	hecto	h	
10 ³	kilo	k	
10 ⁶	mega	M	
10 ⁹	giga	G	
10 ¹²	tera	T	
10 ¹⁵	peta	P	
10 ¹⁸	exa	E	
			TEMPERATURE CONVERSIONS
			°F = 1.8 (°C) + 32
			°C = (°F - 32)/1.8
			°R = °F + 459.69
			K = °C + 273.15

Significant Figures

Significant figures of numbers in math operations will determine the accuracy of the result. General rules for significant digits are:

Rule 1: Non-zero digits are always significant.

Rule 2: Any zeros between two significant digits are significant.

Rule 3: All zeros in the decimal portion are significant.

Rule 4 (Addition and Subtraction): The number used in the calculation with the least number of significant digits after the decimal point dictates the number of significant figures after the decimal point. The number with the most significant figures to the left of the decimal point dictates the number of significant digits to the left of decimal point.

Rule 5 (Multiplication and Division): The result of the operation has the same number of significant digits as the input number with the least number of significant digits.

Rule 6: In the solution of engineering problems, it is customary to retain 3–4 significant digits in the final result.

Ideal Gas Constants

The universal gas constant, designated as \bar{R} in the table below, relates pressure, volume, temperature, and number of moles of an ideal gas. When that universal constant, \bar{R} , is divided by the molecular weight of the gas, the result, often designated as R , has units of energy per degree per unit mass [kJ/(kg·K) or ft-lbf/(lbm·°R)] and becomes characteristic of the particular gas. Some disciplines, notably chemical engineering, often use the symbol R to refer to the universal gas constant \bar{R} .

Fundamental Constants

Quantity		Symbol	Value	Units
electron charge		e	1.6022×10^{-19}	C (coulombs)
Faraday constant		F	96,485	coulombs/(mol)
gas constant	metric	\bar{R}	8,314	J/(kmol·K)
gas constant	metric	\bar{R}	8.314	kPa·m ³ /(kmol·K)
gas constant	USCS	\bar{R}	1,545	ft-lbf/(lb mole·°R)
		\bar{R}	0.08206	L·atm/(mole·K)
gravitation–Newtonian constant		G	6.673×10^{-11}	m ³ /(kg·s ²)
gravitation–Newtonian constant		G	6.673×10^{-11}	N·m ² /kg ²
gravity acceleration (standard)	metric	g	9.807	m/s ²
gravity acceleration (standard)	USCS	g	32.174	ft/sec ²
molar volume (ideal gas), $T = 273.15$ K, $p = 101.3$ kPa		V_m	22,414	L/kmol
speed of light (exact)		c	299,792,458	m/s
Stefan-Boltzmann constant		σ	5.67×10^{-8}	W/(m ² ·K ⁴)

Ethics and Professional Practice

Code of Ethics

Engineering is considered to be a "profession" rather than an "occupation" because of several important characteristics shared with other recognized learned professions, law, medicine, and theology: special knowledge, special privileges, and special responsibilities. Professions are based on a large knowledge base requiring extensive training. Professional skills are important to the well-being of society. Professions are self-regulating, in that they control the training and evaluation processes that admit new persons to the field. Professionals have autonomy in the workplace; they are expected to utilize their independent judgment in carrying out their professional responsibilities. Finally, professions are regulated by ethical standards. (Harris, C.E., M.S. Pritchard, & M.J. Rabins, *Engineering Ethics: Concepts and Cases*, Wadsworth Publishing company, pages 27–28, 1995.)

The expertise possessed by engineers is vitally important to societal welfare. In order to serve society effectively, engineers must maintain a high level of technical competence. However, a high level of technical expertise without adherence to ethical guidelines is as much a threat to public welfare as is professional incompetence. Therefore, engineers must also be guided by ethical principles.

The ethical principles governing the engineering profession are embodied in codes of ethics. Such codes have been adopted by state boards of registration, professional engineering societies, and even by some private industries. An example of one such code is the NCEES Rules of Professional Conduct, found in Section 240 of the *Model Rules* and presented here. As part of his/her responsibility to the public, an engineer is responsible for knowing and abiding by the code. Additional rules of conduct are also included in the *Model Rules*.

The three major sections of the *Model Rules* address (1) Licensee's Obligation to the Public, (2) Licensee's Obligation to Employers and Clients, and (3) Licensee's Obligation to Other Licensees. The principles amplified in these sections are important guides to appropriate behavior of professional engineers.

Application of the code in many situations is not controversial. However, there may be situations in which applying the code may raise more difficult issues. In particular, there may be circumstances in which terminology in the code is not clearly defined, or in which two sections of the code may be in conflict. For example, what constitutes "valuable consideration" or "adequate" knowledge may be interpreted differently by qualified professionals. These types of questions are called *conceptual issues*, in which definitions of terms may be in dispute. In other situations, *factual issues* may also affect ethical dilemmas. Many decisions regarding engineering design may be based upon interpretation of disputed or incomplete information. In addition, *tradeoffs* revolving around competing issues of risk vs. benefit, or safety vs. economics may require judgments that are not fully addressed simply by application of the code.

No code can give immediate and mechanical answers to all ethical and professional problems that an engineer may face. Creative problem solving is often called for in ethics, just as it is in other areas of engineering.

Model Rules, Section 240.15 Rules of Professional Conduct

To safeguard the health, safety, and welfare of the public and to maintain integrity and high standards of skill and practice in the engineering and surveying professions, the rules of professional conduct provided in this section shall be binding upon every licensee and on all firms authorized to offer or perform engineering or surveying services in this jurisdiction.

A. Licensee's Obligation to the Public

1. Licensees shall be cognizant that their first and foremost responsibility is to safeguard the health, safety, and welfare of the public when performing services for clients and employers.
2. Licensees shall sign and seal only those plans, surveys, and other documents that conform to accepted engineering and surveying standards and that safeguard the health, safety, and welfare of the public.
3. Licensees shall notify their employer or client and such other authority as may be appropriate when their professional judgment is overruled when the health, safety, or welfare of the public is endangered.
4. Licensees shall, to the best of their knowledge, include all relevant and pertinent information in an objective and truthful manner within all professional documents, statements, and testimony.
5. Licensees shall express a professional opinion publicly only when it is founded upon an adequate knowledge of the facts and a competent evaluation of the subject matter.

Ethics and Professional Practice

6. Licensees shall issue no statements, criticisms, or arguments on engineering and surveying matters that are inspired or paid for by interested parties, unless they explicitly identify the interested parties on whose behalf they are speaking and reveal any interest they have in the matters.
 7. Licensees shall not partner, practice, or offer to practice with any person or firm that they know is engaged in fraudulent or dishonest business or professional practices.
 8. Licensees who have knowledge or reason to believe that any person or firm has violated any rules or laws applying to the practice of engineering or surveying shall report it to the board, may report it to appropriate legal authorities, and shall cooperate with the board and those authorities as requested.
 9. Licensees shall not knowingly provide false or incomplete information regarding an applicant in obtaining licensure.
 10. Licensees shall comply with the licensing laws and rules governing their professional practice in each of the jurisdictions in which they practice.
- B. Licensee's Obligation to Employer and Clients
1. Licensees shall undertake assignments only when qualified by education or experience in the specific technical fields of engineering or surveying involved.
 2. Licensees shall not affix their signatures or seals to any plans or documents dealing with subject matter in which they lack competence, nor to any such plan or document not prepared under their responsible charge.
 3. Licensees may accept assignments and assume responsibility for coordination of an entire project if each technical segment is signed and sealed by the licensee responsible for preparation of that technical segment.
 4. Licensees shall not reveal facts, data, or information obtained in a professional capacity without the prior consent of the client, employer, or public body on which they serve except as authorized or required by law or rules.
 5. Licensees shall not solicit or accept gratuities, directly or indirectly, from contractors, their agents, or other parties in connection with work for employers or clients.
 6. Licensees shall disclose to their employers or clients all known or potential conflicts of interest or other circumstances that could influence or appear to influence their judgment or the quality of their professional service or engagement.
 7. Licensees shall not accept compensation, financial or otherwise, from more than one party for services pertaining to the same project, unless the circumstances are fully disclosed and agreed to in writing by all interested parties.
 8. Licensees shall not solicit or accept a professional contract from a governmental body on which a principal or officer of their organization serves as a member. Conversely, licensees serving as members, advisors, or employees of a government body or department, who are the principals or employees of a private concern, shall not participate in decisions with respect to professional services offered or provided by said concern to the governmental body that they serve.
 9. Licensees shall not use confidential information received in the course of their assignments as a means of making personal profit without the consent of the party from whom the information was obtained.
- C. Licensee's Obligation to Other Licensees
1. Licensees shall not falsify or permit misrepresentation of their, or their associates', academic or professional qualifications. They shall not misrepresent or exaggerate their degree of responsibility in prior assignments nor the complexity of said assignments. Presentations incidental to the solicitation of employment or business shall not misrepresent pertinent facts concerning employers, employees, associates, joint ventures, or past accomplishments.
 2. Licensees shall not offer, give, solicit, or receive, either directly or indirectly, any commission, or gift, or other valuable consideration in order to secure work, and shall not make any political contribution with the intent to influence the award of a contract by public authority.
 3. Licensees shall not injure or attempt to injure, maliciously or falsely, directly or indirectly, the professional reputation, prospects, practice, or employment of other licensees, nor indiscriminately criticize other licensees' work.
 4. Licensees shall make a reasonable effort to inform another licensee whose work is believed to contain a material discrepancy, error, or omission that may impact the health, safety, or welfare of the public, unless such reporting is legally prohibited.

Model Law, Section 110.20 Definitions

A. Engineer

1. Engineer—The term "Engineer," within the intent of this Act, shall mean an individual who is qualified to practice engineering by reason of engineering education, training, and experience in the application of engineering principles and the interpretation of engineering data.
2. Professional Engineer—The term "Professional Engineer," as used in this Act, shall mean an individual who has been duly licensed as a professional engineer by the board. The board may designate a professional engineer, on the basis of education, experience, and examination, as being licensed in a specific discipline or branch of engineering signifying the area in which the engineer has demonstrated competence.
3. Professional Engineer, Retired—The term "Professional Engineer, Retired," as used in this Act, shall mean an individual who has been duly licensed as a professional engineer by the board and who chooses to relinquish or not to renew a license and who applies to and is approved by the board to be granted the use of the title "Professional Engineer, Retired."
4. Engineer Intern—The term "Engineer Intern," as used in this Act, shall mean an individual who has been duly certified as an engineer intern by the board.
5. Practice of Engineering—The term "Practice of Engineering," as used in this Act, shall mean any service or creative work requiring engineering education, training, and experience in the application of engineering principles and the interpretation of engineering data to engineering activities that potentially impact the health, safety, and welfare of the public.

The services may include, but not be limited to, providing planning, studies, designs, design coordination, drawings, specifications, and other technical submissions; teaching engineering design courses; performing surveying that is incidental to the practice of engineering; and reviewing construction or other design products for the purposes of monitoring compliance with drawings and specifications related to engineered works.

Surveying incidental to the practice of engineering excludes the surveying of real property for the establishment of land boundaries, rights of way, easements, and the dependent or independent surveys or resurveys of the public land survey system.

An individual shall be construed to practice engineering, within the meaning and intent of this Act, if he or she does any of the following:

- a. Practices any discipline of the profession of engineering or holds himself or herself out as able and entitled to practice any discipline of engineering
 - b. Represents himself or herself to be a professional engineer by verbal claim, sign, advertisement, letterhead, or card or in any other way
 - c. Through the use of some other title, implies that he or she is a professional engineer under this Act
6. Inactive Status—Licensees who are not engaged in engineering practice that requires licensure in this jurisdiction may be granted inactive status. No licensee granted inactive status may practice or offer to practice engineering in this jurisdiction unless otherwise exempted in this Act.

- B. Professional Surveyor (Professional Land Surveyor, Professional Surveyor and Mapper, Geomatics Professional, or equivalent term); *See Model Law.*
- C. Board—The term "Board," as used in this Act, shall mean the jurisdiction board of licensure for professional engineers and professional surveyors, hereinafter provided by this Act.
- D. Jurisdiction—The term "Jurisdiction," as used in this Act, shall mean a state, the District of Columbia, or any territory, commonwealth, or possession of the United States that issues licenses to practice and regulates the practice of engineering and/or surveying within its legal boundaries.
- E. Responsible Charge—The term "Responsible Charge," as used in this Act, shall mean direct control and personal supervision of engineering or surveying work, as the case may be.
- F. Rules of Professional Conduct—The term "Rules of Professional Conduct," as used in this Act, shall mean those rules of professional conduct, if any, promulgated by the board as authorized by this Act.
- G. Firm—The term "Firm," as used in this Act, shall mean any form of business or entity other than an individual operating as a sole proprietorship under his or her own name.
- H. Managing Agent—The term "Managing Agent," as used in this Act, shall mean an individual who is licensed under this Act and who has been designated pursuant to Section 160.20 of this Act by the firm.
- I. Rules—The term "Rules," as used in this Act, shall mean those rules and regulations adopted pursuant to Section 120.60 A, Board Powers, of this Act.

- J. Signature—The term "Signature," as used in this Act, shall be in accordance with the Rules.
- K. Seal—The term "Seal," as used in this Act, shall mean a symbol, image, or list of information.
- L. Licensee—The term "Licensee," as used in this Act, shall mean a professional engineer or a professional surveyor.
- M. Person—The term "Person," as used in this Act, shall mean an individual or firm.
- N. Authoritative—The term "Authoritative," as used in this Act or Rules promulgated under this Act, shall mean being presented as trustworthy and competent when used to describe products, processes, applications, or data resulting from the practice of surveying.
- O. Disciplinary Action—The term "Disciplinary Action," as used in this Act, shall mean any final written decision or settlement taken against an individual or firm by a licensing board based upon a violation of the board's laws and rules.
- P. Positional accuracy—The extent to which horizontal and vertical information on a map or in a digital database matches true or accepted values that are relative to the earth's surface or other reference datum
- Q. Georeferenced—Being referenced, measured, or described in spatial terms relative to the earth's surface or other reference datum
- R. Surveying deliverables—Any map, database, report, or other similar electronic or printed deliverable that shows the authoritative location of features or coordinate systems. Surveying deliverables provide spatial information to a level of positional accuracy, whether that accuracy is stated, regulated, or implied.

Model Law, Section 130.10 General Requirements for Licensure

Education, experience, and examinations are required for licensure as a professional engineer or professional surveyor as set forth by the jurisdiction.

A. Eligibility for Licensure

To be eligible for licensure as a professional engineer or professional surveyor, an individual must meet all of the following requirements:

1. Be of good character and reputation
2. Satisfy the education criteria set forth by the board
3. Satisfy the experience criteria set forth by the board
4. Pass the applicable examinations set forth by the board
5. Submit five references acceptable to the board

B. Engineering

1. Certification or Enrollment as an Engineer Intern

The following shall be considered as minimum evidence that the applicant is qualified for certification as an engineer intern.

- a. Graduating from an engineering program of four years or more accredited by the Engineering Accreditation Commission of ABET (EAC/ABET), graduating from an engineering master's program accredited by EAC/ABET, or meeting the requirements of the NCEES *Engineering Education Standard*
- b. Passing the NCEES Fundamentals of Engineering (FE) examination

2. Licensure as a Professional Engineer

a. Initial Licensure as a Professional Engineer

An applicant who presents evidence of meeting the applicable education, examination, and experience requirements as described below shall be eligible for licensure as a professional engineer.

(1) Education Requirements

An individual seeking licensure as a professional engineer shall possess one or more of the following education qualifications:

- (a) A degree in engineering from an EAC/ABET-accredited bachelor's program
- (b) A degree in engineering from an EAC/ABET-accredited master's program
- (c) A bachelor's, master's, or doctoral degree in engineering from a non-EAC/ABET-accredited program.
This individual's education must be shown to meet the NCEES *Engineering Education Standard*.

(2) Examination Requirements

An individual seeking licensure as a professional engineer shall take and pass the NCEES Fundamentals of Engineering (FE) examination and the NCEES Principles and Practice of Engineering (PE) examination as described below.

- (a) The FE examination may be taken by a college senior or graduate of an engineering program of four years or more accredited by EAC/ABET, of a program that meets the requirements of the NCEES *Engineering Education Standard*, or of an engineering master's program accredited by EAC/ABET.

- (b) The PE examination may be taken by an engineer intern.
 - (3) Experience Requirements

An individual seeking licensure as a professional engineer shall present evidence of a specific record of four years of progressive engineering experience after a qualifying degree is conferred as described in a(1) above. This experience should be of a grade and character that indicate to the board that the applicant may be competent to practice engineering. The following educational criteria may apply as a substitute to the length of experience set forth above:

 - (a) An individual with a master's degree in engineering acceptable to the board: three years of experience after the qualifying bachelor's degree is conferred as described in a(1)(a) or a(1)(c) above
 - (b) An individual with an earned doctoral degree in engineering acceptable to the board and who has passed the FE exam: two years of experience
 - (c) An individual with an earned doctoral degree in engineering acceptable to the board and who has elected not to take the FE exam: four years of experience

A graduate degree that is used to satisfy education requirements cannot be applied for experience credit toward licensure. To be eligible for experience credit, graduate degrees shall be relevant to the applicant's area of professional practice.

Experience credit for a graduate degree cannot be earned concurrently with work experience credit.
 - b. Licensure by Comity for a Professional Engineer

The following shall be considered as minimum evidence satisfactory to the board that the applicant is qualified for licensure by comity as a professional engineer:

 - (1) An individual holding a certificate of licensure to engage in the practice of engineering issued by a proper authority of any jurisdiction or any foreign country, based on requirements that do not conflict with the provisions of this Act and possessing credentials that are, in the judgment of the board, of a standard that provides proof of minimal competency and is comparable to the applicable licensure act in effect in this jurisdiction at the time such certificate was issued may, upon application, be licensed without further examination except as required to examine the applicant's knowledge of statutes, rules, and other requirements unique to this jurisdiction; or
 - (2) An individual holding an active Council Record with NCEES, whose qualifications as evidenced by the Council Record meet the requirements of this Act, may, upon application, be licensed without further examination except as required to examine the applicant's knowledge of statutes, rules, and other requirements unique to this jurisdiction.
- C. Surveying; *See Model Law*

Model Law, Section 150.10, Grounds for Disciplinary Action—Licensees and Interns

- A. The board shall have the power to suspend, revoke, place on probation, fine, recover costs, and/or reprimand, or to refuse to issue, restore, or renew a license or intern certification to any licensee or intern that is found guilty of:
 - 1. Any fraud or deceit in obtaining or attempting to obtain or renew a certificate of licensure
 - 2. Any negligence, incompetence, or misconduct in the practice of engineering or surveying
 - 3. Conviction of or entry of a plea of guilty or nolo contendere to any crime that is a felony, whether or not related to the practice of engineering or surveying; and conviction of or entry of a plea of guilty or nolo contendere to any crime, whether a felony, misdemeanor, or otherwise, an essential element of which is dishonesty or which is directly related to the practice of engineering or surveying
 - 4. Failure to comply with any of the provisions of this Act or any of the rules or regulations of the board
 - 5. Discipline (including voluntary surrender of a professional engineer's or professional surveyor's license in order to avoid disciplinary action) by another jurisdiction, foreign country, or the United States government, if at least one of the grounds for discipline is the same or substantially equivalent to those contained in this Act
 - 6. Failure to provide information requested by the board as a result of a formal or informal complaint to the board that alleges a violation of this Act
 - 7. Knowingly making false statements or signing false statements, certifications, or affidavits in connection with the practice of engineering or surveying
 - 8. Aiding or assisting another person in violating any provision of this Act or the rules or regulations of the board
 - 9. Violating any terms of any Order imposed or agreed to by the board or using a seal or practicing engineering or surveying while the licensee's license is inactive or restricted

10. Signing, affixing, or permitting the licensee's seal or signature to be affixed to any specifications, reports, drawings, plans, plats, design information, construction documents or calculations, surveys, or revisions thereof which have not been prepared by the licensee or under the licensee's responsible charge
 11. Engaging in dishonorable, unethical, or unprofessional conduct of a character likely to deceive, defraud, or harm the public
 12. Providing false testimony or information to the board
 13. Habitual intoxication or addiction to the use of drugs or alcohol
 14. Providing engineering or surveying services outside any of the licensee's areas of competence
- B. In addition to or in lieu of any other sanction provided in this section, any licensee or intern that violates a provision of this Act or any rule or regulation of the board may be assessed a fine in an amount determined by the board of not more than *[insert amount]* dollars for each offense
1. Each day of continued violation may constitute a separate offense.
 2. In determining the amount of fine to be assessed pursuant to this section, the board may consider such factors as the following:
 - a. Whether the amount imposed will be a substantial economic deterrent to the violation
 - b. The circumstances leading to the violation
 - c. The severity of the violation and the risk of harm to the public
 - d. The economic benefits gained by the violator as a result of noncompliance
 - e. The interest of the public
 - f. Consistency of the fine with past fines for similar offenses, or justification for the fine amount

Model Law, Section 150.30 Grounds for Disciplinary Action—Unlicensed Individuals

- A. In addition to any other provisions of law, the board shall have the power to fine and recover costs from any unlicensed individual who is found guilty of:
1. Engaging in the practice or offer to practice of engineering or surveying in this jurisdiction without being licensed in accordance with the provisions of this Act
 2. Using or employing the words "engineer," "engineering," "surveyor," "surveying," or any modification or derivative thereof in his or her name or form of business activity except as licensed in this Act
 3. Presenting or attempting to use the certificate of licensure or seal of a licensee
 4. Engaging in any fraud or deceit in obtaining or attempting to obtain a certificate of licensure or intern certification
 5. Impersonating any licensee
 6. Using or attempting to use an expired, suspended, revoked, inactive, retired, or nonexistent certificate of licensure
- B. A fine assessed under this section may not exceed *[insert amount]* dollars for each offense.
- C. Each day of continued violation may constitute a separate offense.
- D. In determining the amount of fine to be assessed pursuant to this section, the board may consider such factors as the following:
1. Whether the amount imposed will be a substantial economic deterrent to the violation
 2. The circumstances leading to the violation
 3. The severity of the violation and the risk of harm to the public
 4. The economic benefits gained by the violator as a result of noncompliance
 5. The interest of the public
 6. Consistency of the fine with past fines for similar offenses, or justification for the fine amount

Model Law, Section 160.10 General Requirements for Certificates of Authorization

- A. A firm that practices or offers to practice engineering or surveying is required to obtain a certificate of authorization by the board in accordance with the Rules.
- B. This section shall not require a certificate of authorization for a firm performing engineering or surveying for the firm itself or for a parent or subsidiary of said firm.
- C. The secretary of state of this jurisdiction shall not accept organizational papers nor issue a certificate of incorporation, organization, licensure, or authorization to any firm which includes among the objectives for which it is established or within its name, any of the words "engineer," "engineering," "surveyor," "surveying," or any modification or derivation thereof unless the board has issued for said applicant a certificate of authorization or a letter indicating the eligibility of such applicant to receive such a certificate. The firm applying shall supply such certificate or letter from the board with its application for incorporation, organization, licensure, or authorization.

- D. The secretary of state of this jurisdiction shall decline to authorize any trade name, trademark, or service mark that includes therein such words as set forth in the previous subsection, or any modifications or derivatives thereof, except licensees and those firms holding certificates of authorization issued under the provisions of this section.

Model Law, Section 160.70 Grounds for Disciplinary Action—Firms Holding a Certificate of Authorization

- A. The board shall have the power to suspend, revoke, place on probation, fine, recover costs, and/or reprimand, or to refuse to issue, restore, or renew a certificate of authorization to any firm holding a certificate of authorization that is found guilty of:
1. Any fraud or deceit in obtaining or attempting to obtain or renew a certificate of authorization
 2. Any negligence, incompetence, or misconduct in the practice of engineering or surveying
 3. Conviction of or entry of a plea of guilty or nolo contendere to any crime that is a felony, whether or not related to the practice of engineering or surveying; and conviction of or entry of a plea of guilty or nolo contendere to any crime, whether a felony, misdemeanor, or otherwise, an essential element of which is dishonesty or which is directly related to the practice of engineering or surveying
 4. Failure to comply with any of the provisions of this Act or any of the rules or regulations of the board
 5. Discipline (including voluntary surrender of an engineering or surveying license in order to avoid disciplinary action) by another jurisdiction, foreign country, or the United States government, if at least one of the grounds for discipline is the same or substantially equivalent to those contained in this Act
 6. Failure to provide information requested by the board as a result of a formal or informal complaint to the board that alleges a violation of this Act
 7. Knowingly making false statements or signing false statements, certifications, or affidavits in connection with the practice of engineering or surveying
 8. Aiding or assisting another person in violating any provision of this Act or the rules or regulations of the board
 9. Violating any terms of any Order imposed or agreed to by the board or using a seal or practicing engineering or surveying while the firm's certificate of authorization is inactive or restricted
 10. Engaging in dishonorable, unethical, or unprofessional conduct of a character likely to deceive, defraud, or harm the public
 11. Providing false testimony or information to the board
- B. In addition to or in lieu of any other sanction provided in this section, any firm holding a certificate of authorization that violates a provision of this Act or any rule or regulation of the board may be assessed a fine in an amount determined by the board of not more than [insert amount] dollars for each offense.
1. Each day of continued violation may constitute a separate offense.
 2. In determining the amount of fine to be assessed pursuant to this section, the board may consider such factors as the following:
 - a. Whether the amount imposed will be a substantial economic deterrent to the violation
 - b. The circumstances leading to the violation
 - c. The severity of the violation and the risk of harm to the public
 - d. The economic benefits gained by the violator as a result of noncompliance
 - e. The interest of the public
 - f. Consistency of the fine with past fines for similar offenses, or justification for the fine amount
- C. In addition to any other sanction provided in this section, the board shall have the power to sanction as follows any firm where one or more of its managing agents, officers, directors, owners, or managers have been found guilty of any conduct which would constitute a violation under the provisions of this Act or any of the rules or regulations of the board:
1. Place on probation, fine, recover costs from, and/or reprimand
 2. Revoke, suspend, or refuse to issue, restore, or renew the certificate of authorization

Model Law, Section 170.30 Exemption Clause

This Act shall not be construed to prevent the following:

- A. Other Professions—The practice of any other legally recognized profession
- B. Contingent License—A contingent license may be issued by the board or board administrator to an applicant for licensure by comity if the applicant appears to meet the requirements for licensure by comity. Such a contingent license will be in effect from its date of issuance until such time as the board takes final action on the application for licensure by comity. If the board determines that the applicant does not meet the requirements for issuance of a license, the contingent license shall be immediately and automatically revoked upon notice to the applicant and no license will be issued.
- C. Employees and Subordinates—The work of an employee or a subordinate of an individual holding a certificate of licensure under this Act, or an employee of an individual practicing lawfully under Subsection B of this section, provided such work does not include final engineering or surveying designs or decisions and is done under the responsible charge of and verified by an individual holding a certificate of licensure under this Act or an individual practicing lawfully under Subsection B of this section.

Intellectual Property

Intellectual property is the creative product of the intellect and normally includes inventions, symbols, literary works, patents, and designs.

A number of options are available to individuals who wish to protect their intellectual property from being claimed or misused by others. There are four protection categories used to offer varying degrees of protection to intellectual property owners: Patents, Trademarks, Copyrights, and Trade Secrets.

Patents

A patent for an invention is the grant of a property right to the inventor, issued by the United States Patent and Trademark Office. Generally, the term of a new patent is 20 years from the date on which the application for the patent was filed in the United States or, in special cases, from the date an earlier related application was filed, subject to the payment of maintenance fees. U.S. patent grants are effective only within the United States, U.S. territories, and U.S. possessions.

There are three types of patents:

- 1 Utility patents may be granted to anyone who invents or discovers any new and useful process, machine, article of manufacture, or composition of matter, or any new and useful improvement thereof;
- 2 Design patents may be granted to anyone who invents a new, original, and ornamental design for an article of manufacture; and
- 3 Plant patents may be granted to anyone who invents or discovers and asexually reproduces any distinct and new variety of plant.

Trademarks

A trademark is a word, name, symbol, or device that is used in trade with goods to indicate the source of the goods and to distinguish them from the goods of others. Trademark rights may be used to prevent others from using a confusingly similar mark, but not to prevent others from making the same goods or from selling the same goods or services under a clearly different mark.

Copyrights

A copyright is a form of protection provided to the authors of "original works of authorship" including literary, dramatic, musical, artistic, and certain other intellectual works, both published and unpublished. The 1976 Copyright Act generally gives the owner of copyright the exclusive right to reproduce the copyrighted work, to prepare derivative works, to distribute copies or phonorecords of the copyrighted work, to perform the copyrighted work publicly, or to display the copyrighted work publicly.

Trade Secrets

A trade secret applies to a formula, pattern, compilation, program, device, method, technique, or process. To meet the most common definition of a trade secret, it must be used in business and give an opportunity to obtain an economic advantage over competitors who do not know or use it. Trade secrets offer little protection without a written agreement between the involved parties.

United States Patent and Trademark Office, <https://www.uspto.gov/patents-getting-started/general-information-concerning-patents#headings-2>.

Societal Considerations

"Creating a sustainable world that provides a safe, secure, healthy life for all peoples is a priority of the US engineering community. Engineers must deliver solutions that are technically viable, [economically] feasible, and environmentally and socially sustainable."

Reddy, K.R., C. Cameselle, and J.A.A. Adams, *Sustainable Engineering: Drivers, Metrics, Tools, and Applications*, 1st ed., John Wiley & Sons, 2019.

Sustainable approaches during planning, design, and construction or manufacture will carry forward throughout a project's or product's operation and maintenance to end-of-life. Sustainable principles include consideration of:

- Safety
- Public health
- Quality of life
- Resource allocation
- Non-renewable resources

Life-cycle analysis (cradle to grave) involves assessing the potential environmental consequences associated with a project or product from design and development through utilization and disposal. Engineers must employ concern for environmental health and public safety by addressing such things as:

- Landscape aesthetics
- Protection of ecosystems
- Resource conservation
- Air and water pollution
- Atmospheric emissions
- Collection and processing of waste

Adapted from: United States General Services Administration, "Sustainable Design" page, <https://www.gsa.gov/real-estate/design-construction/design-excellence/sustainability/sustainable-design>.

Dennis, "What is the Triple Bottom Line?" The Education Center (blog), RMA Environmental Services, <https://www.rmagreen.com/rma-blog/what-is-the-triple-bottom-line>.

Safety

Definition of Safety

Safety is the condition of protecting people from threats or failures that could harm their physical, emotional, occupational, psychological, or financial well-being. Safety is also the control of known threats to attain an acceptable level of risk.

The United States relies on public codes and standards, engineering designs, and corporate policies to ensure that a structure or place does what it should do to maintain a steady state of safety—that is, long-term stability and reliability. Some *Safety/Regulatory Agencies* that develop codes and standards commonly used in the United States are shown in the table.

Abbreviation	Name	Jurisdiction
ANSI	American National Standards Institute	Nonprofit standards organization
CGA	Compressed Gas Association	Nonprofit trade association
CSA	Canadian Standards Association	Nonprofit standards organization
FAA	Federal Aviation Administration	Federal regulatory agency
IEC	International Electrotechnical Commission	Nonprofit standards organization
ITSNA	Intertek Testing Services NA (formerly Edison Testing Labs)	Nationally recognized testing laboratory
MSHA	Mine Safety and Health Administration	Federal regulatory agency
NFPA	National Fire Protection Association	Nonprofit trade association
NIOSH	National Institute for Occupational Safety and Health	Federal regulatory agency
OSHA	Occupational Safety and Health Administration	Federal regulatory agency
RCRA	Resource Conservation and Recovery Act	Federal law
UL	Underwriters Laboratories	Nationally recognized testing laboratory
USCG	United States Coast Guard	Federal regulatory agency
USDOT	United States Department of Transportation	Federal regulatory agency
USEPA	United States Environmental Protection Agency	Federal regulatory agency

Safety and Prevention

A traditional preventive approach to both accidents and occupational illness involves recognizing, evaluating, and controlling hazards and work conditions that may cause physical or other injuries.

Hazard is the capacity to cause harm. It is an inherent quality of a material or a condition. For example, a rotating saw blade or an uncontrolled high-pressure jet of water has the capability (hazard) to slice through flesh. A toxic chemical or a pathogen has the capability (hazard) to cause illness.

Risk is the chance or probability that a person will experience harm and is not the same as a hazard. Risk always involves both probability and severity elements. The hazard associated with a rotating saw blade or the water jet continues to exist, but the probability of causing harm, and thus the risk, can be reduced by installing a guard or by controlling the jet's path. Risk is expressed by the equation:

$$\text{Risk} = \text{Hazard} \times \text{Probability}$$

When people discuss the hazards of disease-causing agents, the term *exposure* is typically used more than *probability*. If a certain type of chemical has a toxicity hazard, the risk of illness rises with the degree to which that chemical contacts your body or enters your lungs. In that case, the equation becomes:

$$\text{Risk} = \text{Hazard} \times \text{Exposure}$$

Organizations evaluate hazards using multiple techniques and data sources.

Job Safety Analysis

Job safety analysis (JSA) is known by many names, including activity hazard analysis (AHA), or job hazard analysis (JHA). Hazard analysis helps integrate accepted safety and health principles and practices into a specific task. In a JSA, each basic step of the job is reviewed, potential hazards identified, and recommendations documented as to the safest way to do the job. JSA techniques work well when used on a task that the analysts understand well. JSA analysts look for specific types of potential accidents and ask basic questions about each step, such as these:

- Can the employee strike against or otherwise make injurious contact with the object?
- Can the employee be caught in, on, or between objects?
- Can the employee strain muscles by pushing, pulling, or lifting?
- Is exposure to toxic gases, vapors, dust, heat, electrical currents, or radiation possible?

Hazard Assessments

Hazard Assessment

The fire/hazard diamond below summarizes common hazard data available on the Safety Data Sheet (SDS) and is frequently shown on chemical labels.

Position A – Health Hazard (Blue)

- 0 = normal material
- 1 = slightly hazardous
- 2 = hazardous
- 3 = extreme danger
- 4 = deadly

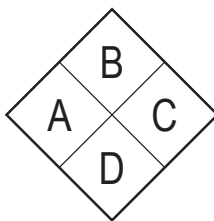

Position B – Flammability (Red)

- 0 = will not burn
- 1 = will ignite if preheated
- 2 = will ignite if moderately heated
- 3 = will ignite at most ambient temperature
- 4 = burns readily at ambient conditions

Position C – Reactivity (Yellow)

- 0 = stable and not reactive with water
- 1 = unstable if heated
- 2 = violent chemical change
- 3 = shock short may detonate
- 4 = may detonate

Position D – (White)

- ALKALI = alkali
- OXY = oxidizer
- ACID = acid
- Cor = corrosive
- W = use no water
-  = radiation hazard

GHS

The *Globally Harmonized System of Classification and Labeling of Chemicals*, or GHS, is a system for standardizing and harmonizing the classification and labeling of chemicals. GHS is a comprehensive approach to:

- Defining health, physical, and environmental hazards of chemicals
- Creating classification processes that use available data on chemicals for comparison with the defined hazard criteria
- Communicating hazard information, as well as protective measures, on labels and Safety Data Sheets (SDSs), formerly called Material Safety Data Sheets (MSDSs).

GHS label elements include:

- Precautionary statements and pictograms: Measures to minimize or prevent adverse effects
- Product identifier (ingredient disclosure): Name or number used for a hazardous product on a label or in the SDS
- Supplier identification: The name, address, and telephone number of the supplier
- Supplemental information: nonharmonized information

Other label elements include symbols, signal words, and hazard statements.

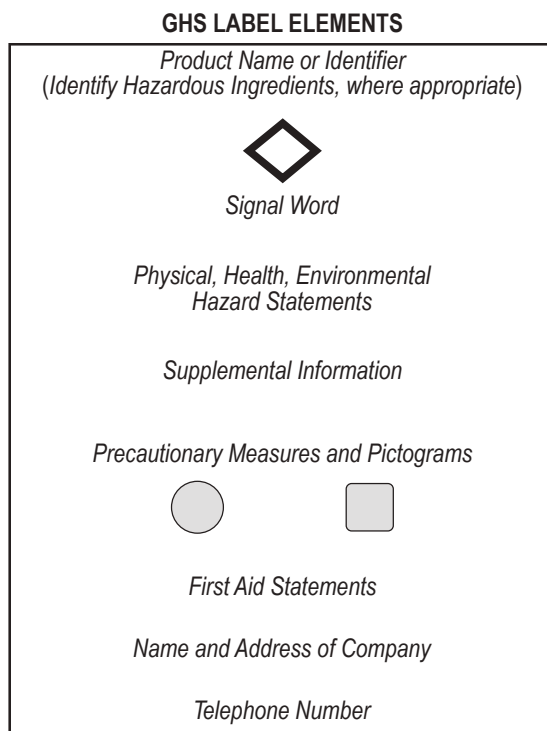

Safety

GHS PICTOGRAMS AND HAZARD CLASSES



- OXIDIZERS



- FLAMMABLES
- SELF-REACTIVES
- PYROPHORICS
- SELF-HEATING
- EMITS FLAMMABLE GAS
- ORGANIC PEROXIDES

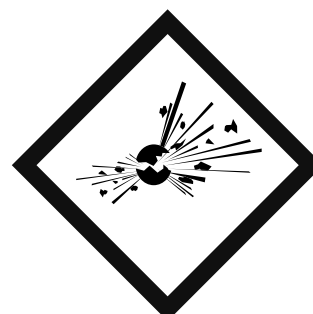

- EXPLOSIVES
- SELF-REACTIVES
- ORGANIC PEROXIDES



- ACUTE TOXICITY (SEVERE)



- CORROSIVES

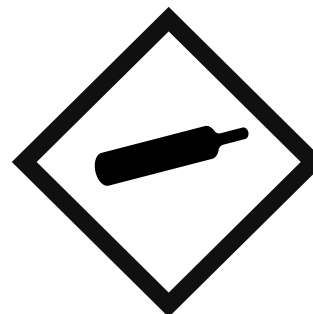

- GASES UNDER PRESSURE



- CARCINOGEN
- RESPIRATORY SENSITIZER
- REPRODUCTIVE TOXICITY
- TARGET ORGAN TOXICITY
- MUTAGENICITY
- ASPIRATION TOXICITY

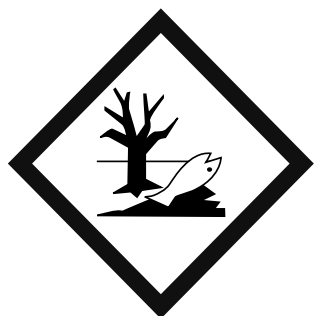

- ENVIRONMENTAL TOXICITY



- IRRITANT
- DERMAL SENSITIZER
- ACUTE TOXICITY (HARMFUL)
- NARCOTIC EFFECTS
- RESPIRATORY TRACT IRRITATION

Safety

TRANSPORT PICTOGRAMS



FLAMMABLE LIQUID
FLAMMABLE GAS
FLAMMABLE AEROSOL



FLAMMABLE SOLID
SELF-REACTIVE
SUBSTANCES

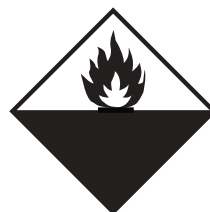

PYROPHORICS (SPONTANEOUSLY
COMBUSTIBLE)
SELF-HEATING SUBSTANCES



SUBSTANCES, WHICH IN
CONTACT WITH WATER,
EMIT FLAMMABLE GASES
(DANGEROUS WHEN WET)



OXIDIZING GASES
OXIDIZING LIQUIDS
OXIDIZING SOLIDS

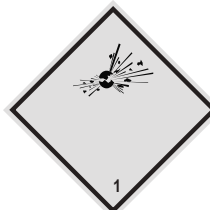

EXPLOSIVE DIVISIONS
1.1, 1.2, 1.3



EXPLOSIVE DIVISION 1.4



EXPLOSIVE DIVISION 1.5



EXPLOSIVE DIVISION 1.6

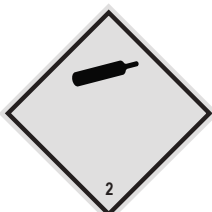

COMPRESSED GASES



ACUTE TOXICITY (POISON):
ORAL, DERMAL, INHALATION

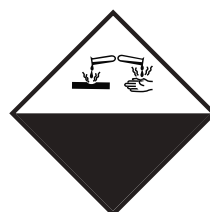

CORROSIVE







MARINE POLLUTANT



ORGANIC PEROXIDES

Safety

ACUTE ORAL TOXICITY					
LD ₅₀	CATEGORY 1 ≤ 5 mg/kg	CATEGORY 2 > 5 < 50 mg/kg	CATEGORY 3 ≥ 50 < 300 mg/kg	CATEGORY 4 ≥ 300 < 2,000 mg/kg	CATEGORY 5 ≥ 2,000 < 5,000 mg/kg
PICTOGRAM					NO SYMBOL
SIGNAL WORD	DANGER	DANGER	DANGER	WARNING	WARNING
HAZARD STATEMENT	FATAL IF SWALLOWED	FATAL IF SWALLOWED	TOXIC IF SWALLOWED	HARMFUL IF SWALLOWED	MAY BE HARMFUL IF SWALLOWED

Safety Data Sheet (SDS)

The SDS provides comprehensive information for use in workplace chemical management. Employers and workers use the SDS as a source of information about hazards and to obtain advice on safety precautions. The SDS is product related and, usually, is not able to provide information that is specific for any given workplace where the product may be used. However, the SDS information enables the employer to develop an active program of worker protection measures, including training, which is specific to the individual workplace, and to consider any measures that may be necessary to protect the environment. Information in an SDS also provides a source of information for those involved with the transport of dangerous goods, emergency responders, poison centers, those involved with the professional use of pesticides, and consumers.

The SDS has 16 sections in a set order, and minimum information is prescribed.

The Hazard Communication Standard (HCS) requires chemical manufacturers, distributors, or importers to provide SDSs to communicate the hazards of hazardous chemical products. As of June 1, 2015, the HCS requires new SDSs to be in a uniform format, and include the section numbers, the headings, and associated information under the headings below:

Section 1, Identification: Includes product identifier; manufacturer or distributor name, address, phone number; emergency phone number; recommended use; restrictions on use

Section 2, Hazard(s) identification: Includes all hazards regarding the chemical; required label elements

Section 3, Composition/information on ingredients: Includes information on chemical ingredients; trade secret claims

Section 4, First-aid measures: Includes important symptoms/effects, acute, and delayed; required treatment

Section 5, Fire-fighting measures: Lists suitable extinguishing techniques, equipment; chemical hazards from fire

Section 6, Accidental release measures: Lists emergency procedures; protective equipment; proper methods of containment and cleanup

Section 7, Handling and storage: Lists precautions for safe handling and storage, including incompatibilities

Section 8, Exposure controls/personal protection: Lists OSHA's Permissible Exposure Limits (PELs); Threshold Limit Values (TLVs); appropriate engineering controls; personal protective equipment (PPE)

Section 9, Physical and chemical properties: Lists the chemical's characteristics

Section 10, Stability and reactivity: Lists chemical stability and possibility of hazardous reactions

Section 11, Toxicological information: Includes routes of exposure; related symptoms, acute and chronic effects; numerical measures of toxicity

Section 12, Ecological information*

Section 13, Disposal considerations*

Section 14, Transport information*

Section 15, Regulatory information*

Section 16, Other information: Includes the date of preparation or last revision

*Note: Since other Agencies regulate this information, OSHA will not be enforcing Sections 12 through 15 (29 CFR 1910.1200(g)(2)).

Safety

Signal Words

The signal word found on every product's label is based on test results from various oral, dermal, and inhalation toxicity tests, as well as skin and eye corrosion assays in some cases. Signal words are placed on labels to convey a level of care that should be taken (especially personal protection) when handling and using a product, from purchase to disposal of the empty container, as demonstrated by the Pesticide Toxicity Table.

Pesticide Toxicity Categories

Signal Word on Label	Toxicity Category	Acute-Oral LD ₅₀ for Rats	Amount Needed to Kill an Average Size Adult	Notes
Danger–Poison	Highly Toxic	50 or less	Taste to a teaspoon	Skull and crossbones; Keep Out of Reach of Children
Warning	Moderately Toxic	50 to 500	One to six teaspoons	Keep Out of Reach of Children
Caution	Slightly Toxic	500 to 5,000	One ounce to a pint	Keep Out of Reach of Children
Caution	Relatively Nontoxic	>5,000	More than a pint	Keep Out of Reach of Children

LD₅₀ - See Risk Assessment/Toxicology section.

From Regulating Pesticides, U.S. Environmental Protection Agency.

Flammability

Flammable describes any solid, liquid, vapor, or gas that will ignite easily and burn rapidly. A flammable liquid is defined by NFPA and USDOT as a liquid with a flash point below 100°F (38°C). Flammability is further defined with lower and upper limits:

LFL = lower flammability limit (volume % in air)

UFL = upper flammability limit (volume % in air)

The LFL is also known as the lower explosive limit (LEL). The UFL is also referred to as the upper explosive limit (UEL). There is no difference between the terms *flammable* and *explosive* as applied to the lower and upper limits of flammability.

A vapor-air mixture will only ignite and burn over the range of concentrations between LFL and UFL. Examples are:

Gas/Compound	LFL	UFL
Acetone	2.6	13.0
Acetylene	2.5	100.0
Ammonia	15.0	28.0
<i>n</i> -butane	1.8	8.4
Carbon disulfide	1.3	50.0
Carbon monoxide	12.5	74.0
Cycloheptane	1.1	6.7
Cyclohexane	1.3	7.8
Cyclopropane	2.4	10.4
Diethyl ether	1.9	36.0
Ethane	3.0	12.4
Ethyl acetate	2.2	11.0
Ethyl alcohol	3.3	19.0
Ethyl ether	1.9	36.0
Ethyl nitrite	3.0	50.0
Ethylene	2.7	36.0
Gasoline 100/130	1.3	7.1
Gasoline 115/145	1.2	7.1
Hydrazine	4.7	100.0
Hydrogen	4.0	75.0
Hydrogen sulfide	4.0	44.0
Isobutane	1.8	8.4
Methane	5.0	15.0
Propane	2.1	9.5

From SFPE Handbook of Fire Protection Engineering, 4th ed., Society of Fire Protection Engineers, 2008.

LOC, limiting oxygen concentration (vol % O₂), is the concentration of oxygen below which combustion is not possible.

AIT, autoignition temperature, is the lowest temperature above which no external ignition source is required to initiate combustion.

Predicting Lower Flammable Limits of Mixtures of Flammable Gases (Le Chatelier's Rule)

Based on an empirical rule developed by Le Chatelier, the lower flammable limit of mixtures of multiple flammable gases in air can be determined. A generalization of Le Chatelier's rule is

$$\sum_{i=1}^n (C_i/LFL_i) \geq 1$$

where C_i is the volume percent of fuel gas, i , in the fuel/air mixture and LFL_i is the volume percent of fuel gas, i , at its lower flammable limit in air alone. If the indicated sum is greater than unity, the mixture is above the lower flammable limit. This can be restated in terms of the lower flammable limit concentration of the fuel mixture, LFL_m , as follows:

$$LFL_m = \frac{100}{\sum_{i=1}^n (C_{fi}/LFL_i)}$$

where C_{fi} is the volume percent of fuel gas i in the fuel gas mixture.

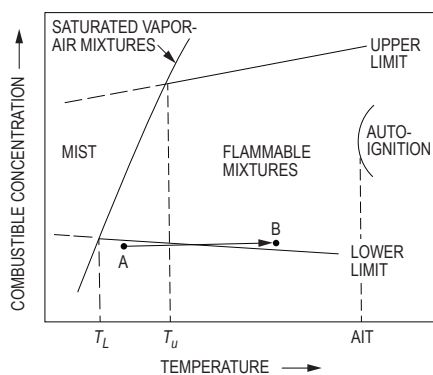

The SFPE Handbook of Fire Protection Engineering, 1st ed., Society of Fire Protection Association, 1988. With permission.

Granular Storage and Process Safety

Some materials that are not inherently hazardous can become hazardous during storage or processing. An example is the handling of grain in grain bins. Grain bins should not be entered when the grain is being removed since grains flow to the center of the emptying bin and create suffocation hazards. Bridging may occur at the top surface due to condensation and resulting spoilage creating a crust.

Organic vapors and dusts associated with grain handling often contain toxic yeasts or molds and have low oxygen contents. These organic vapors and dusts may also be explosive.

Confined Space Safety

Many workplaces contain spaces that are considered "confined" because their configurations hinder the activities of employees who must enter, work in, and exit them. A confined space has limited or restricted means for entry or exit and is not designed for continuous employee occupancy. Confined spaces include, but are not limited to, underground vaults, tanks, storage bins, manholes, pits, silos, process vessels, and pipelines. OSHA uses the term "permit-required confined spaces" (permit space) to describe a confined space that has one or more of the following characteristics: contains or has the potential to contain a hazardous atmosphere; contains a material that has the potential to engulf an entrant; has walls that converge inward or floors that slope downward and taper into a smaller area that could trap or asphyxiate an entrant; or contains any other recognized safety or health hazard such as unguarded machinery, exposed live wires or heat stress.

Sensor placement in confined spaces should be based on constituent gas molecular weight relative to that of air and, where applicable, source location.

OSHA has developed OSHA standards, directives (instructions for compliance officers), standard interpretations (official letters of interpretation of the standards), and national consensus standards related to confined spaces. The following gases are often present in confined spaces:

Safety

Ammonia: Irritating at 50 ppm and deadly above 1,000 ppm; sharp, cutting odor

Hydrogen sulfide: Irritating at 10 ppm and deadly at 500 ppm; accumulates at lower levels and in corners where circulation is minimal; rotten egg odor

Methane: Explosive at levels above 50,000 ppm, lighter than air, odorless

Carbon dioxide: Heavier than air, accumulates at lower levels and in corners where circulation is minimal, displaces air leading to asphyxiation

Electrical Safety

Current Level (Milliamperes)	Probable Effect on Human Body
1 mA	Perception level. Slight tingling sensation. Still dangerous under certain conditions.
5 mA	Slight shock felt; not painful but disturbing. Average individual can let go. However, strong involuntary reactions to shocks in this range may lead to injuries.
6 mA–16 mA	Painful shock, begin to lose muscular control. Commonly referred to as the freezing current or "let-go" range.
17 mA–99 mA	Extreme pain, respiratory arrest, severe muscular contractions. Individual cannot let go. Death is possible.
100 mA–2,000 mA	Ventricular fibrillation (uneven, uncoordinated pumping of the heart). Muscular contraction and nerve damage begins to occur. Death is likely.
> 2,000 mA	Cardiac arrest (stop in effective blood circulation), internal organ damage, and severe burns. Death is probable.

Worker Deaths by Electrocutation; A Summary of NIOSH Surveillance and Investigative Findings, U.S. Health and Human Services, (NIOSH), 1998.

Greenwald E.K., *Electrical Hazards and Accidents—Their Cause and Prevention*, Van Nostrand Reinhold, 1991.

Risk Assessment/Toxicology

Dose-Response Curves

The dose-response curve relates toxic response (i.e., percentage of test population exhibiting a specified symptom or dying) to the logarithm of the dosage [i.e., mg/(kg•day) ingested]. A typical dose-response curve is shown below.

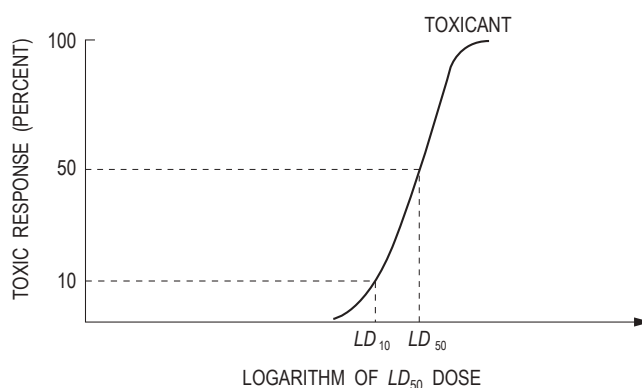

LC_{50}

Median lethal concentration in air that, based on laboratory tests, is expected to kill 50% of a group of test animals when administered as a single exposure over 1 or 4 hours.

LD_{50}

Median lethal single dose, based on laboratory tests, expected to kill 50% of a group of test animals, usually by oral or skin exposure.

Similar definitions exist for LC_{10} and LD_{10} , where the corresponding percentages are 10%.

Safety

Comparative Acutely Lethal Doses

Actual Ranking No.	LD ₅₀ (mg/kg)	Toxic Chemical
1	15,000	PCBs
2	10,000	Alcohol (ethanol)
3	4,000	Table salt—sodium chloride
4	1,500	Ferrous sulfate—an iron supplement
5	1,375	Malathion—pesticide
6	900	Morphine
7	150	Phenobarbital—a sedative
8	142	Tylenol (acetaminophen)
9	2	Strychnine—a rat poison
10	1	Nicotine
11	0.5	Curare—an arrow poison
12	0.001	2,3,7,8-TCDD (dioxin)
13	0.00001	Botulinum toxin (food poison)

Republished with permission of John Wiley and Sons, from *Principles of Toxicology: Environmental and Industrial Applications*, Williams, P.L., R.C. James, and S.M. Roberts, 2 ed, 2000; permission conveyed through Copyright Clearance Center, Inc.

Selected Chemical Interaction Effects

Effect	Relative toxicity (hypothetical)	Example
Additive	$2 + 3 = 5$	Organophosphate pesticides
Synergistic	$2 + 3 = 20$	Cigarette smoking + asbestos
Antagonistic	$6 + 6 = 8$	Toluene + benzene or caffeine + alcohol

Republished with permission of John Wiley and Sons, from *Principles of Toxicology: Environmental and Industrial Applications*, Williams, P.L., R.C. James, and S.M. Roberts, 2 ed, 2000; permission conveyed through Copyright Clearance Center, Inc.

Safety

Exposure Limits for Selected Compounds

N	Allowable Workplace Exposure Level (mg/m ³)	Chemical (use)
1	0.1	Iodine
2	5	Aspirin
3	10	Vegetable oil mists (cooking oil)
4	55	1,1,2-Trichloroethane (solvent/degreaser)
5	188	Perchloroethylene (dry-cleaning fluid)
6	170	Toluene (organic solvent)
7	269	Trichloroethylene (solvent/degreaser)
8	590	Tetrahydrofuran (organic solvent)
9	890	Gasoline (fuel)
10	1,590	Naphtha (rubber solvent)
11	1,910	1,1,1-Trichloroethane (solvent/degreaser)

Republished with permission of John Wiley and Sons, from *Principles of Toxicology: Environmental and Industrial Applications*, Williams, P.L., R.C. James, and S.M. Roberts, 2 ed, 2000; permission conveyed through Copyright Clearance Center, Inc.

Carcinogens

For carcinogens, EPA considers an acceptable risk to be within the range of 10^{-4} to 10^{-6} . The added risk of cancer is calculated as follows:

$$\text{Risk} = \text{dose} \times \text{toxicity} = CDI \times CSF$$

where

CDI = Chronic Daily Intake

CSF = Cancer Slope Factor. Slope of the dose-response curve for carcinogenic materials.

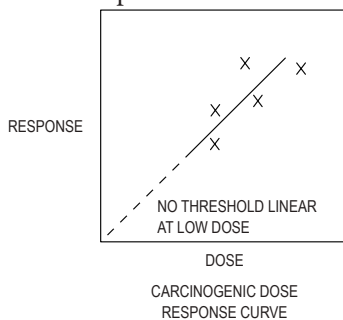

Threshold Limit Value (TLV)

TLV is the highest dose (ppm by volume in the atmosphere) the body is able to detoxify without any detectable effects.

Examples are:

<u>Compound</u>	<u>TLV</u>
Ammonia	25
Chlorine	0.5
Ethyl Chloride	1,000
Ethyl Ether	400

Noncarcinogens

For noncarcinogens, a hazard index (*HI*) is used to characterize risk from all pathways and exposure routes. EPA considers an *HI* > 1.0 as representing the possibility of an adverse effect occurring.

$$HI = CDI_{\text{noncarcinogen}} / RfD$$

$CDI_{\text{noncarcinogen}}$ = chronic daily intake of noncarcinogenic compound

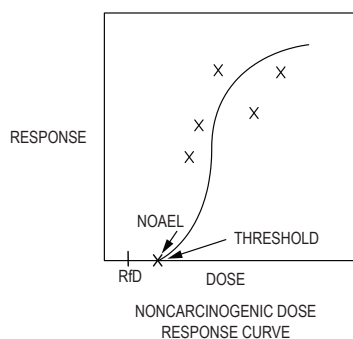

Dose is expressed

$$\left(\frac{\text{mass of chemical}}{\text{body weight} \cdot \text{exposure time}} \right)$$

NOAEL = No Observable Adverse Effect Level. The dose below which there are no harmful effects

Reference Dose

Reference dose (*RfD*) is determined from the Noncarcinogenic Dose-Response Curve using *NOAEL*.

RfD = lifetime (i.e., chronic) dose that a healthy person could be exposed to daily without adverse effects

$$RfD = \frac{NOAEL}{UF}$$

and

$$SHD = RfD \times W = \frac{NOAEL \times W}{UF}$$

where

SHD = safe human dose (mg/day)

NOAEL = threshold dose per kg of test animal [mg/(kg•day)] from the dose-response curve

UF = total uncertainty factor, depending on nature and reliability of the animal test data

W = weight of the adult male

Detailed Corrosion Data on Construction Materials

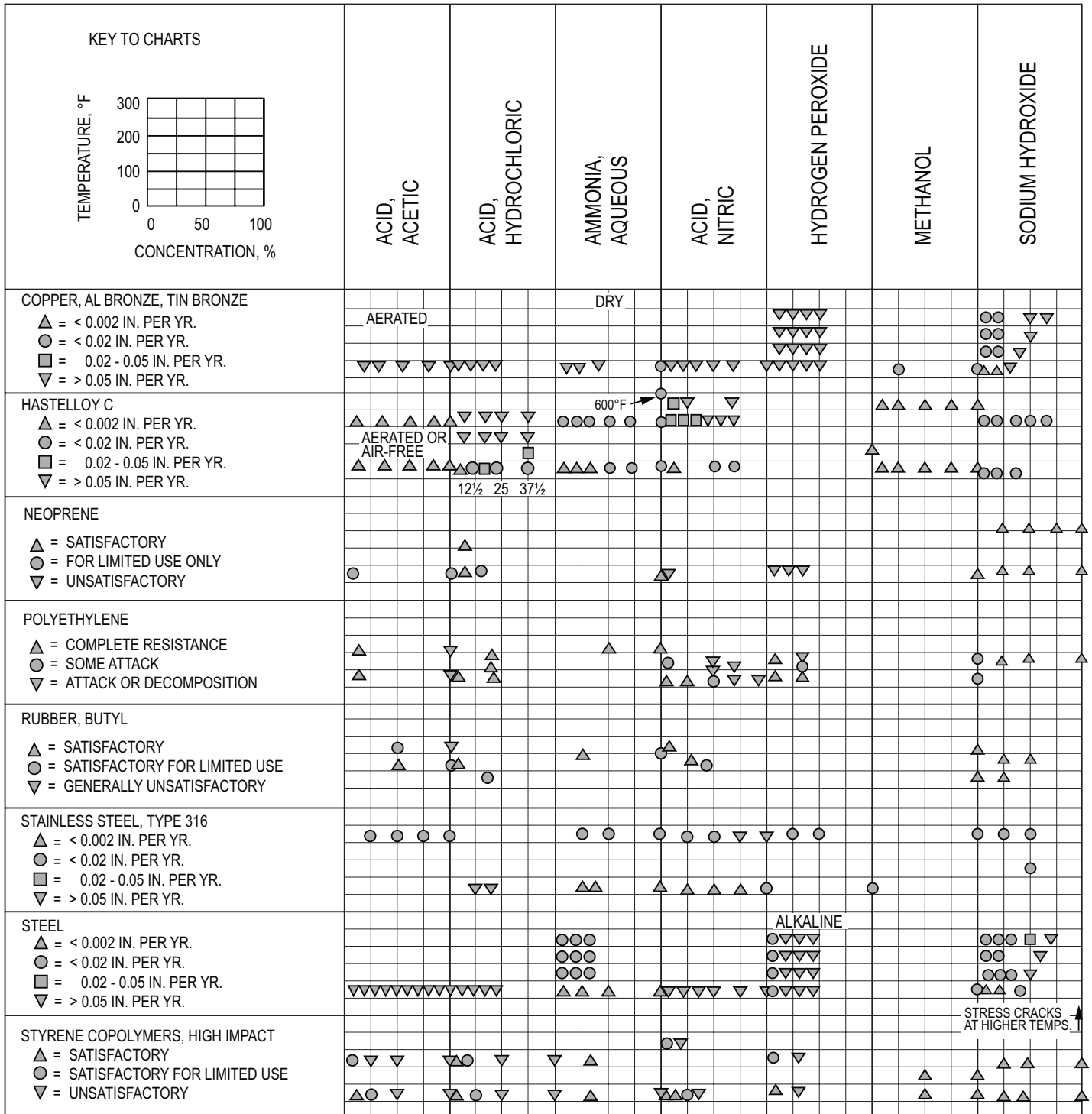

Adapted from Perry, Robert H., and Don Green, *Perry's Chemical Engineers' Handbook*, 6 ed, New York: McGraw-Hill, 1963, pp 23-13-23-30.

Exposure

Residential Exposure Equations for Various Pathways

Ingestion in drinking water

$$CDI = \frac{(CW)(IR)(EF)(ED)}{(BW)(AT)}$$

Ingestion while swimming

$$CDI = \frac{(CW)(CR)(ET)(EF)(ED)}{(BW)(AT)}$$

Dermal contact with water

$$AD = \frac{(CW)(SA)(PC)(ET)(EF)(ED)(CF)}{(BW)(AT)}$$

Ingestion of chemicals in soil

$$CDI = \frac{(CS)(IR)(CF)(FI)(EF)(ED)}{(BW)(AT)}$$

Dermal contact with soil

$$AD = \frac{(CS)(CF)(SA)(AF)(ABS)(EF)(ED)}{(BW)(AT)}$$

Inhalation of airborne (vapor phase) chemicals

$$CDI = \frac{(CA)(IR)(ET)(EF)(ED)}{(BW)(AT)}$$

Ingestion of contaminated fruits, vegetables, fish and shellfish

$$CDI = \frac{(CF)(IR)(FI)(EF)(ED)}{(BW)(AT)}$$

where

- ABS = absorption factor for soil contaminant (unitless)
- AD = absorbed dose (mg/[kg•day])
- AF = soil-to-skin adherence factor (mg/cm²)
- AT = averaging time (days)
- BW = body weight (kg)
- CA = contaminant concentration in air (mg/m³)
- CDI = chronic daily intake (mg/[kg•day])
- CF = volumetric conversion factor for water
= 1 L/1,000 cm³
= conversion factor for soil = 10⁻⁶ kg/mg
- CR = contact rate (L/hr)
- CS = chemical concentration in soil (mg/kg)
- CW = chemical concentration in water (mg/L)
- ED = exposure duration (years)
- EF = exposure frequency (days/yr or events/year)
- ET = exposure time (hr/day or hr/event)
- FI = fraction ingested (unitless)
- IR = ingestion rate (L/day or mg soil/day or kg/meal)
= inhalation rate (m³/hr)
- PC = chemical-specific dermal permeability constant (cm/hr)
- SA = skin surface area available for contact (cm²)

Intake Rates—Variable Values

EPA-Recommended Values for Estimating Intake

Parameter	Standard Value
Average body weight, female adult	65.4 kg
Average body weight, male adult	78 kg
Average body weight, child ^a	
6–11 months	9 kg
1–5 years	16 kg
6–12 years	33 kg
Amount of water ingested, adult	2.3 L/day
Amount of water ingested, child	1.5 L/day
Amount of air breathed, female adult	11.3 m ³ /day
Amount of air breathed, male adult	15.2 m ³ /day
Amount of air breathed, child (3–5 years)	8.3 m ³ /day
Amount of fish consumed, adult	6 g/day
Water swallowing rate, while swimming	50 mL/hr
Inhalation rates	
adult (6-hr day)	0.98 m ³ /hr
adult (2-hr day)	1.47 m ³ /hr
child	0.46 m ³ /hr
Skin surface available, adult male	1.94 m ²
Skin surface available, adult female	1.69 m ²
Skin surface available, child	
3–6 years (average for male and female)	0.720 m ²
6–9 years (average for male and female)	0.925 m ²
9–12 years (average for male and female)	1.16 m ²
12–15 years (average for male and female)	1.49 m ²
15–18 years (female)	1.60 m ²
15–18 years (male)	1.75 m ²
Soil ingestion rate, child 1–6 years	>100 mg/day
Soil ingestion rate, persons > 6 years	50 mg/day
Skin adherence factor, gardener's hands	0.07 mg/cm ²
Skin adherence factor, wet soil	0.2 mg/cm ²
Exposure duration	
Lifetime (carcinogens, for noncarcinogens use actual exposure duration)	75 years
At one residence, 90th percentile	30 years
National median	5 years
Averaging time	(ED)(365 days/year)
Exposure frequency (EF)	
Swimming	7 days/year
Eating fish and shellfish	48 days/year
Oral ingestion	350 days/year
Exposure time (ET)	
Shower, 90th percentile	12 min
Shower, 50th percentile	7 min

^aData in this category taken from: Copeland, T., A. M. Holbrow, J. M. Otan, et al., "Use of probabilistic methods to understand the conservatism in California's approach to assessing health risks posed by air contaminants," *Journal of the Air and Waste Management Association*, vol. 44, pp. 1399-1413, 1994.

Risk Assessment Guidance for Superfund. Volume 1, *Human Health Evaluation Manual* (part A). U.S. Environmental Protection Agency, EPA/540/1-89/002, 1989.

Concentrations of Vaporized Liquids

Vaporization Rate (Q_m , mass/time) from a Liquid Surface

$$Q_m = [MK_A_S P^{\text{sat}} / (R_g T_L)]$$

where

- M = molecular weight of volatile substance
- K = mass-transfer coefficient
- A_S = area of liquid surface
- P^{sat} = saturation vapor pressure of the pure liquid at T_L
- R_g = ideal gas constant
- T_L = absolute temperature of the liquid

Mass Flowrate of Liquid from a Hole in the Wall of a Process Unit

$$Q_m = A_H C_0 (2\rho g_c P_g)^{1/2}$$

where

- A_H = area of hole
- C_0 = discharge coefficient
- ρ = density of the liquid
- g_c = gravitational constant
- P_g = gauge pressure within the process unit

Concentration (C_{ppm}) of Vaporized Liquid in Ventilated Space

$$C_{\text{ppm}} = [Q_m R_g T \times 10^6 / (k Q_V P M)]$$

where

- T = absolute ambient temperature
- k = nonideal mixing factor
- Q_V = ventilation rate
- P = absolute ambient pressure

Sweep-Through Concentration Change in a Vessel

$$Q_V t = V \ln [(C_1 - C_0) / (C_2 - C_0)]$$

where

- Q_V = volumetric flowrate
- t = time
- V = vessel volume
- C_0 = inlet concentration
- C_1 = initial concentration
- C_2 = final concentration

Ergonomics

NIOSH Formula

Recommended Weight Limit (RWL)

$$RWL = 51(10/H)(1 - 0.0075|V - 30|)(0.82 + 1.8/D)(1 - 0.0032A)(FM)(CM)$$

where

RWL = recommended weight limit (pounds)

H = horizontal distance of the hand from the midpoint of the line joining the inner ankle bones to a point projected on the floor directly below the load center (inches)

V = vertical distance of the hands from the floor (inches)

D = vertical travel distance of the hands between the origin and destination of the lift (inches)

A = asymmetry angle (degrees)

FM = frequency multiplier (see table)

CM = coupling multiplier (see table)

Frequency Multiplier Table

F, min ⁻¹	≤ 8 hr/day		≤ 2 hr/day		≤ 1 hr/day	
	V < 30 in.	V ≥ 30 in.	V < 30 in.	V ≥ 30 in.	V < 30 in.	V ≥ 30 in.
0.2	0.85		0.95		1.00	
0.5	0.81		0.92		0.97	
1	0.75		0.88		0.94	
2	0.65		0.84		0.91	
3	0.55		0.79		0.88	
4	0.45		0.72		0.84	
5	0.35		0.60		0.80	
6	0.27		0.50		0.75	
7	0.22		0.42		0.70	
8	0.18		0.35		0.60	
9	0.15		0.30		0.52	
10	0.13		0.26		0.45	
11	0.00		0.23		0.41	
12			0.21		0.37	
13	0.00		0.00		0.34	
14					0.31	
15					0.28	

Waters, Thomas R., Ph.D., et al, *Applications Manual for the Revised NIOSH Lifting Equation*, Table 5, U.S. Department of Health and Human Services (NIOSH), January 1994.

**Coupling Multiplier (CM) Table
(Function of Coupling of Hands to Load)**

Container		Loose Part / Irreg. Object	
Optimal Design		Not	Comfort Grip
Opt. Handles or Cut-outs	Not	POOR	GOOD
GOOD	Flex Fingers	90 Degrees	Not
	FAIR		POOR

Coupling	V < 30 in. or 75 cm	V ≥ 30 in. or 75 cm
GOOD	1.00	
FAIR	0.95	
POOR	0.90	

Waters, Thomas R., Ph.D., et al, *Applications Manual for the Revised NIOSH Lifting Equation*, Table 7, U.S. Department of Health and Human Services (NIOSH), January 1994.

Biomechanics of the Human Body

Basic Equations

$$H_x + F_x = 0$$

$$H_y + F_y = 0$$

$$H_z + W + F_z = 0$$

$$T_{Hxz} + T_{Wxz} + T_{Fxz} = 0$$

$$T_{Hyz} + T_{Wyz} + T_{Fyz} = 0$$

$$T_{Hxy} + T_{Fxy} = 0$$

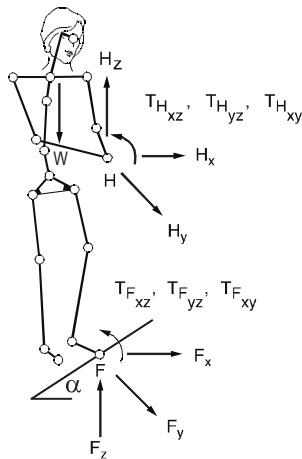

The coefficient of friction μ and the angle α at which the floor is inclined determine the equations at the foot.

$$F_x = \mu F_z$$

With the slope angle α

$$F_x = \mu F_z \cos \alpha$$

Of course, when motion must be considered, dynamic conditions come into play according to Newton's Second Law. Force transmitted with the hands is counteracted at the foot. Further, the body must also react with internal forces at all points between the hand and the foot.

Incidence Variable Values

Two concepts can be important when completing OSHA forms. These concepts are *incidence rates* and *severity rates*. On occasion it is necessary to calculate the total injury/illness incident rate of an organization in order to complete OSHA forms. This calculation must include fatalities and all injuries requiring medical treatment beyond mere first aid. The formula for determining the total injury/illness incident rate is as follows:

$$IR = N \times 200,000 \div T$$

where

IR = Total injury/illness incidence rate

N = Number of injuries, illnesses, and fatalities

T = Total hours worked by all employees during the period in question

The number 200,000 in the formula represents the number of hours 100 employees work in a year (40 hours per week \times 50 weeks = 2,000 hours per year per employee). Using the same basic formula with only minor substitutions, safety managers can calculate the following types of incidence rates:

1. Injury rate
2. Illness rate
3. Fatality rate
4. Lost workday cases rate
5. Number of lost workdays rate
6. Specific hazard rate
7. Lost workday injuries rate

Noise Pollution

$$\begin{aligned} \text{SPL (dB)} &= 10 \log_{10} \left(\frac{P^2}{P_0^2} \right) \\ \text{SPL}_{\text{total}} &= 10 \log_{10} \sum 10^{\text{SPL}/10} \end{aligned}$$

Point Source Attenuation

$$\Delta \text{ SPL (dB)} = 10 \log_{10} (r_1/r_2)^2$$

Line Source Attenuation

$$\Delta \text{ SPL (dB)} = 10 \log_{10} (r_1/r_2)$$

where

SPL (dB) = sound pressure level, measured in decibels

P = sound pressure (Pa)

P_0 = reference sound pressure (2×10^{-5} Pa)

$\text{SPL}_{\text{total}}$ = sum of multiple sources

$\Delta \text{ SPL (dB)}$ = change in sound pressure level with distance, measured in decibels

r_1 = distance from source to receptor at Point 1

r_2 = distance from source to receptor at Point 2

Permissible Noise Exposure (OSHA)

Noise dose D should not exceed 100%.

$$D = 100\% \times \sum \frac{C_i}{T_i}$$

where

C_i = time spent at specified sound pressure level, SPL (hours)

T_i = time permitted at SPL (hours)

$\sum C_i = 8$ (hours)

Noise Level (dBA)	Permissible Time (hr)
80	32
85	16
90	8
95	4
100	2
105	1
110	0.5
115	0.25
120	0.125
125	0.063
130	0.031

If $D > 100\%$, noise abatement required.

If $50\% \leq D \leq 100\%$, hearing conservation program required.

Note: $D = 100\%$ is equivalent to 90 dBA time-weighted average (TWA). $D = 50\%$ equivalent to TWA of 85 dBA.

Hearing conservation program requires: (1) testing employee hearing, (2) providing hearing protection at employee's request, and (3) monitoring noise exposure.

Exposure to impulsive or impact noise should not exceed 140 dB sound pressure level (SPL).

Mathematics

Discrete Math

Symbols

- $x \in X$ x is a member of X
- $\{ \}, \phi$ The empty (or null) set
- $S \subseteq T$ S is a subset of T
- $S \subset T$ S is a proper subset of T
- (a,b) Ordered pair
- $P(S)$ Power set of S
- (a_1, a_2, \dots, a_n) n -tuple
- $A \times B$ Cartesian product of A and B
- $A \cup B$ Union of A and B
- $A \cap B$ Intersection of A and B
- $\forall x$ Universal qualification for all x ; for any x ; for each x
- $\exists y$ Uniqueness qualification there exists y

A binary relation from A to B is a subset of $A \times B$.

Matrix of Relation

If $A = \{a_1, a_2, \dots, a_m\}$ and $B = \{b_1, b_2, \dots, b_n\}$ are finite sets containing m and n elements, respectively, then a relation R from A to B can be represented by the $m \times n$ matrix

$M_R = [m_{ij}]$, which is defined by:

$$m_{ij} = \begin{cases} 1 & \text{if } (a_i, b_j) \in R \\ 0 & \text{if } (a_i, b_j) \notin R \end{cases}$$

Directed Graphs, or Digraphs, of Relation

A directed graph, or digraph, consists of a set V of vertices (or nodes) together with a set E of ordered pairs of elements of V called edges (or arcs). For edge (a, b) , the vertex a is called the initial vertex and vertex b is called the terminal vertex. An edge of form (a, a) is called a loop.

Finite State Machine

A finite state machine consists of a finite set of states

$S_i = \{s_0, s_1, \dots, s_n\}$ and a finite set of inputs I ; and a transition function f that assigns to each state and input pair a new state.

A state (or truth) table can be used to represent the finite state machine.

State	Input			
	i_0	i_1	i_2	i_3
S_0	S_0	S_1	S_2	S_3
S_1	S_2	S_2	S_3	S_3
S_2	S_3	S_3	S_3	S_3
S_3	S_0	S_3	S_3	S_3

Another way to represent a finite state machine is to use a state diagram, which is a directed graph with labeled edges.

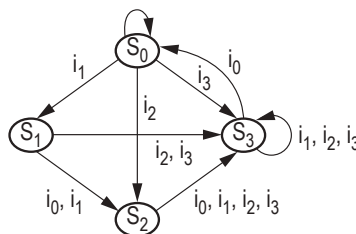

The characteristic of how a function maps one set (X) to another set (Y) may be described in terms of being either injective, surjective, or bijective.

An injective (one-to-one) relationship exists if, and only if,

$$\forall x_1, x_2 \in X, \text{ if } f(x_1) = f(x_2), \text{ then } x_1 = x_2$$

A surjective (onto) relationship exists when $\forall y \in Y, \exists x \in X$ such that $f(x) = y$

A bijective relationship is both injective (one-to-one) and surjective (onto).

Straight Line

The general form of the equation is

$$Ax + By + C = 0$$

The standard form of the equation is

$$y = mx + b,$$

which is also known as the *slope-intercept* form.

The *point-slope* form is

$$y - y_1 = m(x - x_1)$$

Given two points: slope,

$$m = (y_2 - y_1)/(x_2 - x_1)$$

The angle between lines with slopes m_1 and m_2 is

$$\alpha = \arctan [(m_2 - m_1)/(1 + m_2 \cdot m_1)]$$

Two lines are perpendicular if $m_1 = -1/m_2$

The distance between two points is

$$d = \sqrt{(y_2 - y_1)^2 + (x_2 - x_1)^2}$$

Quadratic Equation

$$ax^2 + bx + c = 0$$

$$x = \text{Roots} = \frac{-b \pm \sqrt{b^2 - 4ac}}{2a}$$

Quadric Surface (SPHERE)

The standard form of the equation is

$$(x - h)^2 + (y - k)^2 + (z - m)^2 = r^2$$

with center at (h, k, m) .

In a three-dimensional space, the distance between two points is

$$d = \sqrt{(x_2 - x_1)^2 + (y_2 - y_1)^2 + (z_2 - z_1)^2}$$

Logarithms

The logarithm of x to the Base b is defined by

$$\log_b(x) = c$$

where $b^c = x$

Special definitions for $b = e$ or $b = 10$ are:

$$\ln x, \text{ Base} = e$$

$$\log x, \text{ Base} = 10$$

To change from one Base to another:

$$\log_b x = (\log_a x)/(\log_a b)$$

e.g., $\ln x = (\log_{10} x)/(\log_{10} e) = 2.302585 (\log_{10} x)$

Identities

$$\begin{aligned} \log_b b^n &= n \\ \log x^c &= c \log x; x^c = \text{antilog}(c \log x) \\ \log xy &= \log x + \log y \\ \log_b b &= 1; \log 1 = 0 \\ \log x/y &= \log x - \log y \end{aligned}$$

Algebra of Complex Numbers

Complex numbers may be designated in rectangular form or polar form. In rectangular form, a complex number is written in terms of its real and imaginary components.

$$z = a + jb$$

where

$$\begin{aligned} a &= \text{real component} \\ b &= \text{imaginary component} \\ j &= \sqrt{-1} \text{ (some disciplines use } i = \sqrt{-1} \text{)} \end{aligned}$$

In polar form $z = c \angle \theta$

where

$$\begin{aligned} c &= \sqrt{a^2 + b^2}, \\ \theta &= \tan^{-1}(b/a), \\ a &= c \cos \theta, \text{ and} \\ b &= c \sin \theta. \end{aligned}$$

Complex numbers can be added and subtracted in rectangular form. If

$$\begin{aligned} z_1 &= a_1 + jb_1 = c_1 (\cos \theta_1 + j \sin \theta_1) = c_1 \angle \theta_1 \text{ and} \\ z_2 &= a_2 + jb_2 = c_2 (\cos \theta_2 + j \sin \theta_2) = c_2 \angle \theta_2, \text{ then} \\ z_1 + z_2 &= (a_1 + a_2) + j (b_1 + b_2) \text{ and} \\ z_1 - z_2 &= (a_1 - a_2) + j (b_1 - b_2) \end{aligned}$$

While complex numbers can be multiplied or divided in rectangular form, it is more convenient to perform these operations in polar form.

$$\begin{aligned} z_1 \times z_2 &= (c_1 \times c_2) \angle (\theta_1 + \theta_2) \\ z_1/z_2 &= (c_1/c_2) \angle (\theta_1 - \theta_2) \end{aligned}$$

The complex conjugate of a complex number $z_1 = (a_1 + jb_1)$ is defined as $z_1^* = (a_1 - jb_1)$. The product of a complex number and its complex conjugate is $z_1 z_1^* = a_1^2 + b_1^2$.

Polar Coordinate System

$$\begin{aligned} x &= r \cos \theta; y = r \sin \theta; \theta = \arctan(y/x) \\ r &= |x + jy| = \sqrt{x^2 + y^2} \\ x + jy &= r (\cos \theta + j \sin \theta) = r e^{j\theta} \end{aligned}$$

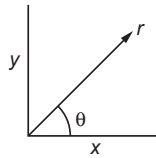

$$\begin{aligned} [r_1 (\cos \theta_1 + j \sin \theta_1)] [r_2 (\cos \theta_2 + j \sin \theta_2)] &= r_1 r_2 [\cos (\theta_1 + \theta_2) + j \sin (\theta_1 + \theta_2)] \\ (x + jy)^n &= [r (\cos \theta + j \sin \theta)]^n = r^n (\cos n\theta + j \sin n\theta) \\ \frac{r_1 (\cos \theta_1 + j \sin \theta_1)}{r_2 (\cos \theta_2 + j \sin \theta_2)} &= \frac{r_1}{r_2} [\cos (\theta_1 - \theta_2) + j \sin (\theta_1 - \theta_2)] \end{aligned}$$

Euler's Identity

$$e^{j\theta} = \cos \theta + j \sin \theta$$

$$e^{-j\theta} = \cos \theta - j \sin \theta$$

$$\cos \theta = \frac{e^{j\theta} + e^{-j\theta}}{2}, \quad \sin \theta = \frac{e^{j\theta} - e^{-j\theta}}{2j}$$

Roots

If k is any positive integer, any complex number (other than zero) has k distinct roots. The k roots of $r(\cos \theta + j \sin \theta)$ can be found by substituting successively $n = 0, 1, 2, \dots, (k - 1)$ in the formula

$$w = \sqrt[k]{r} \left[\cos \left(\frac{\theta}{k} + n \frac{360^\circ}{k} \right) + j \sin \left(\frac{\theta}{k} + n \frac{360^\circ}{k} \right) \right]$$

Trigonometry

Trigonometric functions are defined using a right triangle.

$$\sin \theta = y/r, \quad \cos \theta = x/r$$

$$\tan \theta = y/x, \quad \cot \theta = x/y$$

$$\csc \theta = r/y, \quad \sec \theta = r/x$$

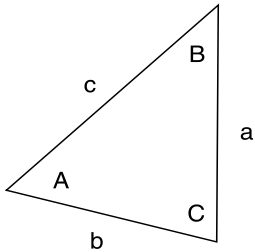
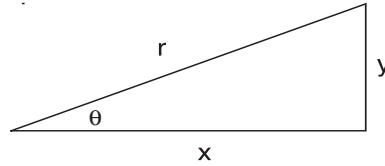

Law of Sines $\frac{a}{\sin A} = \frac{b}{\sin B} = \frac{c}{\sin C}$

Law of Cosines

$$a^2 = b^2 + c^2 - 2bc \cos A$$

$$b^2 = a^2 + c^2 - 2ac \cos B$$

$$c^2 = a^2 + b^2 - 2ab \cos C$$

Brink, R.W., *A First Year of College Mathematics*, D. Appleton-Century Co., Inc., Englewood Cliffs, NJ, 1937.

Identities

$$\cos \theta = \sin (\theta + \pi/2) = -\sin (\theta - \pi/2)$$

$$\sin \theta = \cos (\theta - \pi/2) = -\cos (\theta + \pi/2)$$

$$\csc \theta = 1/\sin \theta$$

$$\sec \theta = 1/\cos \theta$$

$$\tan \theta = \sin \theta/\cos \theta$$

$$\cot \theta = 1/\tan \theta$$

$$\sin^2 \theta + \cos^2 \theta = 1$$

$$\tan^2 \theta + 1 = \sec^2 \theta$$

$$\cot^2 \theta + 1 = \csc^2 \theta$$

$$\sin (\alpha + \beta) = \sin \alpha \cos \beta + \cos \alpha \sin \beta$$

$$\cos (\alpha + \beta) = \cos \alpha \cos \beta - \sin \alpha \sin \beta$$

$$\sin 2\alpha = 2 \sin \alpha \cos \alpha$$

$$\cos 2\alpha = \cos^2 \alpha - \sin^2 \alpha = 1 - 2 \sin^2 \alpha = 2 \cos^2 \alpha - 1$$

$$\tan 2\alpha = (2 \tan \alpha)/(1 - \tan^2 \alpha)$$

$$\cot 2\alpha = (\cot^2 \alpha - 1)/(2 \cot \alpha)$$

$$\tan (\alpha + \beta) = (\tan \alpha + \tan \beta)/(1 - \tan \alpha \tan \beta)$$

$$\cot (\alpha + \beta) = (\cot \alpha \cot \beta - 1)/(\cot \alpha + \cot \beta)$$

$$\sin (\alpha - \beta) = \sin \alpha \cos \beta - \cos \alpha \sin \beta$$

$$\cos (\alpha - \beta) = \cos \alpha \cos \beta + \sin \alpha \sin \beta$$

$$\tan (\alpha - \beta) = (\tan \alpha - \tan \beta)/(1 + \tan \alpha \tan \beta)$$

$$\cot (\alpha - \beta) = (\cot \alpha \cot \beta + 1)/(\cot \beta - \cot \alpha)$$

$$\sin (\alpha/2) = \pm\sqrt{(1 - \cos \alpha)/2}$$

$$\cos (\alpha/2) = \pm\sqrt{(1 + \cos \alpha)/2}$$

$$\tan (\alpha/2) = \pm\sqrt{(1 - \cos \alpha)/(1 + \cos \alpha)}$$

$$\cot (\alpha/2) = \pm\sqrt{(1 + \cos \alpha)/(1 - \cos \alpha)}$$

$$\sin \alpha \sin \beta = (1/2)[\cos (\alpha - \beta) - \cos (\alpha + \beta)]$$

$$\cos \alpha \cos \beta = (1/2)[\cos (\alpha - \beta) + \cos (\alpha + \beta)]$$

$$\sin \alpha \cos \beta = (1/2)[\sin (\alpha + \beta) + \sin (\alpha - \beta)]$$

$$\sin \alpha + \sin \beta = 2 \sin [(1/2)(\alpha + \beta)] \cos [(1/2)(\alpha - \beta)]$$

$$\sin \alpha - \sin \beta = 2 \cos [(1/2)(\alpha + \beta)] \sin [(1/2)(\alpha - \beta)]$$

$$\cos \alpha + \cos \beta = 2 \cos [(1/2)(\alpha + \beta)] \cos [(1/2)(\alpha - \beta)]$$

$$\cos \alpha - \cos \beta = -2 \sin [(1/2)(\alpha + \beta)] \sin [(1/2)(\alpha - \beta)]$$

Mensuration of Areas and Volumes

Nomenclature

A = total surface area

P = perimeter

V = volume

Parabola

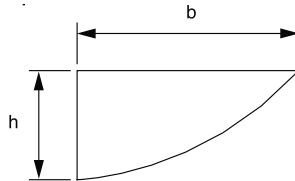

$$A = 2bh/3$$

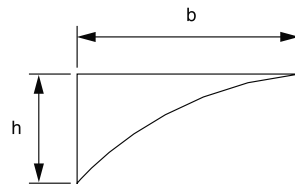

$$A = bh/3$$

Ellipse

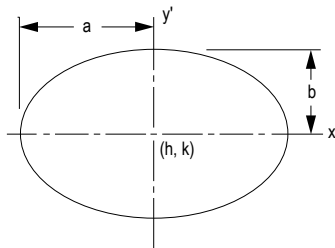

$$P_{approx} = 2\pi\sqrt{(a^2 + b^2)/2}$$

$$P = \pi(a + b) \left[1 + \left(\frac{1}{2}\right)^2 \lambda^2 + \left(\frac{1}{2} \times \frac{1}{4}\right)^2 \lambda^4 + \left(\frac{1}{2} \times \frac{1}{4} \times \frac{3}{6}\right)^2 \lambda^6 + \left(\frac{1}{2} \times \frac{1}{4} \times \frac{3}{6} \times \frac{5}{8}\right)^2 \lambda^8 + \left(\frac{1}{2} \times \frac{1}{4} \times \frac{3}{6} \times \frac{5}{8} \times \frac{7}{10}\right)^2 \lambda^{10} + \dots \right]$$

where

$$\lambda = (a - b)/(a + b)$$

Gieck, K., and R. Gieck, *Engineering Formulas*, 6th ed., Gieck Publishing, 1967.

Circular Segment

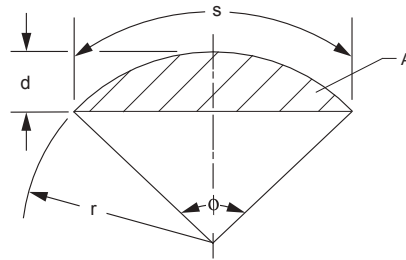

$$A = \left[r^2 (\phi - \sin \phi) \right] / 2$$

$$\phi = s/r = 2 \left\{ \arccos \left[(r-d)/r \right] \right\}$$

Gieck, K., and R. Gieck, *Engineering Formulas*, 6th ed., Gieck Publishing, 1967.

Circular Sector

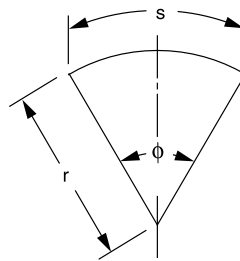

$$A = \phi r^2 / 2 = sr / 2$$

$$\phi = s/r$$

Gieck, K., and R. Gieck, *Engineering Formulas*, 6th ed., Gieck Publishing, 1967.

Sphere

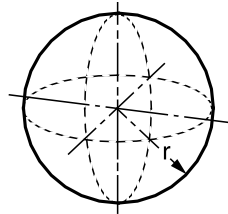

$$V = 4\pi r^3 / 3 = \pi d^3 / 6$$

$$A = 4\pi r^2 = \pi d^2$$

Gieck, K., and R. Gieck, *Engineering Formulas*, 6th ed., Gieck Publishing, 1967.

Parallelogram

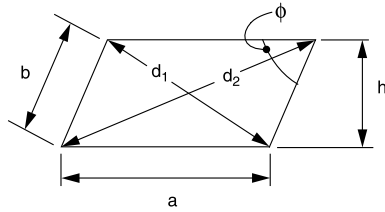

$$P = 2(a + b)$$

$$d_1 = \sqrt{a^2 + b^2 - 2ab(\cos \phi)}$$

$$d_2 = \sqrt{a^2 + b^2 + 2ab(\cos \phi)}$$

$$d_1^2 + d_2^2 = 2(a^2 + b^2)$$

$$A = ah = ab(\sin \phi)$$

If $a = b$, the parallelogram is a rhombus.

Regular Polygon (n equal sides)

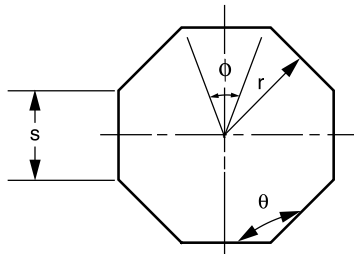

$$\phi = 2\pi/n$$

$$\theta = \left[\frac{\pi(n-2)}{n} \right] = \pi \left(1 - \frac{2}{n} \right)$$

$$P = ns$$

$$s = 2r \left[\tan(\phi/2) \right]$$

$$A = (nsr)/2$$

Gieck, K., and R. Gieck, *Engineering Formulas*, 6th ed., Gieck Publishing, 1967.

Prismoid

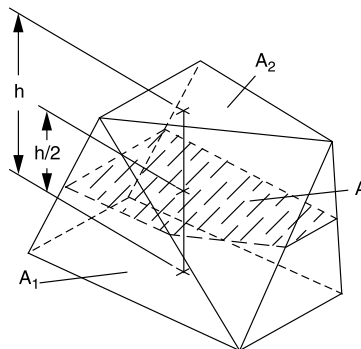

$$V = (h/6)(A_1 + A_2 + 4A)$$

Gieck, K., and R. Gieck, *Engineering Formulas*, 6th ed., Gieck Publishing, 1967.

Right Circular Cone

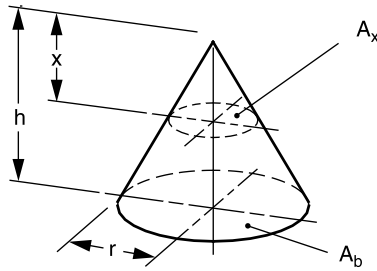

$$V = (\pi r^2 h) / 3$$

$$A = \text{side area} + \text{base area} = \pi r (r + \sqrt{r^2 + h^2})$$

$$A_x : A_b = x^2 : h^2$$

Gieck, K., and R. Gieck, *Engineering Formulas*, 6th ed., Gieck Publishing, 1967.

Right Circular Cylinder

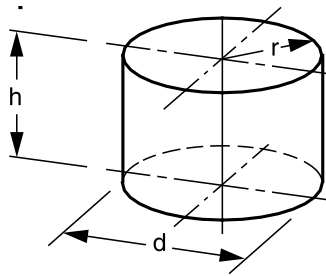

$$V = \pi r^2 h = \frac{\pi d^2 h}{4}$$

$$A = \text{side area} + \text{end areas} = 2\pi r (h + r)$$

Gieck, K., and R. Gieck, *Engineering Formulas*, 6th ed., Gieck Publishing, 1967.

Paraboloid of Revolution

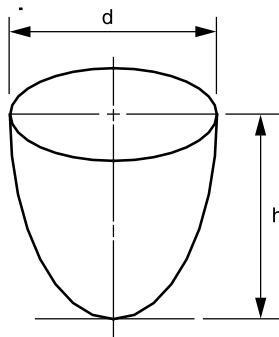

$$V = \frac{\pi d^2 h}{8}$$

Gieck, K., and R. Gieck, *Engineering Formulas*, 6th ed., Gieck Publishing, 1967.

Conic Sections

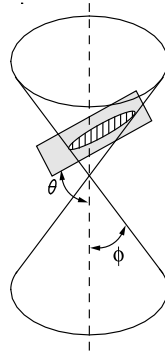

$$e = \text{eccentricity} = \cos \theta / (\cos \phi)$$

[Note: X' and Y' , in the following cases, are translated axes.]

Gieck, K., and R. Gieck, *Engineering Formulas*, 6th ed., Gieck Publishing, 1967.

Case 1. Parabola $e = 1$:

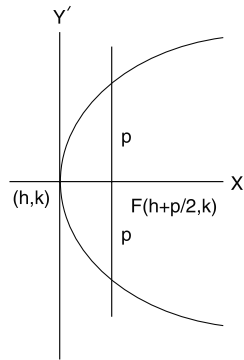

$(y - k)^2 = 2p(x - h)$; Center at (h, k) is the standard form of the equation. When $h = k = 0$, Focus: $(p/2, 0)$; Directrix: $x = -p/2$

Brink, R.W., *A First Year of College Mathematics*, D. Appleton-Century Company, Inc. (Prentice Hall), 1937.

Case 2. Ellipse $e < 1$:

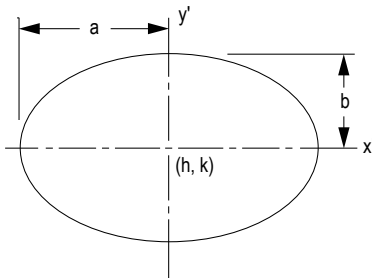

$\frac{(x - h)^2}{a^2} + \frac{(y - k)^2}{b^2} = 1$; Center at (h, k) is the standard form of the equation. When $h = k = 0$,

Eccentricity: $e = \sqrt{1 - (b^2/a^2)} = c/a$

$$b = a\sqrt{1 - e^2};$$

Focus: $(\pm ae, 0)$; Directrix: $x = \pm a/e$

Brink, R.W., *A First Year of College Mathematics*, D. Appleton-Century Company, Inc. (Prentice Hall), 1937.

Case 3. Hyperbola $e > 1$:

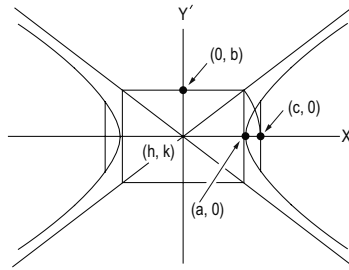

$$\frac{(x - h)^2}{a^2} - \frac{(y - k)^2}{b^2} = 1;$$

Center at (h, k) is the standard form of the equation. When $h = k = 0$,

Eccentricity: $e = \sqrt{1 + (b^2/a^2)} = c/a$

$$b = a\sqrt{e^2 - 1};$$

Focus: $(\pm ae, 0)$; Directrix: $x = \pm a/e$

Brink, R.W., *A First Year of College Mathematics*, D. Appleton-Century Company, Inc. (Prentice Hall), 1937.

Case 4. Circle $e = 0$:

$(x - h)^2 + (y - k)^2 = r^2$; Center at (h, k) is the standard form of the equation with radius

$$r = \sqrt{(x - h)^2 + (y - k)^2}$$

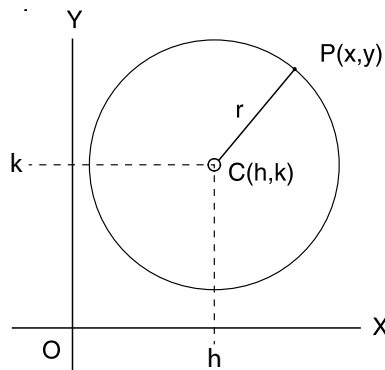

Length of the tangent line from a point on a circle to a point (x', y') :

$$t^2 = (x' - h)^2 + (y' - k)^2 - r^2$$

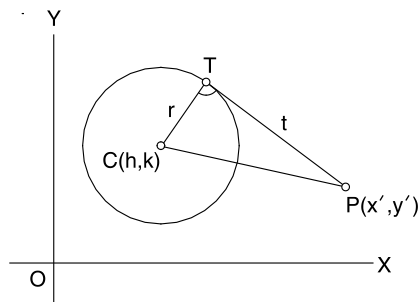

Brink, R.W., *A First Year of College Mathematics*, D. Appleton-Century Company, Inc. (Prentice Hall), 1937.

Conic Section Equation

The general form of the conic section equation is

$$Ax^2 + Bxy + Cy^2 + Dx + Ey + F = 0$$

where not both A and C are zero.

If $B^2 - 4AC < 0$, an ellipse is defined.

If $B^2 - 4AC > 0$, a hyperbola is defined.

If $B^2 - 4AC = 0$, the conic is a parabola.

If $A = C$ and $B = 0$, a circle is defined.

If $A = B = C = 0$, a straight line is defined.

$$x^2 + y^2 + 2ax + 2by + c = 0$$

is the normal form of the conic section equation, if that conic section has a principal axis parallel to a coordinate axis.

$$h = -a; k = -b$$

$$r = \sqrt{a^2 + b^2 - c}$$

If $a^2 + b^2 - c$ is positive, a circle, center $(-a, -b)$.

If $a^2 + b^2 - c$ equals zero, a point at $(-a, -b)$.

If $a^2 + b^2 - c$ is negative, locus is imaginary.

Differential Calculus

The Derivative

For any function $y = f(x)$, the derivative = $D_x y = dy/dx = y'$

$$y' = \lim_{\Delta x \rightarrow 0} [(\Delta y)/(\Delta x)]$$

$$= \lim_{\Delta x \rightarrow 0} \{ [f(x + \Delta x) - f(x)]/(\Delta x) \}$$

y' = the slope of the curve $f(x)$.

Test for a Maximum

$y = f(x)$ is a maximum for

$x = a$, if $f'(a) = 0$ and $f''(a) < 0$.

Test for a Minimum

$y = f(x)$ is a minimum for

$x = a$, if $f'(a) = 0$ and $f''(a) > 0$.

Test for a Point of Inflection

$y = f(x)$ has a point of inflection at $x = a$,

if $f''(a) = 0$, and

if $f''(x)$ changes sign as x increases through

$x = a$.

The Partial Derivative

In a function of two independent variables x and y , a derivative with respect to one of the variables may be found if the other variable is *assumed* to remain constant. If y is *kept fixed*, the function

$$z = f(x, y)$$

becomes a function of the *single variable* x , and its derivative (if it exists) can be found. This derivative is called the *partial derivative of z with respect to x* . The partial derivative with respect to x is denoted as follows:

$$\frac{\partial z}{\partial x} = \frac{\partial f(x, y)}{\partial x}$$

The Curvature of Any Curve

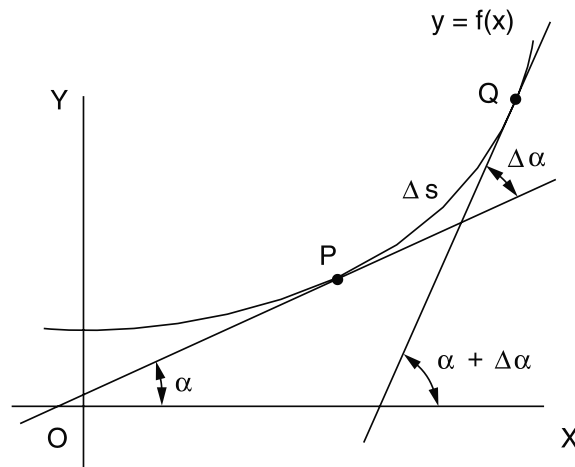

The curvature K of a curve at P is the limit of its average curvature for the arc PQ as Q approaches P . This is also expressed as: the curvature of a curve at a given point is the rate-of-change of its inclination with respect to its arc length.

$$K = \lim_{\Delta s \rightarrow 0} \frac{\Delta \alpha}{\Delta s} = \frac{d\alpha}{ds}$$

Wade, Thomas L., *Calculus*, Boston, Ginn and Company, 1953.

Curvature in Rectangular Coordinates

$$K = \frac{y''}{[1 + (y')^2]^{3/2}}$$

When it may be easier to differentiate the function with respect to y rather than x , the notation x' will be used for the derivative.

$$x' = dx/dy$$

$$K = \frac{-x''}{[1 + (x')^2]^{3/2}}$$

The Radius of Curvature

The *radius of curvature* R at any point on a curve is defined as the absolute value of the reciprocal of the curvature K at that point.

$$R = \frac{1}{|K|} \quad (K \neq 0)$$

$$R = \left| \frac{[1 + (y')^2]^{3/2}}{y''} \right| \quad (y'' \neq 0)$$

L'Hospital's Rule (L'Hôpital's Rule)

If the fractional function $f(x)/g(x)$ assumes one of the indeterminate forms $0/0$ or ∞/∞ (where α is finite or infinite), then

$$\lim_{x \rightarrow \alpha} f(x)/g(x)$$

is equal to the first of the expressions

$$\lim_{x \rightarrow \alpha} \frac{f'(x)}{g'(x)}, \lim_{x \rightarrow \alpha} \frac{f''(x)}{g''(x)}, \lim_{x \rightarrow \alpha} \frac{f'''(x)}{g'''(x)}$$

which is not indeterminate, provided such first indicated limit exists.

Integral Calculus

The definite integral is defined as:

$$\lim_{n \rightarrow \infty} \sum_{i=1}^n f(x_i) \Delta x_i = \int_a^b f(x) dx$$

Also, $\Delta x_i \rightarrow 0$ for all i .

A table of derivatives and integrals is available in the Derivatives and Indefinite Integrals sections. The integral equations can be used along with the following methods of integration:

- A. Integration by Parts (integral equation #6),
- B. Integration by Substitution, and
- C. Separation of Rational Fractions into Partial Fractions.

Derivatives

In these formulas, u , v , and w represent functions of x . Also, a , c , and n represent constants. All arguments of the trigonometric functions are in radians. A constant of integration should be added to the integrals. The following definitions are followed: $\arcsin u = \sin^{-1} u$, $(\sin u)^{-1} = 1/\sin u$.

1. $dc/dx = 0$

2. $dx/dx = 1$

3. $d(cu)/dx = c du/dx$

4. $d(u + v - w)/dx = du/dx + dv/dx - dw/dx$

5. $d(uv)/dx = u dv/dx + v du/dx$

6. $d(uvw)/dx = uv dw/dx + uw dv/dx + vw du/dx$

7. $\frac{d(u/v)}{dx} = \frac{v du/dx - u dv/dx}{v^2}$

8. $d(u^n)/dx = nu^{n-1} du/dx$

9. $d[f(u)]/dx = \{d[f(u)]/du\} du/dx$

10. $du/dx = 1/(dx/du)$

11. $\frac{d(\log_a u)}{dx} = (\log_a e) \frac{1}{u} \frac{du}{dx}$

12. $\frac{d(\ln u)}{dx} = \frac{1}{u} \frac{du}{dx}$

13. $\frac{d(a^u)}{dx} = (\ln a) a^u \frac{du}{dx}$

14. $d(e^u)/dx = e^u du/dx$

15. $d(u^v)/dx = vu^{v-1} du/dx + (\ln u) u^v dv/dx$

16. $d(\sin u)/dx = \cos u du/dx$

17. $d(\cos u)/dx = -\sin u du/dx$

18. $d(\tan u)/dx = \sec^2 u du/dx$

19. $d(\cot u)/dx = -\csc^2 u du/dx$

20. $d(\sec u)/dx = \sec u \tan u du/dx$

21. $d(\csc u)/dx = -\csc u \cot u du/dx$

22. $\frac{d(\sin^{-1} u)}{dx} = \frac{1}{\sqrt{1-u^2}} \frac{du}{dx} \quad (-\pi/2 \leq \sin^{-1} u \leq \pi/2)$

23. $\frac{d(\cos^{-1} u)}{dx} = -\frac{1}{\sqrt{1-u^2}} \frac{du}{dx} \quad (0 \leq \cos^{-1} u \leq \pi)$

24. $\frac{d(\tan^{-1} u)}{dx} = \frac{1}{1+u^2} \frac{du}{dx} \quad (-\pi/2 < \tan^{-1} u < \pi/2)$

25. $\frac{d(\cot^{-1} u)}{dx} = -\frac{1}{1+u^2} \frac{du}{dx} \quad (0 < \cot^{-1} u < \pi)$

26. $\frac{d(\sec^{-1} u)}{dx} = \frac{1}{u\sqrt{u^2-1}} \frac{du}{dx} \quad (0 < \sec^{-1} u < \pi/2)(-\pi \leq \sec^{-1} u < -\pi/2)$

27. $\frac{d(\csc^{-1} u)}{dx} = -\frac{1}{u\sqrt{u^2-1}} \frac{du}{dx} \quad (0 < \csc^{-1} u \leq \pi/2)(-\pi < \csc^{-1} u \leq -\pi/2)$

Indefinite Integrals

1. $\int df(x) = f(x)$

2. $\int dx = x$

3. $\int a f(x) dx = a \int f(x) dx$

4. $\int [u(x) \pm v(x)] dx = \int u(x) dx \pm \int v(x) dx$

5. $\int x^m dx = \frac{x^{m+1}}{m+1} \quad (m \neq -1)$

6. $\int u(x) dv(x) = u(x)v(x) - \int v(x) du(x)$

7. $\int \frac{dx}{ax+b} = \frac{1}{a} \ln |ax+b|$

8. $\int \frac{dx}{\sqrt{x}} = 2\sqrt{x}$

9. $\int a^x dx = \frac{a^x}{\ln a}$

10. $\int \sin x dx = -\cos x$

11. $\int \cos x dx = \sin x$

12. $\int \sin^2 x dx = \frac{x}{2} - \frac{\sin 2x}{4}$

13. $\int \cos^2 x dx = \frac{x}{2} + \frac{\sin 2x}{4}$

14. $\int x \sin x dx = \sin x - x \cos x$

15. $\int x \cos x dx = \cos x + x \sin x$

16. $\int \sin x \cos x dx = (\sin^2 x)/2$

17. $\int \sin ax \cos bx dx = -\frac{\cos(a-b)x}{2(a-b)} - \frac{\cos(a+b)x}{2(a+b)} \quad (a^2 \neq b^2)$

18. $\int \tan x dx = -\ln |\cos x| = \ln |\sec x|$

19. $\int \cot x dx = -\ln |\csc x| = \ln |\sin x|$

20. $\int \tan^2 x dx = \tan x - x$

21. $\int \cot^2 x dx = -\cot x - x$

22. $\int e^{ax} dx = (1/a) e^{ax}$

23. $\int x e^{ax} dx = (e^{ax}/a^2)(ax - 1)$

24. $\int \ln x dx = x [\ln(x) - 1] \quad (x > 0)$

25. $\int \frac{dx}{a^2 + x^2} = \frac{1}{a} \tan^{-1} \frac{x}{a} \quad (a \neq 0)$

26. $\int \frac{dx}{ax^2 + c} = \frac{1}{\sqrt{ac}} \tan^{-1} \left(x \sqrt{\frac{a}{c}} \right), \quad (a > 0, c > 0)$

27a. $\int \frac{dx}{ax^2 + bx + c} = \frac{2}{\sqrt{4ac - b^2}} \tan^{-1} \frac{2ax + b}{\sqrt{4ac - b^2}} \quad (4ac - b^2 > 0)$

27b. $\int \frac{dx}{ax^2 + bx + c} = \frac{1}{\sqrt{b^2 - 4ac}} \ln \left| \frac{2ax + b - \sqrt{b^2 - 4ac}}{2ax + b + \sqrt{b^2 - 4ac}} \right| \quad (b^2 - 4ac > 0)$

27c. $\int \frac{dx}{ax^2 + bx + c} = -\frac{2}{2ax + b}, \quad (b^2 - 4ac = 0)$

Progression and Series

Arithmetic Progression

To determine whether a given finite sequence of numbers is an arithmetic progression, subtract each number from the following number. If the differences are equal, the series is arithmetic.

1. The first term is a .
2. The common difference is d .
3. The number of terms is n .
4. The last or n th term is l .
5. The sum of n terms is S .

$$l = a + (n - 1)d$$

$$S = n(a + l)/2 = n [2a + (n - 1) d]/2$$

Geometric Progression

To determine whether a given finite sequence is a geometric progression (G.P.), divide each number after the first by the preceding number. If the quotients are equal, the series is geometric:

1. The first term is a .
2. The common ratio is r .
3. The number of terms is n .
4. The last or n th term is l .
5. The sum of n terms is S .

$$l = ar^{n-1}$$

$$S = a (1 - r^n)/(1 - r); r \neq 1$$

$$S = (a - rl)/(1 - r); r \neq 1$$

$$\lim_{n \rightarrow \infty} S_n = a/(1 - r); r < 1$$

A G.P. converges if $|r| < 1$ and it diverges if $|r| > 1$.

Properties of Series

$$\sum_{i=1}^n c = nc; \quad c = \text{constant}$$

$$\sum_{i=1}^n cx_i = c \sum_{i=1}^n x_i$$

$$\sum_{i=1}^n (x_i + y_i - z_i) = \sum_{i=1}^n x_i + \sum_{i=1}^n y_i - \sum_{i=1}^n z_i$$

$$\sum_{x=1}^n x = (n + n^2)/2$$

$$\prod_{i=1}^n x_i = x_1 x_2 x_3 \dots x_n$$

Power Series

$$\sum_{i=0}^{\infty} a_i (x - a)^i$$

1. A power series, which is convergent in the interval $-R < x < R$, defines a function of x that is continuous for all values of x within the interval and is said to represent the function in that interval.
2. A power series may be differentiated term by term within its interval of convergence. The resulting series has the same interval of convergence as the original series (except possibly at the end points of the series).
3. A power series may be integrated term by term provided the limits of integration are within the interval of convergence of the series.
4. Two power series may be added, subtracted, or multiplied, and the resulting series in each case is convergent, at least, in the interval common to the two series.
5. Using the process of long division (as for polynomials), two power series may be divided one by the other within their common interval of convergence.

Taylor's Series

$$f(x) = f(a) + \frac{f'(a)}{1!}(x-a) + \frac{f''(a)}{2!}(x-a)^2 + \dots + \frac{f^{(n)}(a)}{n!}(x-a)^n + \dots$$

is called *Taylor's series*, and the function $f(x)$ is said to be expanded about the point a in a Taylor's series.

If $a = 0$, the Taylor's series equation becomes a *Maclaurin's series*.

Differential Equations

A common class of ordinary linear differential equations is

$$b_n \frac{d^n y(x)}{dx^n} + \dots + b_1 \frac{dy(x)}{dx} + b_0 y(x) = f(x)$$

where b_n, \dots, b_1, b_0 are constants.

When the equation is a homogeneous differential equation, $f(x) = 0$, the solution is

$$y_h(x) = C_1 e^{r_1 x} + C_2 e^{r_2 x} + \dots + C_i e^{r_i x} + \dots + C_n e^{r_n x}$$

where r_n is the n th distinct root of the characteristic polynomial $P(x)$ with

$$P(r) = b_n r^n + b_{n-1} r^{n-1} + \dots + b_1 r + b_0$$

If the root $r_1 = r_2$, then $C_2 e^{r_2 x}$ is replaced with $C_2 x e^{r_1 x}$.

Higher orders of multiplicity imply higher powers of x . The complete solution for the differential equation is

$$y(x) = y_h(x) + y_p(x),$$

where $y_p(x)$ is any particular solution with $f(x)$ present. If $f(x)$ has $e^{r_n x}$ terms, then resonance is manifested.

Furthermore, specific $f(x)$ forms result in specific $y_p(x)$ forms, some of which are:

$f(x)$	$y_p(x)$
A	B
$Ae^{\alpha x}$	$Be^{\alpha x}, \alpha \neq r_n$
$A_1 \sin \omega x + A_2 \cos \omega x$	$B_1 \sin \omega x + B_2 \cos \omega x$

If the independent variable is time t , then transient dynamic solutions are implied.

First-Order Linear Homogeneous Differential Equations with Constant Coefficients

$y' + ay = 0$, where a is a real constant:

Solution, $y = Ce^{-at}$

where $C =$ a constant that satisfies the initial conditions.

First-Order Linear Nonhomogeneous Differential Equations

$$\tau \frac{dy}{dt} + y = Kx(t) \quad x(t) = \begin{cases} A & t < 0 \\ B & t > 0 \end{cases}$$

$$y(0) = KA$$

τ is the time constant

K is the gain

The solution is

$$y(t) = KA + (KB - KA) \left(1 - \exp\left(-\frac{t}{\tau}\right) \right) \text{ or}$$

$$\frac{t}{\tau} = \ln \left[\frac{KB - KA}{KB - y} \right]$$

Second-Order Linear Homogeneous Differential Equations with Constant Coefficients

An equation of the form

$$y'' + ay' + by = 0$$

can be solved by the method of undetermined coefficients where a solution of the form $y = Ce^{rx}$ is sought. Substitution of this solution gives

$$(r^2 + ar + b) Ce^{rx} = 0$$

and since Ce^{rx} cannot be zero, the characteristic equation must vanish or

$$r^2 + ar + b = 0$$

The roots of the characteristic equation are

$$r_{1,2} = \frac{-a \pm \sqrt{a^2 - 4b}}{2}$$

and can be real and distinct for $a^2 > 4b$, real and equal for $a^2 = 4b$, and complex for $a^2 < 4b$.

If $a^2 > 4b$, the solution is of the form (overdamped)

$$y = C_1 e^{r_1 x} + C_2 e^{r_2 x}$$

If $a^2 = 4b$, the solution is of the form (critically damped)

$$y = (C_1 + C_2 x) e^{r_1 x}$$

If $a^2 < 4b$, the solution is of the form (underdamped)

$$y = e^{\alpha x} (C_1 \cos \beta x + C_2 \sin \beta x), \text{ where}$$

$$\alpha = -a/2$$

$$\beta = \frac{\sqrt{4b - a^2}}{2}$$

Fourier Transform

The Fourier transform pair, one form of which is

$$F(\omega) = \int_{-\infty}^{\infty} f(t) e^{-j\omega t} dt$$

$$f(t) = [1/(2\pi)] \int_{-\infty}^{\infty} F(\omega) e^{j\omega t} d\omega$$

can be used to characterize a broad class of signal models in terms of their frequency or spectral content. Some useful transform pairs are:

$f(t)$	$F(\omega)$
$\delta(t)$	1
$u(t)$	$\pi\delta(\omega) + 1/j\omega$
$u\left(t + \frac{\tau}{2}\right) - u\left(t - \frac{\tau}{2}\right) = r_{rect} \frac{t}{\tau}$	$\tau \frac{\sin(\omega\tau/2)}{\omega\tau/2}$
$e^{j\omega_0 t}$	$2\pi\delta(\omega - \omega_0)$

Some mathematical liberties are required to obtain the second and fourth form. Other Fourier transforms are derivable from the Laplace transform by replacing s with $j\omega$ provided

$$f(t) = 0, t < 0$$

$$\int_0^{\infty} |f(t)| dt < \infty$$

Fourier Series

Every periodic function $f(t)$ which has the period $T = 2\pi/\omega_0$ and has certain continuity conditions can be represented by a series plus a constant

$$f(t) = a_0 + \sum_{n=1}^{\infty} [a_n \cos(n\omega_0 t) + b_n \sin(n\omega_0 t)]$$

The above holds if $f(t)$ has a continuous derivative $f'(t)$ for all t . It should be noted that the various sinusoids present in the series are orthogonal on the interval 0 to T and as a result the coefficients are given by

$$a_0 = (1/T) \int_0^T f(t) dt$$

$$a_n = (2/T) \int_0^T f(t) \cos(n\omega_0 t) dt \quad n = 1, 2, \dots$$

$$b_n = (2/T) \int_0^T f(t) \sin(n\omega_0 t) dt \quad n = 1, 2, \dots$$

The constants a_n and b_n are the *Fourier coefficients* of $f(t)$ for the interval 0 to T and the corresponding series is called the *Fourier series of $f(t)$* over the same interval.

The integrals have the same value when evaluated over any interval of length T .

If a Fourier series representing a periodic function is truncated after term $n = N$ the mean square value F_N^2 of the truncated series is given by Parseval's relation. This relation says that the mean-square value is the sum of the mean-square values of the Fourier components, or

$$F_N^2 = a_0^2 + (1/2) \sum_{n=1}^N (a_n^2 + b_n^2)$$

and the RMS value is then defined to be the square root of this quantity or F_N .

Three useful and common Fourier series forms are defined in terms of the following graphs (with $\omega_0 = 2\pi/T$).

Given:

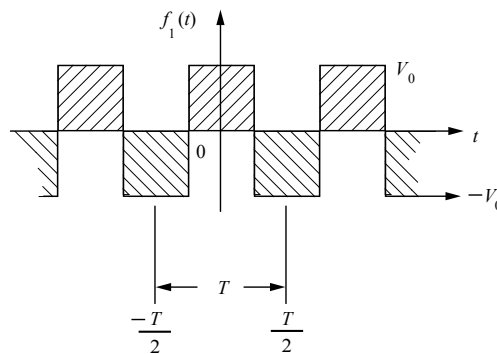

then

$$f_1(t) = \sum_{\substack{n=1 \\ (n \text{ odd})}}^{\infty} (-1)^{(n-1)/2} (4V_0/n\pi) \cos(n\omega_0 t)$$

Given:

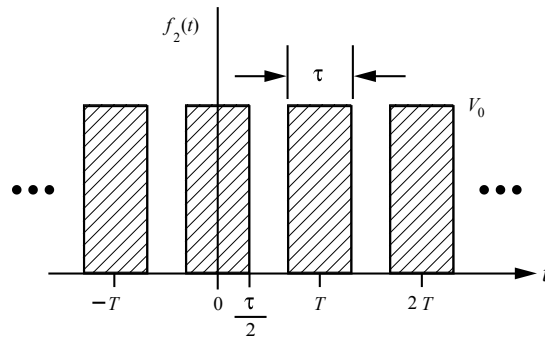

then

$$f_2(t) = \frac{V_0\tau}{T} + \frac{2V_0\tau}{T} \sum_{n=1}^{\infty} \frac{\sin(n\pi\tau/T)}{(n\pi\tau/T)} \cos(n\omega_0 t)$$

$$f_2(t) = \frac{V_0\tau}{T} \sum_{n=-\infty}^{\infty} \frac{\sin(n\pi\tau/T)}{(n\pi\tau/T)} e^{jn\omega_0 t}$$

Given:

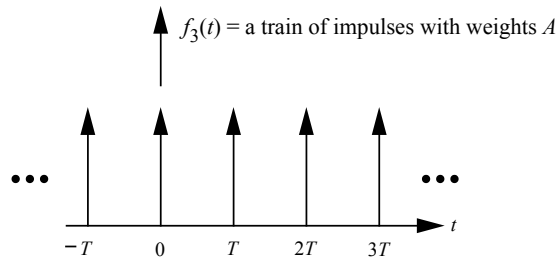

then

$$f_3(t) = \sum_{n=-\infty}^{\infty} A\delta(t - nT)$$

$$f_3(t) = (A/T) + (2A/T) \sum_{n=1}^{\infty} \cos(n\omega_0 t)$$

$$f_3(t) = (A/T) \sum_{n=-\infty}^{\infty} e^{jn\omega_0 t}$$

The Fourier Transform and its Inverse

$$X(f) = \int_{-\infty}^{+\infty} x(t) e^{-j2\pi ft} dt$$

$$x(t) = \int_{-\infty}^{+\infty} X(f) e^{j2\pi ft} df$$

We say that $x(t)$ and $X(f)$ form a *Fourier transform pair*:

$$x(t) \leftrightarrow X(f)$$

Fourier Transform Pairs

$x(t)$	$X(f)$
1	$\delta(f)$
$\delta(t)$	1
$u(t)$	$\frac{1}{2}\delta(f) + \frac{1}{j2\pi f}$
$\Pi\left(\frac{t}{\tau}\right)$	$\tau \operatorname{sinc}(\tau f)$
$\operatorname{sinc}(Bt)$	$\frac{1}{B}\Pi\left(\frac{f}{B}\right)$
$\Lambda\left(\frac{t}{\tau}\right)$	$\tau \operatorname{sinc}^2(\tau f)$
$e^{-at}u(t)$	$\frac{1}{a+j2\pi f} \quad a > 0$
$te^{-at}u(t)$	$\frac{2a}{a^2+(2\pi f)^2} \quad a > 0$
$e^{-d t }$	$\frac{2a}{a^2+(2\pi f)^2} \quad a > 0$
$e^{-(at)^2}$	$\frac{\sqrt{\pi}}{a}e^{-\left(\frac{\pi f}{a}\right)^2}$
$\cos(2\pi f_0 t + \theta)$	$\frac{1}{2}\left[e^{j\theta}\delta(f-f_0) + e^{-j\theta}\delta(f+f_0)\right]$
$\sin(2\pi f_0 t + \theta)$	$\frac{1}{2j}\left[e^{j\theta}\delta(f-f_0) - e^{-j\theta}\delta(f+f_0)\right]$
$\sum_{n=-\infty}^{n=+\infty} \delta(t-nT_s)$	$f_s \sum_{k=-\infty}^{k=+\infty} \delta(f-kf_s) \quad f_s = \frac{1}{T_s}$

Fourier Transform Theorems

Linearity	$ax(t) + by(t)$	$aX(f) + bY(f)$
Scale change	$x(at)$	$\frac{1}{ a }X\left(\frac{f}{a}\right)$
Time reversal	$x(-t)$	$X(-f)$
Duality	$X(t)$	$x(-f)$
Time shift	$x(t-t_0)$	$X(f)e^{-j2\pi f t_0}$
Frequency shift	$x(t)e^{j2\pi f_0 t}$	$X(f-f_0)$
Modulation	$x(t)\cos 2\pi f_0 t$	$\frac{1}{2}X(f-f_0) + \frac{1}{2}X(f+f_0)$
Multiplication	$x(t)y(t)$	$X(f)*Y(f)$
Convolution	$x(t)*y(t)$	$X(f)Y(f)$
Differentiation	$\frac{d^n x(t)}{dt^n}$	$(j2\pi f)^n X(f)$
Integration	$\int_{-\infty}^t x(\lambda)d\lambda$	$\frac{1}{j2\pi f}X(f) + \frac{1}{2}X(0)\delta(f)$

where:

$$\operatorname{sinc}(t) = \frac{\sin(\pi t)}{\pi t}$$

$$\Pi(t) = \begin{cases} 1, & |t| \leq \frac{1}{2} \\ 0, & \text{otherwise} \end{cases}$$

$$\Lambda(t) = \begin{cases} 1-|t|, & |t| \leq 1 \\ 0, & \text{otherwise} \end{cases}$$

Laplace Transforms

The unilateral Laplace transform pair

$$F(s) = \int_0^{\infty} f(t) e^{-st} dt$$

$$f(t) = \frac{1}{2\pi j} \int_{\sigma-j\infty}^{\sigma+j\infty} F(s) e^{st} ds$$

where $s = \sigma + j\omega$

represents a powerful tool for the transient and frequency response of linear time invariant systems. Some useful Laplace transform pairs are:

Laplace Transform Pairs

$f(t)$	$F(s)$
$\delta(t)$, Impulse at $t = 0$	1
$u(t)$, Step at $t = 0$	$\frac{1}{s}$
$t[u(t)]$, Ramp at $t = 0$	$\frac{1}{s^2}$
e^{-at}	$\frac{1}{(s+a)}$
te^{-at}	$\frac{1}{(s+a)^2}$
$e^{-\alpha t} \sin \beta t$	$\frac{\beta}{[(s+\alpha)^2 + \beta^2]}$
$e^{-\alpha t} \cos \beta t$	$\frac{(s+\alpha)}{[(s+\alpha)^2 + \beta^2]}$
$\frac{d^n f(t)}{dt^n}$	$s^n F(s) - \sum_{m=0}^{n-1} s^{n-m-1} \frac{d^m f(0)}{dt^m}$
$\int_0^t f(\tau) d\tau$	$\left(\frac{1}{s}\right)F(s)$
$\int_0^t x(t-\tau)h(\tau) d\tau$	$H(s)X(s)$
$f(t-\tau)u(t-\tau)$	$e^{-\tau s}F(s)$
$\lim_{t \rightarrow \infty} f(t)$	$\lim_{s \rightarrow 0} sF(s)$
$\lim_{t \rightarrow 0} f(t)$	$\lim_{s \rightarrow \infty} sF(s)$

The last two transforms represent the Final Value Theorem (F.V.T.) and Initial Value Theorem (I.V.T.), respectively. It is assumed that the limits exist.

Matrices

A matrix is an ordered rectangular array of numbers with m rows and n columns. The element a_{ij} refers to row i and column j . The rank of a matrix is equal to the number of rows that are linearly independent.

Multiplication of Two Matrices

$$A = \begin{bmatrix} A & B \\ C & D \\ E & F \end{bmatrix} \quad A_{3,2} \text{ is a 3-row, 2-column matrix}$$

$$B = \begin{bmatrix} H & I \\ J & K \end{bmatrix} \quad B_{2,2} \text{ is a 2-row, 2-column matrix}$$

In order for multiplication to be possible, the number of columns in A must equal the number of rows in B.

Multiplying matrix B by matrix A occurs as follows:

$$C = \begin{bmatrix} A & B \\ C & D \\ E & F \end{bmatrix} \cdot \begin{bmatrix} H & I \\ J & K \end{bmatrix}$$

$$C = \begin{bmatrix} (A \cdot H + B \cdot J) & (A \cdot I + B \cdot K) \\ (C \cdot H + D \cdot J) & (C \cdot I + D \cdot K) \\ (E \cdot H + F \cdot J) & (E \cdot I + F \cdot K) \end{bmatrix}$$

Matrix multiplication is not commutative.

Addition of Two Matrices

$$\begin{bmatrix} A & B & C \\ D & E & F \end{bmatrix} + \begin{bmatrix} G & H & I \\ J & K & L \end{bmatrix} = \begin{bmatrix} A+G & B+H & C+I \\ D+J & E+K & F+L \end{bmatrix}$$

Identity Matrix

The matrix $\mathbf{I} = (a_{ij})$ is a square $n \times n$ matrix with 1's on the diagonal and 0's everywhere else.

Matrix Transpose

Rows become columns. Columns become rows.

$$A = \begin{bmatrix} A & B & C \\ D & E & F \end{bmatrix} \quad A^T = \begin{bmatrix} A & D \\ B & E \\ C & F \end{bmatrix}$$

Inverse $[\]^{-1}$

The inverse B of a square $n \times n$ matrix A is

$$B = A^{-1} = \frac{\text{adj}(A)}{|A|}$$

where

$\text{adj}(A)$ = adjoint of A (obtained by replacing A^T elements with their cofactors)

$|A|$ = determinant of A

$$[A][A]^{-1} = [A]^{-1}[A] = [I]$$

where \mathbf{I} is the identity matrix.

Matrix Properties

Suppose A is $N \times N$ over real numbers. Then if one of the following is true, all are true. If one of the following is false, all are false.

1. A is nonsingular.
2. A has an inverse.
3. $A \cdot X = 0$ has a unique solution.
4. Determinant of A is not equal to zero.
5. Columns of A are linearly independent.
6. Rows of A are linearly independent.
7. Rank of A is N .
8. A is row equivalent to I (identity matrix).
9. Null Space of $A = \{0\}$.

Cullen, C., *Matrices and Linear Transformations*. Reading, Massachusetts: Addison-Wesley, 1967.

Determinants

A *determinant of order n* consists of n^2 numbers, called the *elements* of the determinant, arranged in n rows and n columns and enclosed by two vertical lines.

In any determinant, the *minor* of a given element is the determinant that remains after all of the elements are struck out that lie in the same row and in the same column as the given element. Consider an element which lies in the j th column and the i th row. The *cofactor* of this element is the value of the minor of the element (if $i + j$ is *even*), and it is the negative of the value of the minor of the element (if $i + j$ is *odd*).

If n is greater than 1, the *value* of a determinant of order n is the sum of the n products formed by multiplying each element of some specified row (or column) by its cofactor. This sum is called the *expansion of the determinant* [according to the elements of the specified row (or column)]. For a second-order determinant:

$$\begin{vmatrix} a_1 & a_2 \\ b_1 & b_2 \end{vmatrix} = a_1 b_2 - a_2 b_1$$

For a third-order determinant:

$$\begin{vmatrix} a_1 & a_2 & a_3 \\ b_1 & b_2 & b_3 \\ c_1 & c_2 & c_3 \end{vmatrix} = a_1 b_2 c_3 + a_2 b_3 c_1 + a_3 b_1 c_2 - a_3 b_2 c_1 - a_2 b_1 c_3 - a_1 b_3 c_2$$

Vectors

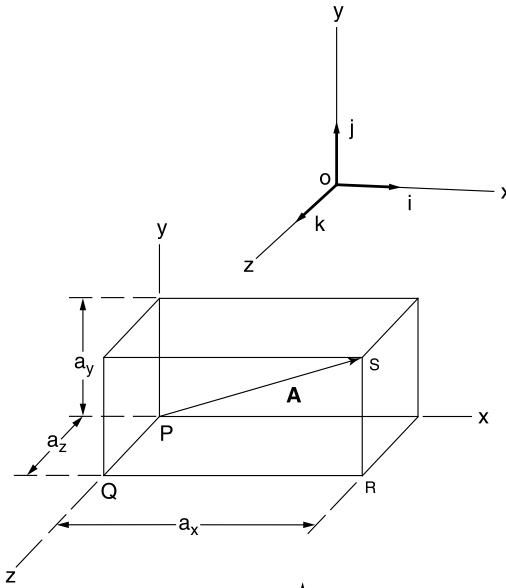

$$\mathbf{A} = a_x \mathbf{i} + a_y \mathbf{j} + a_z \mathbf{k}$$

Addition and subtraction:

$$\mathbf{A} + \mathbf{B} = (a_x + b_x)\mathbf{i} + (a_y + b_y)\mathbf{j} + (a_z + b_z)\mathbf{k}$$

$$\mathbf{A} - \mathbf{B} = (a_x - b_x)\mathbf{i} + (a_y - b_y)\mathbf{j} + (a_z - b_z)\mathbf{k}$$

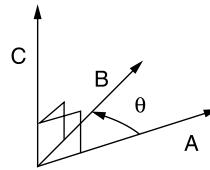

The *dot product* is a *scalar product* and represents the projection of **B** onto **A** times $|\mathbf{A}|$. It is given by

$$\mathbf{A} \cdot \mathbf{B} = a_x b_x + a_y b_y + a_z b_z = |\mathbf{A}| |\mathbf{B}| \cos \theta = \mathbf{B} \cdot \mathbf{A}$$

The *cross product* is a *vector product* of magnitude $|\mathbf{B}| |\mathbf{A}| \sin \theta$ which is perpendicular to the plane containing **A** and **B**. The product is

$$\mathbf{A} \times \mathbf{B} = \begin{vmatrix} \mathbf{i} & \mathbf{j} & \mathbf{k} \\ a_x & a_y & a_z \\ b_x & b_y & b_z \end{vmatrix} = - \mathbf{B} \times \mathbf{A}$$

The sense of $\mathbf{A} \times \mathbf{B}$ is determined by the right-hand rule.

$$\mathbf{A} \times \mathbf{B} = |\mathbf{A}| |\mathbf{B}| \mathbf{n} \sin \theta$$

where

\mathbf{n} = unit vector perpendicular to the plane of **A** and **B**

Gradient, Divergence, and Curl

$$\nabla \phi = \left(\frac{\partial}{\partial x} \mathbf{i} + \frac{\partial}{\partial y} \mathbf{j} + \frac{\partial}{\partial z} \mathbf{k} \right) \phi$$

$$\nabla \cdot \mathbf{V} = \left(\frac{\partial}{\partial x} \mathbf{i} + \frac{\partial}{\partial y} \mathbf{j} + \frac{\partial}{\partial z} \mathbf{k} \right) \cdot (V_1 \mathbf{i} + V_2 \mathbf{j} + V_3 \mathbf{k})$$

$$\nabla \times \mathbf{V} = \left(\frac{\partial}{\partial x} \mathbf{i} + \frac{\partial}{\partial y} \mathbf{j} + \frac{\partial}{\partial z} \mathbf{k} \right) \times (V_1 \mathbf{i} + V_2 \mathbf{j} + V_3 \mathbf{k})$$

The Laplacian of a scalar function ϕ is

$$\nabla^2 \phi = \frac{\partial^2 \phi}{\partial x^2} + \frac{\partial^2 \phi}{\partial y^2} + \frac{\partial^2 \phi}{\partial z^2}$$

Identities

$$\mathbf{A} \cdot \mathbf{B} = \mathbf{B} \cdot \mathbf{A}; \mathbf{A} \cdot (\mathbf{B} + \mathbf{C}) = \mathbf{A} \cdot \mathbf{B} + \mathbf{A} \cdot \mathbf{C}$$

$$\mathbf{A} \cdot \mathbf{A} = |\mathbf{A}|^2$$

$$\mathbf{i} \cdot \mathbf{i} = \mathbf{j} \cdot \mathbf{j} = \mathbf{k} \cdot \mathbf{k} = 1$$

$$\mathbf{i} \cdot \mathbf{j} = \mathbf{j} \cdot \mathbf{k} = \mathbf{k} \cdot \mathbf{i} = 0$$

If $\mathbf{A} \cdot \mathbf{B} = 0$, then either $\mathbf{A} = 0$, $\mathbf{B} = 0$, or \mathbf{A} is perpendicular to \mathbf{B} .

$$\mathbf{A} \times \mathbf{B} = -\mathbf{B} \times \mathbf{A}$$

$$\mathbf{A} \times (\mathbf{B} + \mathbf{C}) = (\mathbf{A} \times \mathbf{B}) + (\mathbf{A} \times \mathbf{C})$$

$$(\mathbf{B} + \mathbf{C}) \times \mathbf{A} = (\mathbf{B} \times \mathbf{A}) + (\mathbf{C} \times \mathbf{A})$$

$$\mathbf{i} \times \mathbf{i} = \mathbf{j} \times \mathbf{j} = \mathbf{k} \times \mathbf{k} = \mathbf{0}$$

$$\mathbf{i} \times \mathbf{j} = \mathbf{k} = -\mathbf{j} \times \mathbf{i}; \mathbf{j} \times \mathbf{k} = \mathbf{i} = -\mathbf{k} \times \mathbf{j}$$

$$\mathbf{k} \times \mathbf{i} = \mathbf{j} = -\mathbf{i} \times \mathbf{k}$$

If $\mathbf{A} \times \mathbf{B} = \mathbf{0}$, then either $\mathbf{A} = \mathbf{0}$, $\mathbf{B} = \mathbf{0}$, or \mathbf{A} is parallel to \mathbf{B} .

$$\nabla^2 \phi = \nabla \cdot (\nabla \phi) = (\nabla \cdot \nabla) \phi$$

$$\nabla \times \nabla \phi = \mathbf{0}$$

$$\nabla \cdot (\nabla \times \mathbf{A}) = \mathbf{0}$$

$$\nabla \times (\nabla \times \mathbf{A}) = \nabla(\nabla \cdot \mathbf{A}) - \nabla^2 \mathbf{A}$$

Numerical Methods

Difference Equations

Any system whose input $v(t)$ and output $y(t)$ are defined only at the equally spaced intervals

$$f(t) = y' = \frac{y_{i+1} - y_i}{t_{i+1} - t_i}$$

can be described by a difference equation.

First-Order Linear Difference Equation

$$\Delta t = t_{i+1} - t_i$$

$$y_{i+1} = y_i + y'(\Delta t)$$

Newton's Method for Root Extraction

Given a function $f(x)$ which has a simple root of $f(x) = 0$ at

$x = a$ an important computational task would be to find that root. If $f(x)$ has a continuous first derivative then the $(j + 1)$ st estimate of the root is

$$a^{j+1} = a^j - \frac{f(x)}{\frac{df(x)}{dx}} \Bigg|_{x = a^j}$$

The initial estimate of the root a^0 must be near enough to the actual root to cause the algorithm to converge to the root.

Newton's Method of Minimization

Given a scalar value function

$$h(\mathbf{x}) = h(x_1, x_2, \dots, x_n)$$

find a vector $\mathbf{x}^* \in R_n$ such that

$$h(\mathbf{x}^*) \leq h(\mathbf{x}) \text{ for all } \mathbf{x}$$

Newton's algorithm is

$$\mathbf{x}_{k+1} = \mathbf{x}_k - \left(\frac{\partial^2 h}{\partial \mathbf{x}^2} \bigg|_{\mathbf{x} = \mathbf{x}_k} \right)^{-1} \frac{\partial h}{\partial \mathbf{x}} \bigg|_{\mathbf{x} = \mathbf{x}_k}, \text{ where}$$

$$\frac{\partial h}{\partial \mathbf{x}} = \begin{bmatrix} \frac{\partial h}{\partial x_1} \\ \frac{\partial h}{\partial x_2} \\ \dots \\ \dots \\ \frac{\partial h}{\partial x_n} \end{bmatrix}$$

and

$$\frac{\partial^2 h}{\partial \mathbf{x}^2} = \begin{bmatrix} \frac{\partial^2 h}{\partial x_1^2} & \frac{\partial^2 h}{\partial x_1 \partial x_2} & \dots & \dots & \frac{\partial^2 h}{\partial x_1 \partial x_n} \\ \frac{\partial^2 h}{\partial x_1 \partial x_2} & \frac{\partial^2 h}{\partial x_2^2} & \dots & \dots & \frac{\partial^2 h}{\partial x_2 \partial x_n} \\ \dots & \dots & \dots & \dots & \dots \\ \dots & \dots & \dots & \dots & \dots \\ \frac{\partial^2 h}{\partial x_1 \partial x_n} & \frac{\partial^2 h}{\partial x_2 \partial x_n} & \dots & \dots & \frac{\partial^2 h}{\partial x_n^2} \end{bmatrix}$$

Numerical Integration

Three of the more common numerical integration algorithms used to evaluate the integral

$$\int_a^b f(x) dx$$

are:

Euler's or Forward Rectangular Rule

$$\int_a^b f(x) dx \approx \Delta x \sum_{k=0}^{n-1} f(a + k\Delta x)$$

Trapezoidal Rule

for $n = 1$

$$\int_a^b f(x) dx \approx \Delta x \left[\frac{f(a) + f(b)}{2} \right]$$

for $n > 1$

$$\int_a^b f(x) dx \approx \frac{\Delta x}{2} \left[f(a) + 2 \sum_{k=1}^{n-1} f(a + k\Delta x) + f(b) \right]$$

Simpson's Rule/Parabolic Rule (n must be an even integer)

for $n = 2$

$$\int_a^b f(x) dx \approx \left(\frac{b-a}{6}\right) \left[f(a) + 4f\left(\frac{a+b}{2}\right) + f(b) \right]$$

for $n \geq 4$

$$\int_a^b f(x) dx \approx \frac{\Delta x}{3} \left[f(a) + 2 \sum_{k=2,4,6,\dots}^{n-2} f(a+k\Delta x) + 4 \sum_{k=1,3,5,\dots}^{n-1} f(a+k\Delta x) + f(b) \right]$$

with $\Delta x = (b-a)/n$

n = number of intervals between data points

Numerical Solution of Ordinary Differential Equations

Euler's Approximation

Given a differential equation

$$dx/dt = f(x, t) \text{ with } x(0) = x_0$$

At some general time $k\Delta t$

$$x[(k+1)\Delta t] \cong x(k\Delta t) + \Delta t f[x(k\Delta t), k\Delta t]$$

which can be used with starting condition x_0 to solve recursively for $x(\Delta t), x(2\Delta t), \dots, x(n\Delta t)$.

The method can be extended to n th order differential equations by recasting them as n first-order equations.

In particular, when $dx/dt = f(x)$

$$x[(k+1)\Delta t] \cong x(k\Delta t) + \Delta t f[x(k\Delta t)]$$

which can be expressed as the recursive equation

$$x_{k+1} = x_k + \Delta t (dx_k/dt)$$

$$x_{k+1} = x_k + \Delta t [f(x(k), t(k))]$$

Engineering Probability and Statistics

Dispersion, Mean, Median, and Mode Values

If X_1, X_2, \dots, X_n represent the values of a random sample of n items or observations, the *arithmetic mean* of these items or observations, denoted \bar{X} , is defined as

$$\bar{X} = (1/n)(X_1 + X_2 + \dots + X_n) = (1/n) \sum_{i=1}^n X_i$$

$\bar{X} \rightarrow \mu$ for sufficiently large values of n .

The *weighted arithmetic mean* is

$$\bar{X}_w = \frac{\sum w_i X_i}{\sum w_i}$$

where

X_i = the value of the i th observation, and

w_i = the weight applied to X_i .

The *variance* of the population is the *arithmetic mean* of the *squared deviations from the population mean*. If μ is the arithmetic mean of a discrete population of size N , the *population variance* is defined by

$$\begin{aligned} \sigma^2 &= (1/N) \left[(X_1 - \mu)^2 + (X_2 - \mu)^2 + \dots + (X_N - \mu)^2 \right] \\ &= (1/N) \sum_{i=1}^N (X_i - \mu)^2 \end{aligned}$$

Standard deviation formulas (assuming statistical independence) are

$$\sigma_{\text{population}} = \sqrt{(1/N) \sum (X_i - \mu)^2}$$

$$\sigma_{\text{sum}} = \sqrt{\sigma_1^2 + \sigma_2^2 + \dots + \sigma_n^2}$$

$$\sigma_{\text{series}} = \sigma \sqrt{n}$$

$$\sigma_{\text{mean}} = \frac{\sigma}{\sqrt{n}}$$

$$\sigma_{\text{product}} = \sqrt{A^2 \sigma_b^2 + B^2 \sigma_a^2}$$

The *sample variance* is

$$s^2 = \left[1/(n-1) \right] \sum_{i=1}^n (X_i - \bar{X})^2$$

The *sample standard deviation* is

$$s = \sqrt{\left[1/(n-1) \right] \sum_{i=1}^n (X_i - \bar{X})^2}$$

The *sample coefficient of variation* = $CV = s/\bar{X}$

The *sample geometric mean* = $\sqrt[n]{X_1 X_2 X_3 \dots X_n}$

The *sample root-mean-square value* = $\sqrt{(1/n) \sum X_i^2}$

When the discrete data are rearranged in increasing order and n is odd, the median is the value of the $\left(\frac{n+1}{2}\right)^{\text{th}}$ item

When n is even, the median is the average of the $\left(\frac{n}{2}\right)^{\text{th}}$ and $\left(\frac{n}{2} + 1\right)^{\text{th}}$ items.

The *mode* of a set of data is the value that occurs with greatest frequency.

The *sample range* R is the largest sample value minus the smallest sample value.

Permutations and Combinations

A *permutation* is a particular sequence of a given set of objects. A *combination* is the set itself without reference to order.

1. The number of different *permutations* of n distinct objects *taken r at a time* is

$$P(n, r) = \frac{n!}{(n - r)!}$$

nPr is an alternative notation for $P(n, r)$

2. The number of different *combinations* of n distinct objects *taken r at a time* is

$$C(n, r) = \frac{P(n, r)}{r!} = \frac{n!}{[r!(n - r)!]}$$

nCr and $\binom{n}{r}$ are alternative notations for $C(n, r)$

3. The number of different *permutations* of n objects *taken n at a time*, given that n_i are of type i , where $i = 1, 2, \dots, k$ and $\sum n_i = n$, is

$$P(n; n_1, n_2, \dots, n_k) = \frac{n!}{n_1! n_2! \dots n_k!}$$

Sets

De Morgan's Law

$$\overline{A \cup B} = \bar{A} \cap \bar{B}$$

$$\overline{A \cap B} = \bar{A} \cup \bar{B}$$

Associative Law

$$A \cup (B \cap C) = (A \cup B) \cap C$$

$$A \cap (B \cup C) = (A \cap B) \cup C$$

Distributive Law

$$A \cup (B \cap C) = (A \cup B) \cap (A \cup C)$$

$$A \cap (B \cup C) = (A \cap B) \cup (A \cap C)$$

Laws of Probability

Property 1. General Character of Probability

The probability $P(E)$ of an event E is a real number in the range of 0 to 1. The probability of an impossible event is 0 and that of an event certain to occur is 1.

Property 2. Law of Total Probability

$$P(A + B) = P(A) + P(B) - P(A, B)$$

where

$P(A + B)$ = the probability that either A or B occur alone or that both occur together

$P(A)$ = the probability that A occurs

$P(B)$ = the probability that B occurs

$P(A, B)$ = the probability that both A and B occur simultaneously

Property 3. Law of Compound or Joint Probability

If neither $P(A)$ nor $P(B)$ is zero,

$$P(A, B) = P(A)P(B | A) = P(B)P(A | B)$$

where

$P(B | A)$ = the probability that B occurs given the fact that A has occurred

$P(A | B)$ = the probability that A occurs given the fact that B has occurred

If either $P(A)$ or $P(B)$ is zero, then $P(A, B) = 0$.

Bayes' Theorem

$$P(B_j | A) = \frac{P(B_j)P(A | B_j)}{\sum_{i=1}^n P(A | B_i)P(B_i)}$$

where

$P(A_j)$ = the probability of event A_j within the population of A

$P(B_j)$ = the probability of event B_j within the population of B

Probability Functions, Distributions, and Expected Values

A random variable X has a probability associated with each of its possible values. The probability is termed a discrete probability if X can assume only discrete values, or

$$X = x_1, x_2, x_3, \dots, x_n$$

The *discrete probability* of any single event, $X = x_i$, occurring is defined as $P(x_i)$ while the *probability mass function* of the random variable X is defined by

$$f(x_k) = P(X = x_k), k = 1, 2, \dots, n$$

Probability Density Function

If X is continuous, the *probability density function*, f , is defined such that

$$P(a \leq X \leq b) = \int_a^b f(x) dx$$

Cumulative Distribution Functions

The *cumulative distribution function*, F , of a discrete random variable X that has a probability distribution described by $P(x_i)$ is defined as

$$F(x_m) = \sum_{k=1}^m P(x_k) = P(X \leq x_m), m = 1, 2, \dots, n$$

If X is continuous, the *cumulative distribution function*, F , is defined by

$$F(x) = \int_{-\infty}^x f(x) dx$$

which implies that $F(a)$ is the probability that $X \leq a$.

Expected Values

Let X be a discrete random variable having a probability mass function

$$f(x_k), k = 1, 2, \dots, n$$

The expected value of X is defined as

$$\mu = E[X] = \sum_{k=1}^n x_k f(x_k)$$

The variance of X is defined as

$$\sigma^2 = V[X] = \sum_{k=1}^n (x_k - \mu)^2 f(x_k)$$

Let X be a continuous random variable having a density function $f(X)$ and let $Y = g(X)$ be some general function. The expected value of Y is:

$$E[Y] = E[g(X)] = \int_{-\infty}^{\infty} g(x)f(x) dx$$

The mean or expected value of the random variable X is now defined as

$$\mu = E[X] = \int_{-\infty}^{\infty} xf(x) dx$$

while the variance is given by

$$\sigma^2 = V[X] = E[(X - \mu)^2] = E[x^2] - \mu^2 = \int_{-\infty}^{\infty} (x - \mu)^2 f(x) dx$$

The standard deviation is given by

$$\sigma = \sqrt{V[X]}$$

The coefficient of variation is defined as σ/μ .

Combinations of Random Variables

$$Y = a_1 X_1 + a_2 X_2 + \dots + a_n X_n$$

The expected value of Y is:

$$\mu_y = E(Y) = a_1 E(X_1) + a_2 E(X_2) + \dots + a_n E(X_n)$$

If the random variables are statistically *independent*, then the variance of Y is:

$$\begin{aligned} \sigma_y^2 &= V(Y) = a_1^2 V(X_1) + a_2^2 V(X_2) + \dots + a_n^2 V(X_n) \\ &= a_1^2 \sigma_1^2 + a_2^2 \sigma_2^2 + \dots + a_n^2 \sigma_n^2 \end{aligned}$$

Also, the standard deviation of Y is:

$$\sigma_y = \sqrt{\sigma_y^2}$$

When $Y = f(X_1, X_2, \dots, X_n)$ and X_i are independent, the standard deviation of Y is expressed as:

$$\sigma_y = \sqrt{\left(\frac{\partial f}{\partial X_1} \sigma_{X_1}\right)^2 + \left(\frac{\partial f}{\partial X_2} \sigma_{X_2}\right)^2 + \dots + \left(\frac{\partial f}{\partial X_n} \sigma_{X_n}\right)^2}$$

Binomial Distribution

$P(x)$ is the probability that x successes will occur in n trials.

If p = probability of success and q = probability of failure = $1 - p$, then

$$P_n(x) = C(n, x) p^x q^{n-x} = \frac{n!}{x!(n-x)!} p^x q^{n-x}$$

where

$$x = 0, 1, 2, \dots, n$$

$C(n, x)$ = number of combinations

n, p = parameters

The variance is given by the form:

$$\sigma^2 = npq$$

Normal Distribution (Gaussian Distribution)

This is a unimodal distribution, the mode being $x = \mu$, with two points of inflection (each located at a distance σ to either side of the mode). The averages of n observations tend to become normally distributed as n increases. The variate x is said to be normally distributed if its density function $f(x)$ is given by an expression of the form

$$f(x) = \frac{1}{\sigma\sqrt{2\pi}} e^{-\frac{1}{2}\left(\frac{x-\mu}{\sigma}\right)^2}$$

where

μ = population mean

σ = standard deviation of the population

$$-\infty \leq x \leq \infty$$

When $\mu = 0$ and $\sigma^2 = \sigma = 1$, the distribution is called a *standardized* or *unit normal* distribution. Then

$$f(x) = \frac{1}{\sqrt{2\pi}} e^{-x^2/2}, \text{ where } -\infty \leq x \leq \infty.$$

A unit normal distribution table is included at the end of this section. In the table, the following notations are utilized:

$F(x)$ = area under the curve from $-\infty$ to x

$R(x)$ = area under the curve from x to ∞

$W(x)$ = area under the curve between $-x$ and x

$$F(-x) = 1 - F(x)$$

It should be noted that for any normal distribution with mean μ and standard deviation σ , the table for the unit normal distribution can be used by utilizing the following transformation:

$$z = \frac{x - \mu}{\sigma}$$

$f(x)$ then becomes $f(z)$, $F(x)$ becomes $F(z)$, etc.

The Central Limit Theorem

Let X_1, X_2, \dots, X_n be a sequence of independent and identically distributed random variables each having mean μ and variance σ^2 . Then for large n , the Central Limit Theorem asserts that the sum

$Y = X_1 + X_2 + \dots + X_n$ is approximately normal.

$$\mu_{\bar{y}} = \mu$$

and the standard deviation

$$\sigma_{\bar{y}} = \frac{\sigma}{\sqrt{n}}$$

t-Distribution

Student's t -distribution has the probability density function given by:

$$f(t) = \frac{\Gamma\left(\frac{\nu+1}{2}\right)}{\sqrt{\nu\pi}\Gamma\left(\frac{\nu}{2}\right)} \left(1 + \frac{t^2}{\nu}\right)^{-\frac{\nu+1}{2}}$$

where

ν = number of degrees of freedom

n = sample size

$\nu = n - 1$

Γ = gamma function

$$t = \frac{\bar{x} - \mu}{s/\sqrt{n}}$$

$$-\infty \leq t \leq \infty$$

A table later in this section gives the values of $t_{\alpha, \nu}$ for values of α and ν . Note that, in view of the symmetry of the t -distribution, $t_{1-\alpha, \nu} = -t_{\alpha, \nu}$

The function for α follows:

$$\alpha = \int_{t_{\alpha, \nu}}^{\infty} f(t) dt$$

χ^2 - Distribution

If Z_1, Z_2, \dots, Z_n are independent unit normal random variables, then

$$\chi^2 = Z_1^2 + Z_2^2 + \dots + Z_n^2$$

is said to have a chi-square distribution with n degrees of freedom.

A table at the end of this section gives values of $\chi_{\alpha, n}^2$ for selected values of α and n .

Gamma Function

$$\Gamma(n) = \int_0^{\infty} t^{n-1} e^{-t} dt, n > 0$$

Propagation of Error

Measurement Error

Measurement error is defined as: *Measured quantity value minus a reference quantity value.* [Source: ISO JCGM 200:2012 definition 2.16]

Sources of errors in measurements arise from imperfections and disturbances in the measurement process, and added noise. One may model a measurement as:

$$x = x_{\text{ref}} + d_{\text{systematic}} + d_{\text{random}}$$

where x is the measurand (value being measured), x_{ref} is the reference value, $d_{\text{systematic}}$ is a disturbance from the measurement process such as a drift or bias, and d_{random} is a disturbance such as random noise.

Linear Combinations

In mathematics, a linear combination is an expression constructed from a set of terms by multiplying each term by a constant and adding the results (e.g., if z is a linear combination of x and y , then $z = ax+by$ where a and b are constants).

See the section "Combinations of Random Variables" for how variances and standard deviations of random variables combine.

Measurement Uncertainty

Measurement uncertainty is defined as: *A quantitative estimate of the range of values about the reported or measured value in which the true value is believed to lie.* [Source: ISO JCGM 200:2012, definition 2.26]

Given a desired state or measurement y , which is a function of different measured or available states x_i :

$$y = f(x_1, x_2, \dots, x_n)$$

Given the individual states x_i and their standard deviations σ_{x_i} , and assuming that the different x_i are uncorrelated, the Kline-McClintock equation can be used to compute the expected standard uncertainty of y (σ_y) is:

$$\sigma_y = \sqrt{\left(\frac{\partial f}{\partial x_1}\right)^2 \sigma_{x_1}^2 + \left(\frac{\partial f}{\partial x_2}\right)^2 \sigma_{x_2}^2 + \dots + \left(\frac{\partial f}{\partial x_n}\right)^2 \sigma_{x_n}^2}$$

Expanded uncertainties are typically given at an approximately 95% level of confidence with a coverage factor of $k = 2$. This represents 95% of the area under a Normal probability distribution and is often called 2 sigma.

Linear Regression and Goodness of Fit

Least Squares

$$\hat{y} = \hat{a} + \hat{b}x$$

where

$$\hat{b} = S_{xy}/S_{xx}$$

$$\hat{a} = \bar{y} - \hat{b}\bar{x}$$

$$S_{xy} = \sum_{i=1}^n x_i y_i - (1/n) \left(\sum_{i=1}^n x_i \right) \left(\sum_{i=1}^n y_i \right)$$

$$S_{xx} = \sum_{i=1}^n x_i^2 - (1/n) \left(\sum_{i=1}^n x_i \right)^2$$

$$\bar{y} = (1/n) \left(\sum_{i=1}^n y_i \right)$$

$$\bar{x} = (1/n) \left(\sum_{i=1}^n x_i \right)$$

where

n = sample size

S_{xx} = sum of squares of x

S_{yy} = sum of squares of y

S_{xy} = sum of x - y products

Residual

$$e_i = y_i - \hat{y} = y_i - (\hat{a} + \hat{b}x_i)$$

Standard Error of Estimate (S_e^2):

$$S_e^2 = \frac{S_{xx}S_{yy} - S_{xy}^2}{S_{xx}(n-2)} = MSE$$

where

$$S_{yy} = \sum_{i=1}^n y_i^2 - (1/n) \left(\sum_{i=1}^n y_i \right)^2$$

Confidence Interval for Intercept (\hat{a}):

$$\hat{a} \pm t_{\alpha/2, n-2} \sqrt{\left(\frac{1}{n} + \frac{\bar{x}^2}{S_{xx}} \right) MSE}$$

Confidence Interval for Slope (\hat{b}):

$$\hat{b} \pm t_{\alpha/2, n-2} \sqrt{\frac{MSE}{S_{xx}}}$$

Sample Correlation Coefficient (R) and Coefficient of Determination (R^2):

$$R = \frac{S_{xy}}{\sqrt{S_{xx}S_{yy}}}$$

$$R^2 = \frac{S_{xy}^2}{S_{xx}S_{yy}}$$

Hypothesis Testing

Let a "dot" subscript indicate summation over the subscript. Thus:

$$y_{i\cdot} = \sum_{j=1}^n y_{ij} \quad \text{and} \quad y_{\cdot\cdot} = \sum_{i=1}^a \sum_{j=1}^n y_{ij}$$

One-Way Analysis of Variance (ANOVA)

Given independent random samples of size n_i from k populations, then:

$$\sum_{i=1}^k \sum_{j=1}^{n_i} (y_{ij} - \bar{y}_{\cdot\cdot})^2 = \sum_{i=1}^k n_i (\bar{y}_{i\cdot} - \bar{y}_{\cdot\cdot})^2 + \sum_{i=1}^k \sum_{j=1}^{n_i} (y_{ij} - \bar{y}_{i\cdot})^2$$

$$SS_{\text{total}} = SS_{\text{treatments}} + SS_{\text{error}}$$

If $N =$ total number observations

$$N = \sum_{i=1}^k n_i, \text{ then}$$

$$SS_{\text{total}} = \sum_{i=1}^k \sum_{j=1}^{n_i} y_{ij}^2 - \frac{y_{\cdot\cdot}^2}{N}$$

$$SS_{\text{treatments}} = \sum_{i=1}^k \frac{y_{i\cdot}^2}{n_i} - \frac{y_{\cdot\cdot}^2}{N}$$

$$SS_{\text{error}} = SS_{\text{total}} - SS_{\text{treatments}}$$

Montgomery, Douglas C., and George C. Runger, *Applied Statistics and Probability for Engineers*, 4 ed., New York: John Wiley and Sons, 2007.

Randomized Complete Block Design

For k treatments and b blocks

$$\sum_{i=1}^k \sum_{j=1}^b (y_{ij} - \bar{y}_{\cdot\cdot})^2 = b \sum_{i=1}^k (\bar{y}_{i\cdot} - \bar{y}_{\cdot\cdot})^2 + k \sum_{j=1}^b (\bar{y}_{\cdot j} - \bar{y}_{\cdot\cdot})^2 + \sum_{i=1}^k \sum_{j=1}^b (\bar{y}_{ij} - \bar{y}_{\cdot j} - \bar{y}_{i\cdot} + \bar{y}_{\cdot\cdot})^2$$

$$SS_{\text{total}} = SS_{\text{treatments}} + SS_{\text{blocks}} + SS_{\text{error}}$$

$$SS_{\text{total}} = \sum_{i=1}^k \sum_{j=1}^b y_{ij}^2 - \frac{y_{\cdot\cdot}^2}{kb}$$

$$SS_{\text{treatments}} = \frac{1}{b} \sum_{i=1}^k y_{i\cdot}^2 - \frac{y_{\cdot\cdot}^2}{bk}$$

$$SS_{\text{blocks}} = \frac{1}{k} \sum_{j=1}^b y_{\cdot j}^2 - \frac{y_{\cdot\cdot}^2}{bk}$$

$$SS_{\text{error}} = SS_{\text{total}} - SS_{\text{treatments}} - SS_{\text{blocks}}$$

Montgomery, Douglas C., and George C. Runger, *Applied Statistics and Probability for Engineers*, 4 ed., New York: John Wiley and Sons, 2007.

Two-factor Factorial Designs

For a levels of Factor A, b levels of Factor B, and n repetitions per cell:

$$\sum_{i=1}^a \sum_{j=1}^b \sum_{k=1}^n (y_{ijk} - \bar{y}_{...})^2 = bn \sum_{i=1}^a (\bar{y}_{i..} - \bar{y}_{...})^2 + an \sum_{j=1}^b (\bar{y}_{.j.} - \bar{y}_{...})^2 + n \sum_{i=1}^a \sum_{j=1}^b (\bar{y}_{ij.} - \bar{y}_{i..} - \bar{y}_{.j.} + \bar{y}_{...})^2 + \sum_{i=1}^a \sum_{j=1}^b \sum_{k=1}^n (y_{ijk} - \bar{y}_{ij.})^2$$

$$SS_{\text{total}} = SS_A + SS_B + SS_{AB} + SS_{\text{error}}$$

$$SS_{\text{total}} = \sum_{i=1}^a \sum_{j=1}^b \sum_{k=1}^n y_{ijk}^2 - \frac{y_{...}^2}{abn}$$

$$SS_A = \sum_{i=1}^a \frac{y_{i..}^2}{bn} - \frac{y_{...}^2}{abn}$$

$$SS_B = \sum_{j=1}^b \frac{y_{.j.}^2}{an} - \frac{y_{...}^2}{abn}$$

$$SS_{AB} = \sum_{i=1}^a \sum_{j=1}^b \frac{y_{ij.}^2}{n} - \frac{y_{...}^2}{abn} - SS_A - SS_B$$

$$SS_{\text{error}} = SS_T - SS_A - SS_B - SS_{AB}$$

Montgomery, Douglas C., and George C. Runger, *Applied Statistics and Probability for Engineers*, 4 ed., New York: John Wiley and Sons, 2007.

One-Way ANOVA Table

Source of Variation	Degrees of Freedom	Sum of Squares	Mean Square	F
Between Treatments	$k - 1$	$SS_{\text{treatments}}$	$MST = \frac{SS_{\text{treatments}}}{k - 1}$	$\frac{MST}{MSE}$
Error	$N - k$	SS_{error}	$MSE = \frac{SS_{\text{error}}}{N - k}$	
Total	$N - 1$	SS_{total}		

Randomized Complete Block ANOVA Table

Source of Variation	Degrees of Freedom	Sum of Squares	Mean Square	F
Between Treatments	$k - 1$	$SS_{\text{treatments}}$	$MST = \frac{SS_{\text{treatments}}}{k - 1}$	$\frac{MST}{MSE}$
Between Blocks	$n - 1$	SS_{blocks}	$MSB = \frac{SS_{\text{blocks}}}{n - 1}$	$\frac{MSB}{MSE}$
Error	$(k - 1)(n - 1)$	SS_{error}	$MSE = \frac{SS_{\text{error}}}{(k - 1)(n - 1)}$	
Total	$N - 1$	SS_{total}		

Two-Way Factorial ANOVA Table

Source of Variation	Degrees of Freedom	Sum of Squares	Mean Square	<i>F</i>
A Treatments	$a - 1$	SS_A	$MSA = \frac{SS_A}{a - 1}$	$\frac{MSA}{MSE}$
B Treatments	$b - 1$	SS_B	$MSB = \frac{SS_B}{b - 1}$	$\frac{MSB}{MSE}$
AB Interaction	$(a - 1)(b - 1)$	SS_{AB}	$MSAB = \frac{SS_{AB}}{(a - 1)(b - 1)}$	$\frac{MSAB}{MSE}$
Error	$ab(n - 1)$	SS_{error}	$MSE = \frac{SS_E}{ab(n - 1)}$	
Total	$abn - 1$	SS_{total}		

Consider an unknown parameter θ of a statistical distribution. Let the null hypothesis be

$$H_0: \mu = \mu_0$$

and let the alternative hypothesis be

$$H_1: \mu \neq \mu_0$$

Rejecting H_0 when it is true is known as a type I error, while accepting H_0 when it is wrong is known as a type II error. Furthermore, the probabilities of type I and type II errors are usually represented by the symbols α and β , respectively:

$$\alpha = \text{probability (type I error)}$$

$$\beta = \text{probability (type II error)}$$

The probability of a type I error is known as the level of significance of the test.

Table A. Tests on Means of Normal Distribution—Variance Known

<i>Hypothesis</i>	<i>Test Statistic</i>	<i>Criteria for Rejection</i>
$H_0: \mu = \mu_0$ $H_1: \mu \neq \mu_0$		$ Z_0 > Z_{\alpha/2}$
$H_0: \mu = \mu_0$ $H_1: \mu < \mu_0$	$Z_0 \equiv \frac{\bar{X} - \mu_0}{\sigma/\sqrt{n}}$	$Z_0 < -Z_{\alpha}$
$H_0: \mu = \mu_0$ $H_1: \mu > \mu_0$		$Z_0 > Z_{\alpha}$
$H_0: \mu_1 - \mu_2 = \gamma$ $H_1: \mu_1 - \mu_2 \neq \gamma$		$ Z_0 > Z_{\alpha/2}$
$H_0: \mu_1 - \mu_2 = \gamma$ $H_1: \mu_1 - \mu_2 < \gamma$	$Z_0 \equiv \frac{\bar{X}_1 - \bar{X}_2 - \gamma}{\sqrt{\frac{\sigma_1^2}{n_1} + \frac{\sigma_2^2}{n_2}}}$	$Z_0 < -Z_{\alpha}$
$H_0: \mu_1 - \mu_2 = \gamma$ $H_1: \mu_1 - \mu_2 > \gamma$		$Z_0 > Z_{\alpha}$

Table B. Tests on Means of Normal Distribution—Variance Unknown

<i>Hypothesis</i>	<i>Test Statistic</i>	<i>Criteria for Rejection</i>
$H_0: \mu = \mu_0$ $H_1: \mu \neq \mu_0$		$ t_0 > t_{\alpha/2, n-1}$
$H_0: \mu = \mu_0$ $H_1: \mu < \mu_0$	$t_0 = \frac{\bar{X} - \mu_0}{s/\sqrt{n}}$	$t_0 < -t_{\alpha, n-1}$
$H_0: \mu = \mu_0$ $H_1: \mu > \mu_0$		$t_0 > t_{\alpha, n-1}$
$H_0: \mu_1 - \mu_2 = \gamma$ $H_1: \mu_1 - \mu_2 \neq \gamma$	$t_0 = \frac{\bar{X}_1 - \bar{X}_2 - \gamma}{s_p \sqrt{\frac{1}{n_1} + \frac{1}{n_2}}}$ Variances equal $v = n_1 + n_2 - 2$	$ t_0 > t_{\alpha/2, v}$
$H_0: \mu_1 - \mu_2 = \gamma$ $H_1: \mu_1 - \mu_2 < \gamma$	$t_0 = \frac{\bar{X}_1 - \bar{X}_2 - \gamma}{\sqrt{\frac{s_1^2}{n_1} + \frac{s_2^2}{n_2}}}$ Variances unequal	$t_0 < -t_{\alpha, v}$
$H_0: \mu_1 - \mu_2 = \gamma$ $H_1: \mu_1 - \mu_2 > \gamma$	$v = \frac{\left(\frac{s_1^2}{n_1} + \frac{s_2^2}{n_2}\right)^2}{\frac{(s_1^2/n_1)^2}{n_1 - 1} + \frac{(s_2^2/n_2)^2}{n_2 - 1}}$	$t_0 > t_{\alpha, v}$

In Table B, $s_p^2 = [(n_1 - 1)s_1^2 + (n_2 - 1)s_2^2]/v$

Table C. Tests on Variances of Normal Distribution with Unknown Mean

Hypothesis	Test Statistic	Criteria for Rejection
$H_0: \sigma^2 = \sigma_0^2$ $H_1: \sigma^2 \neq \sigma_0^2$	$\chi_0^2 = \frac{(n-1)s^2}{\sigma_0^2}$	$\chi_0^2 > \chi_{\alpha/2, n-1}^2$ or $\chi_0^2 < \chi_{1-\alpha/2, n-1}^2$
$H_0: \sigma^2 = \sigma_0^2$ $H_1: \sigma^2 < \sigma_0^2$		$\chi_0^2 < \chi_{1-\alpha, n-1}^2$
$H_0: \sigma^2 = \sigma_0^2$ $H_1: \sigma^2 > \sigma_0^2$		$\chi_0^2 > \chi_{\alpha, n-1}^2$
<hr/>		
$H_0: \sigma_1^2 = \sigma_2^2$ $H_1: \sigma_1^2 \neq \sigma_2^2$	$F_0 = \frac{s_1^2}{s_2^2}$	$F_0 > F_{\alpha/2, n_1-1, n_2-1}$ $F_0 < F_{1-\alpha/2, n_1-1, n_2-1}$
$H_0: \sigma_1^2 = \sigma_2^2$ $H_1: \sigma_1^2 < \sigma_2^2$	$F_0 = \frac{s_2^2}{s_1^2}$	$F_0 > F_{\alpha, n_2-1, n_1-1}$
$H_0: \sigma_1^2 = \sigma_2^2$ $H_1: \sigma_1^2 > \sigma_2^2$	$F_0 = \frac{s_1^2}{s_2^2}$	$F_0 > F_{\alpha, n_1-1, n_2-1}$

Assume that the values of α and β are given. The sample size can be obtained from the following relationships. In (A) and (B), μ_1 is the value assumed to be the true mean.

(A) $H_0: \mu = \mu_0; H_1: \mu \neq \mu_0$

$$\beta = \Phi\left(\frac{\mu_0 - \mu}{\sigma/\sqrt{n}} + Z_{\alpha/2}\right) - \Phi\left(\frac{\mu_0 - \mu}{\sigma/\sqrt{n}} - Z_{\alpha/2}\right)$$

An approximate result is

$$n \simeq \frac{(Z_{\alpha/2} + Z_{\beta})^2 \sigma^2}{(\mu_1 - \mu_0)^2}$$

(B) $H_0: \mu = \mu_0; H_1: \mu > \mu_0$

$$\beta = \Phi\left(\frac{\mu_0 - \mu}{\sigma/\sqrt{n}} + Z_{\alpha}\right)$$

$$n = \frac{(Z_{\alpha} + Z_{\beta})^2 \sigma^2}{(\mu_1 - \mu_0)^2}$$

Confidence Intervals, Sample Distributions and Sample Size

Confidence Interval for the Mean μ of a Normal Distribution

(A) Standard deviation σ is known

$$\bar{X} - Z_{\alpha/2} \frac{\sigma}{\sqrt{n}} \leq \mu \leq \bar{X} + Z_{\alpha/2} \frac{\sigma}{\sqrt{n}}$$

(B) Standard deviation σ is not known

$$\bar{X} - t_{\alpha/2} \frac{s}{\sqrt{n}} \leq \mu \leq \bar{X} + t_{\alpha/2} \frac{s}{\sqrt{n}}$$

where $t_{\alpha/2}$ corresponds to $n - 1$ degrees of freedom.

Confidence Interval for the Difference Between Two Means μ_1 and μ_2

(A) Standard deviations σ_1 and σ_2 known

$$\bar{X}_1 - \bar{X}_2 - Z_{\alpha/2} \sqrt{\frac{\sigma_1^2}{n_1} + \frac{\sigma_2^2}{n_2}} \leq \mu_1 - \mu_2 \leq \bar{X}_1 - \bar{X}_2 + Z_{\alpha/2} \sqrt{\frac{\sigma_1^2}{n_1} + \frac{\sigma_2^2}{n_2}}$$

(B) Standard deviations σ_1 and σ_2 are not known

$$\bar{X}_1 - \bar{X}_2 - t_{\alpha/2} \sqrt{\frac{\left(\frac{1}{n_1} + \frac{1}{n_2}\right) \left[(n_1 - 1)s_1^2 + (n_2 - 1)s_2^2 \right]}{n_1 + n_2 - 2}} \leq \mu_1 - \mu_2 \leq \bar{X}_1 - \bar{X}_2 + t_{\alpha/2} \sqrt{\frac{\left(\frac{1}{n_1} + \frac{1}{n_2}\right) \left[(n_1 - 1)s_1^2 + (n_2 - 1)s_2^2 \right]}{n_1 + n_2 - 2}}$$

where $t_{\alpha/2}$ corresponds to $n_1 + n_2 - 2$ degrees of freedom.

Confidence Intervals for the Variance σ^2 of a Normal Distribution

$$\frac{(n-1)s^2}{\chi_{\alpha/2, n-1}^2} \leq \sigma^2 \leq \frac{(n-1)s^2}{\chi_{1-\alpha/2, n-1}^2}$$

Sample Size

$$z = \frac{\bar{X} - \mu}{\sigma/\sqrt{n}} \quad n = \left[\frac{z_{\alpha/2} \sigma}{\bar{x} - \mu} \right]^2$$

Test Statistics

The following definitions apply.

$$Z_{\text{var}} = \frac{\bar{X} - \mu_0}{\frac{\sigma}{\sqrt{n}}}$$

$$t_{\text{var}} = \frac{\bar{X} - \mu_0}{\frac{s}{\sqrt{n}}}$$

where

Z_{var} = standard normal Z score

t_{var} = sample distribution test statistic

σ = standard deviation

μ_0 = population mean

\bar{X} = hypothesized mean or sample mean

n = sample size

s = computed sample standard deviation

The Z score is applicable when the standard deviation (s) is known. The test statistic is applicable when the standard deviation (s) is computed at time of sampling.

Z_{α} corresponds to the appropriate probability under the normal probability curve for a given Z_{var} .

$t_{\alpha, n-1}$ corresponds to the appropriate probability under the t distribution with $n-1$ degrees of freedom for a given t_{var} .

Values of $Z_{\alpha/2}$

Confidence Interval	$Z_{\alpha/2}$
80%	1.2816
90%	1.6449
95%	1.9600
96%	2.0537
98%	2.3263
99%	2.5758

Unit Normal Distribution ($\mu = 0, \sigma = 1$)

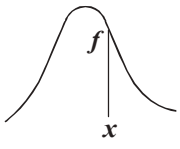
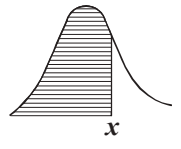
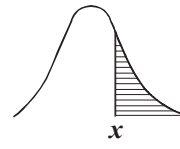
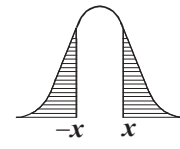
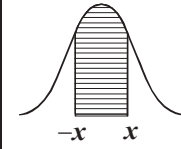
					
x	$f(x)$	$F(x)$	$R(x)$	$2R(x)$	$W(x)$
0.0	0.3989	0.5000	0.5000	1.0000	0.0000
0.1	0.3970	0.5398	0.4602	0.9203	0.0797
0.2	0.3910	0.5793	0.4207	0.8415	0.1585
0.3	0.3814	0.6179	0.3821	0.7642	0.2358
0.4	0.3683	0.6554	0.3446	0.6892	0.3108
0.5	0.3521	0.6915	0.3085	0.6171	0.3829
0.6	0.3332	0.7257	0.2743	0.5485	0.4515
0.7	0.3123	0.7580	0.2420	0.4839	0.5161
0.8	0.2897	0.7881	0.2119	0.4237	0.5763
0.9	0.2661	0.8159	0.1841	0.3681	0.6319
1.0	0.2420	0.8413	0.1587	0.3173	0.6827
1.1	0.2179	0.8643	0.1357	0.2713	0.7287
1.2	0.1942	0.8849	0.1151	0.2301	0.7699
1.3	0.1714	0.9032	0.0968	0.1936	0.8064
1.4	0.1497	0.9192	0.0808	0.1615	0.8385
1.5	0.1295	0.9332	0.0668	0.1336	0.8664
1.6	0.1109	0.9452	0.0548	0.1096	0.8904
1.7	0.0940	0.9554	0.0446	0.0891	0.9109
1.8	0.0790	0.9641	0.0359	0.0719	0.9281
1.9	0.0656	0.9713	0.0287	0.0574	0.9426
2.0	0.0540	0.9772	0.0228	0.0455	0.9545
2.1	0.0440	0.9821	0.0179	0.0357	0.9643
2.2	0.0355	0.9861	0.0139	0.0278	0.9722
2.3	0.0283	0.9893	0.0107	0.0214	0.9786
2.4	0.0224	0.9918	0.0082	0.0164	0.9836
2.5	0.0175	0.9938	0.0062	0.0124	0.9876
2.6	0.0136	0.9953	0.0047	0.0093	0.9907
2.7	0.0104	0.9965	0.0035	0.0069	0.9931
2.8	0.0079	0.9974	0.0026	0.0051	0.9949
2.9	0.0060	0.9981	0.0019	0.0037	0.9963
3.0	0.0044	0.9987	0.0013	0.0027	0.9973
Fractiles					
1.2816	0.1755	0.9000	0.1000	0.2000	0.8000
1.6449	0.1031	0.9500	0.0500	0.1000	0.9000
1.9600	0.0584	0.9750	0.0250	0.0500	0.9500
2.0537	0.0484	0.9800	0.0200	0.0400	0.9600
2.3263	0.0267	0.9900	0.0100	0.0200	0.9800
2.5758	0.0145	0.9950	0.0050	0.0100	0.9900

Student's *t*-Distribution

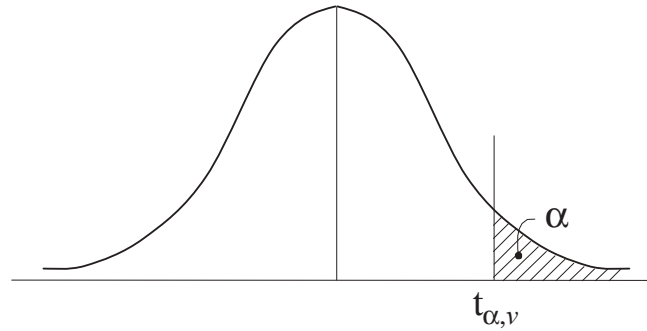

VALUES OF $t_{\alpha,v}$

<i>v</i>	α								<i>v</i>
	0.25	0.20	0.15	0.10	0.05	0.025	0.01	0.005	
1	1.000	1.376	1.963	3.078	6.314	12.706	31.821	63.657	1
2	0.816	1.061	1.386	1.886	2.920	4.303	6.965	9.925	2
3	0.765	0.978	1.350	1.638	2.353	3.182	4.541	5.841	3
4	0.741	0.941	1.190	1.533	2.132	2.776	3.747	4.604	4
5	0.727	0.920	1.156	1.476	2.015	2.571	3.365	4.032	5
6	0.718	0.906	1.134	1.440	1.943	2.447	3.143	3.707	6
7	0.711	0.896	1.119	1.415	1.895	2.365	2.998	3.499	7
8	0.706	0.889	1.108	1.397	1.860	2.306	2.896	3.355	8
9	0.703	0.883	1.100	1.383	1.833	2.262	2.821	3.250	9
10	0.700	0.879	1.093	1.372	1.812	2.228	2.764	3.169	10
11	0.697	0.876	1.088	1.363	1.796	2.201	2.718	3.106	11
12	0.695	0.873	1.083	1.356	1.782	2.179	2.681	3.055	12
13	0.694	0.870	1.079	1.350	1.771	2.160	2.650	3.012	13
14	0.692	0.868	1.076	1.345	1.761	2.145	2.624	2.977	14
15	0.691	0.866	1.074	1.341	1.753	2.131	2.602	2.947	15
16	0.690	0.865	1.071	1.337	1.746	2.120	2.583	2.921	16
17	0.689	0.863	1.069	1.333	1.740	2.110	2.567	2.898	17
18	0.688	0.862	1.067	1.330	1.734	2.101	2.552	2.878	18
19	0.688	0.861	1.066	1.328	1.729	2.093	2.539	2.861	19
20	0.687	0.860	1.064	1.325	1.725	2.086	2.528	2.845	20
21	0.686	0.859	1.063	1.323	1.721	2.080	2.518	2.831	21
22	0.686	0.858	1.061	1.321	1.717	2.074	2.508	2.819	22
23	0.685	0.858	1.060	1.319	1.714	2.069	2.500	2.807	23
24	0.685	0.857	1.059	1.318	1.711	2.064	2.492	2.797	24
25	0.684	0.856	1.058	1.316	1.708	2.060	2.485	2.787	25
26	0.684	0.856	1.058	1.315	1.706	2.056	2.479	2.779	26
27	0.684	0.855	1.057	1.314	1.703	2.052	2.473	2.771	27
28	0.683	0.855	1.056	1.313	1.701	2.048	2.467	2.763	28
29	0.683	0.854	1.055	1.311	1.699	2.045	2.462	2.756	29
30	0.683	0.854	1.055	1.310	1.697	2.042	2.457	2.750	30
∞	0.674	0.842	1.036	1.282	1.645	1.960	2.326	2.576	∞

CRITICAL VALUES OF THE F DISTRIBUTION – TABLE

For a particular combination of numerator and denominator degrees of freedom, entry represents the critical values of F corresponding to a specified upper tail area (α).

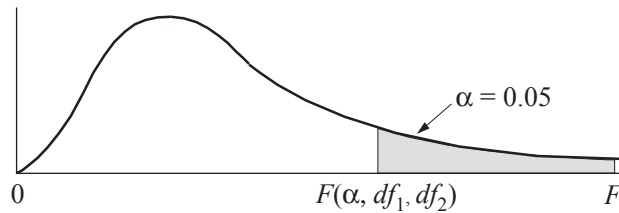

Denominator df_2	Numerator df_1																		
	1	2	3	4	5	6	7	8	9	10	12	15	20	24	30	40	60	120	∞
1	161.4	199.5	215.7	224.6	230.2	234.0	236.8	238.9	240.5	241.9	243.9	245.9	248.0	249.1	250.1	251.1	252.2	253.3	254.3
2	18.51	19.00	19.16	19.25	19.30	19.33	19.35	19.37	19.38	19.40	19.41	19.43	19.45	19.45	19.46	19.47	19.48	19.49	19.50
3	10.13	9.55	9.28	9.12	9.01	8.94	8.89	8.85	8.81	8.79	8.74	8.70	8.66	8.64	8.62	8.59	8.57	8.55	8.53
4	7.71	6.94	6.59	6.39	6.26	6.16	6.09	6.04	6.00	5.96	5.91	5.86	5.80	5.77	5.72	5.69	5.66	5.64	5.63
5	6.61	5.79	5.41	5.19	5.05	4.95	4.88	4.82	4.77	4.74	4.68	4.62	4.56	4.53	4.50	4.46	4.43	4.40	4.36
6	5.99	5.14	4.76	4.53	4.39	4.28	4.21	4.15	4.10	4.06	4.00	3.94	3.87	3.84	3.81	3.77	3.74	3.70	3.67
7	5.59	4.74	4.35	4.12	3.97	3.87	3.79	3.73	3.68	3.64	3.57	3.51	3.44	3.41	3.38	3.34	3.30	3.27	3.23
8	5.32	4.46	4.07	3.84	3.69	3.58	3.50	3.44	3.39	3.35	3.28	3.22	3.15	3.12	3.08	3.04	3.01	2.97	2.93
9	5.12	4.26	3.86	3.63	3.48	3.37	3.29	3.23	3.18	3.14	3.07	3.01	2.94	2.90	2.86	2.83	2.79	2.75	2.71
10	4.96	4.10	3.71	3.48	3.33	3.22	3.14	3.07	3.02	2.98	2.91	2.85	2.77	2.74	2.70	2.66	2.62	2.58	2.54
11	4.84	3.98	3.59	3.36	3.20	3.09	3.01	2.95	2.90	2.85	2.79	2.72	2.65	2.61	2.57	2.53	2.49	2.45	2.40
12	4.75	3.89	3.49	3.26	3.11	3.00	2.91	2.85	2.80	2.75	2.69	2.62	2.54	2.51	2.47	2.43	2.38	2.34	2.30
13	4.67	3.81	3.41	3.18	3.03	2.92	2.83	2.77	2.71	2.67	2.60	2.53	2.46	2.42	2.38	2.34	2.30	2.25	2.21
14	4.60	3.74	3.34	3.11	2.96	2.85	2.76	2.70	2.65	2.60	2.53	2.46	2.39	2.35	2.31	2.27	2.22	2.18	2.13
15	4.54	3.68	3.29	3.06	2.90	2.79	2.71	2.64	2.59	2.54	2.48	2.40	2.33	2.29	2.25	2.20	2.16	2.11	2.07
16	4.49	3.63	3.24	3.01	2.85	2.74	2.66	2.59	2.54	2.49	2.42	2.35	2.28	2.24	2.19	2.15	2.11	2.06	2.01
17	4.45	3.59	3.20	2.96	2.81	2.70	2.61	2.55	2.49	2.45	2.38	2.31	2.23	2.19	2.15	2.10	2.06	2.01	1.96
18	4.41	3.55	3.16	2.93	2.77	2.66	2.58	2.51	2.46	2.41	2.34	2.27	2.19	2.15	2.11	2.06	2.02	1.97	1.92
19	4.38	3.52	3.13	2.90	2.74	2.63	2.54	2.48	2.42	2.38	2.31	2.23	2.16	2.11	2.07	2.03	1.98	1.93	1.88
20	4.35	3.49	3.10	2.87	2.71	2.60	2.51	2.45	2.39	2.35	2.28	2.20	2.12	2.08	2.04	1.99	1.95	1.90	1.84
21	4.32	3.47	3.07	2.84	2.68	2.57	2.49	2.42	2.37	2.32	2.25	2.18	2.10	2.05	2.01	1.96	1.92	1.87	1.81
22	4.30	3.44	3.05	2.82	2.66	2.55	2.46	2.40	2.34	2.30	2.23	2.15	2.07	2.03	1.98	1.94	1.89	1.84	1.78
23	4.28	3.42	3.03	2.80	2.64	2.53	2.44	2.37	2.32	2.27	2.20	2.13	2.05	2.01	1.96	1.91	1.86	1.81	1.76
24	4.26	3.40	3.01	2.78	2.62	2.51	2.42	2.36	2.30	2.25	2.18	2.11	2.03	1.98	1.94	1.89	1.84	1.79	1.73
25	4.24	3.39	2.99	2.76	2.60	2.49	2.40	2.34	2.28	2.24	2.16	2.09	2.01	1.96	1.92	1.87	1.82	1.77	1.71
26	4.23	3.37	2.98	2.74	2.59	2.47	2.39	2.32	2.27	2.22	2.15	2.07	1.99	1.95	1.90	1.85	1.80	1.75	1.69
27	4.21	3.35	2.96	2.73	2.57	2.46	2.37	2.31	2.25	2.20	2.13	2.06	1.97	1.93	1.88	1.84	1.79	1.73	1.67
28	4.20	3.34	2.95	2.71	2.56	2.45	2.36	2.29	2.24	2.19	2.12	2.04	1.96	1.91	1.87	1.82	1.77	1.71	1.65
29	4.18	3.33	2.93	2.70	2.55	2.43	2.35	2.28	2.22	2.18	2.10	2.03	1.94	1.90	1.85	1.81	1.75	1.70	1.64
30	4.17	3.32	2.92	2.69	2.53	2.42	2.33	2.27	2.21	2.16	2.09	2.01	1.93	1.89	1.84	1.79	1.74	1.68	1.62
40	4.08	3.23	2.84	2.61	2.45	2.34	2.25	2.18	2.12	2.08	2.00	1.92	1.84	1.79	1.74	1.69	1.64	1.58	1.51
60	4.00	3.15	2.76	2.53	2.37	2.25	2.17	2.10	2.04	1.99	1.92	1.84	1.75	1.70	1.65	1.59	1.53	1.47	1.39
120	3.92	3.07	2.68	2.45	2.29	2.17	2.09	2.02	1.96	1.91	1.83	1.75	1.66	1.61	1.55	1.50	1.43	1.35	1.25
∞	3.84	3.00	2.60	2.37	2.21	2.10	2.01	1.94	1.88	1.83	1.75	1.67	1.57	1.52	1.46	1.39	1.32	1.22	1.00

CRITICAL VALUES OF χ^2 DISTRIBUTION

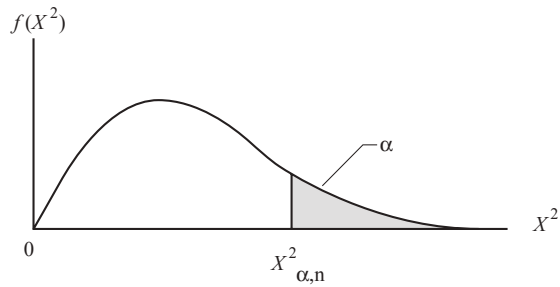

Degrees of Freedom	$\chi^2_{.995}$	$\chi^2_{.990}$	$\chi^2_{.975}$	$\chi^2_{.950}$	$\chi^2_{.900}$	$\chi^2_{.100}$	$\chi^2_{.050}$	$\chi^2_{.025}$	$\chi^2_{.010}$	$\chi^2_{.005}$
1	0.0000393	0.0001571	0.0009821	0.0039321	0.0157908	2.70554	3.84146	5.02389	6.63490	7.87944
2	0.0100251	0.0201007	0.0506356	0.102587	0.210720	4.60517	5.99147	7.37776	9.21034	10.5966
3	0.0717212	0.114832	0.215795	0.351846	0.584375	6.25139	7.81473	9.34840	11.3449	12.8381
4	0.206990	0.297110	0.484419	0.710721	1.063623	7.77944	9.48773	11.1433	13.2767	14.8602
5	0.411740	0.554300	0.831211	1.145476	1.61031	9.23635	11.0705	12.8325	15.0863	16.7496
6	0.675727	0.872085	1.237347	1.63539	2.20413	10.6446	12.5916	14.4494	16.8119	18.5476
7	0.989265	1.239043	1.68987	2.16735	2.83311	12.0170	14.0671	16.0128	18.4753	20.2777
8	1.344419	1.646482	2.17973	2.73264	3.48954	13.3616	15.5073	17.5346	20.0902	21.9550
9	1.734926	2.087912	2.70039	3.32511	4.16816	14.6837	16.9190	19.0228	21.6660	23.5893
10	2.15585	2.55821	3.24697	3.94030	4.86518	15.9871	18.3070	20.4831	23.2093	25.1882
11	2.60321	3.05347	3.81575	4.57481	5.57779	17.2750	19.6751	21.9200	24.7250	26.7569
12	3.07382	3.57056	4.40379	5.22603	6.30380	18.5494	21.0261	23.3367	26.2170	28.2995
13	3.56503	4.10691	5.00874	5.89186	7.04150	19.8119	22.3621	24.7356	27.6883	29.8194
14	4.07468	4.66043	5.62872	6.57063	7.78953	21.0642	23.6848	26.1190	29.1413	31.3193
15	4.60094	5.22935	6.26214	7.26094	8.54675	22.3072	24.9958	27.4884	30.5779	32.8013
16	5.14224	5.81221	6.90766	7.96164	9.31223	23.5418	26.2962	28.8454	31.9999	34.2672
17	5.69724	6.40776	7.56418	8.67176	10.0852	24.7690	27.5871	30.1910	33.4087	35.7185
18	6.26481	7.01491	8.23075	9.39046	10.8649	25.9894	28.8693	31.5264	34.8053	37.1564
19	6.84398	7.63273	8.90655	10.1170	11.6509	27.2036	30.1435	32.8523	36.1908	38.5822
20	7.43386	8.26040	9.59083	10.8508	12.4426	28.4120	31.4104	34.1696	37.5662	39.9968
21	8.03366	8.89720	10.28293	11.5913	13.2396	29.6151	32.6705	35.4789	38.9321	41.4010
22	8.64272	9.54249	10.9823	12.3380	14.0415	30.8133	33.9244	36.7807	40.2894	42.7956
23	9.26042	10.19567	11.6885	13.0905	14.8479	32.0069	35.1725	38.0757	41.6384	44.1813
24	9.88623	10.8564	12.4011	13.8484	15.6587	33.1963	36.4151	39.3641	42.9798	45.5585
25	10.5197	11.5240	13.1197	14.6114	16.4734	34.3816	37.6525	40.6465	44.3141	46.9278
26	11.1603	12.1981	13.8439	15.3791	17.2919	35.5631	38.8852	41.9232	45.6417	48.2899
27	11.8076	12.8786	14.5733	16.1513	18.1138	36.7412	40.1133	43.1944	46.9630	49.6449
28	12.4613	13.5648	15.3079	16.9279	18.9392	37.9159	41.3372	44.4607	48.2782	50.9933
29	13.1211	14.2565	16.0471	17.7083	19.7677	39.0875	42.5569	45.7222	49.5879	52.3356
30	13.7867	14.9535	16.7908	18.4926	20.5992	40.2560	43.7729	46.9792	50.8922	53.6720
40	20.7065	22.1643	24.4331	26.5093	29.0505	51.8050	55.7585	59.3417	63.6907	66.7659
50	27.9907	29.7067	32.3574	34.7642	37.6886	63.1671	67.5048	71.4202	76.1539	79.4900
60	35.5346	37.4848	40.4817	43.1879	46.4589	74.3970	79.0819	83.2976	88.3794	91.9517
70	43.2752	45.4418	48.7576	51.7393	55.3290	85.5271	90.5312	95.0231	100.425	104.215
80	51.1720	53.5400	57.1532	60.3915	64.2778	96.5782	101.879	106.629	112.329	116.321
90	59.1963	61.7541	65.6466	69.1260	73.2912	107.565	113.145	118.136	124.116	128.299
100	67.3276	70.0648	74.2219	77.9295	82.3581	118.498	124.342	129.561	135.807	140.169

Source: Thompson, C. M., "Tables of the Percentage Points of the χ^2 -Distribution," *Biometrika*, ©1941, 32, 188-189. Reproduced by permission of Oxford University Press.

Cumulative Binomial Probabilities $P(X \leq x)$

		P										
n	x	0.1	0.2	0.3	0.4	0.5	0.6	0.7	0.8	0.9	0.95	0.99
1	0	0.9000	0.8000	0.7000	0.6000	0.5000	0.4000	0.3000	0.2000	0.1000	0.0500	0.0100
2	0	0.8100	0.6400	0.4900	0.3600	0.2500	0.1600	0.0900	0.0400	0.0100	0.0025	0.0001
	1	0.9900	0.9600	0.9100	0.8400	0.7500	0.6400	0.5100	0.3600	0.1900	0.0975	0.0199
3	0	0.7290	0.5120	0.3430	0.2160	0.1250	0.0640	0.0270	0.0080	0.0010	0.0001	0.0000
	1	0.9720	0.8960	0.7840	0.6480	0.5000	0.3520	0.2160	0.1040	0.0280	0.0073	0.0003
	2	0.9990	0.9920	0.9730	0.9360	0.8750	0.7840	0.6570	0.4880	0.2710	0.1426	0.0297
4	0	0.6561	0.4096	0.2401	0.1296	0.0625	0.0256	0.0081	0.0016	0.0001	0.0000	0.0000
	1	0.9477	0.8192	0.6517	0.4752	0.3125	0.1792	0.0837	0.0272	0.0037	0.0005	0.0000
	2	0.9963	0.9728	0.9163	0.8208	0.6875	0.5248	0.3483	0.1808	0.0523	0.0140	0.0006
	3	0.9999	0.9984	0.9919	0.9744	0.9375	0.8704	0.7599	0.5904	0.3439	0.1855	0.0394
5	0	0.5905	0.3277	0.1681	0.0778	0.0313	0.0102	0.0024	0.0003	0.0000	0.0000	0.0000
	1	0.9185	0.7373	0.5282	0.3370	0.1875	0.0870	0.0308	0.0067	0.0005	0.0000	0.0000
	2	0.9914	0.9421	0.8369	0.6826	0.5000	0.3174	0.1631	0.0579	0.0086	0.0012	0.0000
	3	0.9995	0.9933	0.9692	0.9130	0.8125	0.6630	0.4718	0.2627	0.0815	0.0226	0.0010
	4	1.0000	0.9997	0.9976	0.9898	0.9688	0.9222	0.8319	0.6723	0.4095	0.2262	0.0490
6	0	0.5314	0.2621	0.1176	0.0467	0.0156	0.0041	0.0007	0.0001	0.0000	0.0000	0.0000
	1	0.8857	0.6554	0.4202	0.2333	0.1094	0.0410	0.0109	0.0016	0.0001	0.0000	0.0000
	2	0.9842	0.9011	0.7443	0.5443	0.3438	0.1792	0.0705	0.0170	0.0013	0.0001	0.0000
	3	0.9987	0.9830	0.9295	0.8208	0.6563	0.4557	0.2557	0.0989	0.0159	0.0022	0.0000
	4	0.9999	0.9984	0.9891	0.9590	0.8906	0.7667	0.5798	0.3446	0.1143	0.0328	0.0015
	5	1.0000	0.9999	0.9993	0.9959	0.9844	0.9533	0.8824	0.7379	0.4686	0.2649	0.0585
7	0	0.4783	0.2097	0.0824	0.0280	0.0078	0.0016	0.0002	0.0000	0.0000	0.0000	0.0000
	1	0.8503	0.5767	0.3294	0.1586	0.0625	0.0188	0.0038	0.0004	0.0000	0.0000	0.0000
	2	0.9743	0.8520	0.6471	0.4199	0.2266	0.0963	0.0288	0.0047	0.0002	0.0000	0.0000
	3	0.9973	0.9667	0.8740	0.7102	0.5000	0.2898	0.1260	0.0333	0.0027	0.0002	0.0000
	4	0.9998	0.9953	0.9712	0.9037	0.7734	0.5801	0.3529	0.1480	0.0257	0.0038	0.0000
	5	1.0000	0.9996	0.9962	0.9812	0.9375	0.8414	0.6706	0.4233	0.1497	0.0444	0.0020
	6	1.0000	1.0000	0.9998	0.9984	0.9922	0.9720	0.9176	0.7903	0.5217	0.3017	0.0679
8	0	0.4305	0.1678	0.0576	0.0168	0.0039	0.0007	0.0001	0.0000	0.0000	0.0000	0.0000
	1	0.8131	0.5033	0.2553	0.1064	0.0352	0.0085	0.0013	0.0001	0.0000	0.0000	0.0000
	2	0.9619	0.7969	0.5518	0.3154	0.1445	0.0498	0.0113	0.0012	0.0000	0.0000	0.0000
	3	0.9950	0.9437	0.8059	0.5941	0.3633	0.1737	0.0580	0.0104	0.0004	0.0000	0.0000
	4	0.9996	0.9896	0.9420	0.8263	0.6367	0.4059	0.1941	0.0563	0.0050	0.0004	0.0000
	5	1.0000	0.9988	0.9887	0.9502	0.8555	0.6846	0.4482	0.2031	0.0381	0.0058	0.0001
	6	1.0000	0.9999	0.9987	0.9915	0.9648	0.8936	0.7447	0.4967	0.1869	0.0572	0.0027
	7	1.0000	1.0000	0.9999	0.9993	0.9961	0.9832	0.9424	0.8322	0.5695	0.3366	0.0773
9	0	0.3874	0.1342	0.0404	0.0101	0.0020	0.0003	0.0000	0.0000	0.0000	0.0000	0.0000
	1	0.7748	0.4362	0.1960	0.0705	0.0195	0.0038	0.0004	0.0000	0.0000	0.0000	0.0000
	2	0.9470	0.7382	0.4628	0.2318	0.0898	0.0250	0.0043	0.0003	0.0000	0.0000	0.0000
	3	0.9917	0.9144	0.7297	0.4826	0.2539	0.0994	0.0253	0.0031	0.0001	0.0000	0.0000
	4	0.9991	0.9804	0.9012	0.7334	0.5000	0.2666	0.0988	0.0196	0.0009	0.0000	0.0000
	5	0.9999	0.9969	0.9747	0.9006	0.7461	0.5174	0.2703	0.0856	0.0083	0.0006	0.0000
	6	1.0000	0.9997	0.9957	0.9750	0.9102	0.7682	0.5372	0.2618	0.0530	0.0084	0.0001
	7	1.0000	1.0000	0.9996	0.9962	0.9805	0.9295	0.8040	0.5638	0.2252	0.0712	0.0034
	8	1.0000	1.0000	1.0000	0.9997	0.9980	0.9899	0.9596	0.8658	0.6126	0.3698	0.0865

Montgomery, Douglas C., and George C. Runger, *Applied Statistics and Probability for Engineers*, 4 ed., New York: John Wiley and Sons, 2007.

Cumulative Binomial Probabilities $P(X \leq x)$ (continued)

n	x	P											
		0.1	0.2	0.3	0.4	0.5	0.6	0.7	0.8	0.9	0.95	0.99	
10	0	0.3487	0.1074	0.0282	0.0060	0.0010	0.0001	0.0000	0.0000	0.0000	0.0000	0.0000	0.0000
	1	0.7361	0.3758	0.1493	0.0464	0.0107	0.0017	0.0001	0.0000	0.0000	0.0000	0.0000	0.0000
	2	0.9298	0.6778	0.3828	0.1673	0.0547	0.0123	0.0016	0.0001	0.0000	0.0000	0.0000	0.0000
	3	0.9872	0.8791	0.6496	0.3823	0.1719	0.0548	0.0106	0.0009	0.0000	0.0000	0.0000	0.0000
	4	0.9984	0.9672	0.8497	0.6331	0.3770	0.1662	0.0473	0.0064	0.0001	0.0000	0.0000	0.0000
	5	0.9999	0.9936	0.9527	0.8338	0.6230	0.3669	0.1503	0.0328	0.0016	0.0001	0.0000	0.0000
	6	1.0000	0.9991	0.9894	0.9452	0.8281	0.6177	0.3504	0.1209	0.0128	0.0010	0.0000	0.0000
	7	1.0000	0.9999	0.9984	0.9877	0.9453	0.8327	0.6172	0.3222	0.0702	0.0115	0.0001	0.0000
	8	1.0000	1.0000	0.9999	0.9983	0.9893	0.9536	0.8507	0.6242	0.2639	0.0861	0.0043	0.0000
	9	1.0000	1.0000	1.0000	0.9999	0.9990	0.9940	0.9718	0.8926	0.6513	0.4013	0.0956	0.0000
15	0	0.2059	0.0352	0.0047	0.0005	0.0000	0.0000	0.0000	0.0000	0.0000	0.0000	0.0000	0.0000
	1	0.5490	0.1671	0.0353	0.0052	0.0005	0.0000	0.0000	0.0000	0.0000	0.0000	0.0000	0.0000
	2	0.8159	0.3980	0.1268	0.0271	0.0037	0.0003	0.0000	0.0000	0.0000	0.0000	0.0000	0.0000
	3	0.9444	0.6482	0.2969	0.0905	0.0176	0.0019	0.0001	0.0000	0.0000	0.0000	0.0000	0.0000
	4	0.9873	0.8358	0.5155	0.2173	0.0592	0.0093	0.0007	0.0000	0.0000	0.0000	0.0000	0.0000
	5	0.9978	0.9389	0.7216	0.4032	0.1509	0.0338	0.0037	0.0001	0.0000	0.0000	0.0000	0.0000
	6	0.9997	0.9819	0.8689	0.6098	0.3036	0.0950	0.0152	0.0008	0.0000	0.0000	0.0000	0.0000
	7	1.0000	0.9958	0.9500	0.7869	0.5000	0.2131	0.0500	0.0042	0.0000	0.0000	0.0000	0.0000
	8	1.0000	0.9992	0.9848	0.9050	0.6964	0.3902	0.1311	0.0181	0.0003	0.0000	0.0000	0.0000
	9	1.0000	0.9999	0.9963	0.9662	0.8491	0.5968	0.2784	0.0611	0.0022	0.0001	0.0000	0.0000
	10	1.0000	1.0000	0.9993	0.9907	0.9408	0.7827	0.4845	0.1642	0.0127	0.0006	0.0000	0.0000
	11	1.0000	1.0000	0.9999	0.9981	0.9824	0.9095	0.7031	0.3518	0.0556	0.0055	0.0000	0.0000
	12	1.0000	1.0000	1.0000	0.9997	0.9963	0.9729	0.8732	0.6020	0.1841	0.0362	0.0004	0.0000
	13	1.0000	1.0000	1.0000	1.0000	0.9995	0.9948	0.9647	0.8329	0.4510	0.1710	0.0096	0.0000
	14	1.0000	1.0000	1.0000	1.0000	1.0000	0.9995	0.9953	0.9648	0.7941	0.5367	0.1399	0.0000
20	0	0.1216	0.0115	0.0008	0.0000	0.0000	0.0000	0.0000	0.0000	0.0000	0.0000	0.0000	0.0000
	1	0.3917	0.0692	0.0076	0.0005	0.0000	0.0000	0.0000	0.0000	0.0000	0.0000	0.0000	0.0000
	2	0.6769	0.2061	0.0355	0.0036	0.0002	0.0000	0.0000	0.0000	0.0000	0.0000	0.0000	0.0000
	3	0.8670	0.4114	0.1071	0.0160	0.0013	0.0000	0.0000	0.0000	0.0000	0.0000	0.0000	0.0000
	4	0.9568	0.6296	0.2375	0.0510	0.0059	0.0003	0.0000	0.0000	0.0000	0.0000	0.0000	0.0000
	5	0.9887	0.8042	0.4164	0.1256	0.0207	0.0016	0.0000	0.0000	0.0000	0.0000	0.0000	0.0000
	6	0.9976	0.9133	0.6080	0.2500	0.0577	0.0065	0.0003	0.0000	0.0000	0.0000	0.0000	0.0000
	7	0.9996	0.9679	0.7723	0.4159	0.1316	0.0210	0.0013	0.0000	0.0000	0.0000	0.0000	0.0000
	8	0.9999	0.9900	0.8867	0.5956	0.2517	0.0565	0.0051	0.0001	0.0000	0.0000	0.0000	0.0000
	9	1.0000	0.9974	0.9520	0.7553	0.4119	0.1275	0.0171	0.0006	0.0000	0.0000	0.0000	0.0000
	10	1.0000	0.9994	0.9829	0.8725	0.5881	0.2447	0.0480	0.0026	0.0000	0.0000	0.0000	0.0000
	11	1.0000	0.9999	0.9949	0.9435	0.7483	0.4044	0.1133	0.0100	0.0001	0.0000	0.0000	0.0000
	12	1.0000	1.0000	0.9987	0.9790	0.8684	0.5841	0.2277	0.0321	0.0004	0.0000	0.0000	0.0000
	13	1.0000	1.0000	0.9997	0.9935	0.9423	0.7500	0.3920	0.0867	0.0024	0.0000	0.0000	0.0000
	14	1.0000	1.0000	1.0000	0.9984	0.9793	0.8744	0.5836	0.1958	0.0113	0.0003	0.0000	0.0000
	15	1.0000	1.0000	1.0000	0.9997	0.9941	0.9490	0.7625	0.3704	0.0432	0.0026	0.0000	0.0000
	16	1.0000	1.0000	1.0000	1.0000	0.9987	0.9840	0.8929	0.5886	0.1330	0.0159	0.0000	0.0000
	17	1.0000	1.0000	1.0000	1.0000	0.9998	0.9964	0.9645	0.7939	0.3231	0.0755	0.0010	0.0000
	18	1.0000	1.0000	1.0000	1.0000	1.0000	0.9995	0.9924	0.9308	0.6083	0.2642	0.0169	0.0000
	19	1.0000	1.0000	1.0000	1.0000	1.0000	1.0000	0.9992	0.9885	0.8784	0.6415	0.1821	0.0000

Statistical Quality Control

Average and Range Charts

n	A_2	D_3	D_4
2	1.880	0	3.268
3	1.023	0	2.574
4	0.729	0	2.282
5	0.577	0	2.114
6	0.483	0	2.004
7	0.419	0.076	1.924
8	0.373	0.136	1.864
9	0.337	0.184	1.816
10	0.308	0.223	1.777

X_i = an individual observation

n = the sample size of a group

k = the number of groups

R = (range) the difference between the largest and smallest observations in a sample of size n .

$$\bar{X} = \frac{X_1 + X_2 + \dots + X_n}{n}$$

$$\bar{\bar{X}} = \frac{\bar{X}_1 + \bar{X}_2 + \dots + \bar{X}_k}{k}$$

$$\bar{R} = \frac{R_1 + R_2 + \dots + R_k}{k}$$

The R Chart formulas are:

$$CL_R = \bar{R}$$

$$UCL_R = D_4 \bar{R}$$

$$LCL_R = D_3 \bar{R}$$

The \bar{X} Chart formulas are:

$$CL_X = \bar{\bar{X}}$$

$$UCL_X = \bar{\bar{X}} + A_2 \bar{R}$$

$$LCL_X = \bar{\bar{X}} - A_2 \bar{R}$$

Standard Deviation Charts

n	A_3	B_3	B_4
2	2.659	0	3.267
3	1.954	0	2.568
4	1.628	0	2.266
5	1.427	0	2.089
6	1.287	0.030	1.970
7	1.182	0.119	1.882
8	1.099	0.185	1.815
9	1.032	0.239	1.761
10	0.975	0.284	1.716

$$UCL_X = \bar{\bar{X}} + A_3 \bar{S}$$

$$CL_X = \bar{\bar{X}}$$

$$LCL_X = \bar{\bar{X}} - A_3 \bar{S}$$

$$UCL_S = B_4 \bar{S}$$

$$CL_S = \bar{S}$$

$$LCL_S = B_3 \bar{S}$$

Approximations

The following table and equations may be used to generate initial approximations of the items indicated.

n	c_4	d_2	d_3
2	0.7979	1.128	0.853
3	0.8862	1.693	0.888
4	0.9213	2.059	0.880
5	0.9400	2.326	0.864
6	0.9515	2.534	0.848
7	0.9594	2.704	0.833
8	0.9650	2.847	0.820
9	0.9693	2.970	0.808
10	0.9727	3.078	0.797

$$\hat{\sigma} = \bar{R} / d_2$$

$$\hat{\sigma} = \bar{S} / c_4$$

$$\sigma_R = d_3 \hat{\sigma}$$

$$\sigma_S = \hat{\sigma} \sqrt{1 - c_4^2}$$

where

$\hat{\sigma}$ = an estimate of σ

σ_R = an estimate of the standard deviation of the ranges of the samples

σ_S = an estimate of the standard deviation of the standard deviations of the samples

Tests for Out of Control

1. A single point falls outside the (three sigma) control limits.
2. Two out of three successive points fall on the same side of and more than two sigma units from the center line.
3. Four out of five successive points fall on the same side of and more than one sigma unit from the center line.
4. Eight successive points fall on the same side of the center line.

Probability and Density Functions: Means and Variances

Variable	Equation	Mean	Variance
Binomial Coefficient	$\binom{n}{x} = \frac{n!}{x!(n-x)!}$		
Binomial	$b(x; n, p) = \binom{n}{x} p^x (1-p)^{n-x}$	np	$np(1-p)$
Hyper Geometric	$h(x; n, r, N) = \binom{r}{x} \frac{\binom{N-r}{n-x}}{\binom{N}{n}}$	$\frac{nr}{N}$	$\frac{r(N-r)n(N-n)}{N^2(N-1)}$
Poisson	$f(x; \lambda) = \frac{\lambda^x e^{-\lambda}}{x!}$	λ	λ
Geometric	$g(x; p) = p(1-p)^{x-1}$	$1/p$	$(1-p)/p^2$
Negative Binomial	$f(y; r, p) = \binom{y+r-1}{r-1} p^r (1-p)^y$	r/p	$r(1-p)/p^2$
Multinomial	$f(x_1, \dots, x_k) = \frac{n!}{x_1! \dots x_k!} p_1^{x_1} \dots p_k^{x_k}$	np_i	$np_i(1-p_i)$
Uniform	$f(x) = 1/(b-a)$	$(a+b)/2$	$(b-a)^2/12$
Gamma	$f(x) = \frac{x^{\alpha-1} e^{-x/\beta}}{\beta^\alpha \Gamma(\alpha)}$; $\alpha > 0, \beta > 0$	$\alpha\beta$	$\alpha\beta^2$
Exponential	$f(x) = \frac{1}{\beta} e^{-x/\beta}$	β	β^2
Weibull	$f(x) = \frac{\alpha}{\beta} x^{\alpha-1} e^{-x^\alpha/\beta}$	$\beta^{1/\alpha} \Gamma[(\alpha+1)/\alpha]$	$\beta^{2/\alpha} \left[\Gamma\left(\frac{\alpha+1}{\alpha}\right) - \Gamma^2\left(\frac{\alpha+1}{\alpha}\right) \right]$
Normal	$f(x) = \frac{1}{\sigma\sqrt{2\pi}} e^{-\frac{1}{2}\left(\frac{x-\mu}{\sigma}\right)^2}$	μ	σ^2
Triangular	$f(x) = \begin{cases} \frac{2(x-a)}{(b-a)(m-a)} & \text{if } a \leq x \leq m \\ \frac{2(b-x)}{(b-a)(b-m)} & \text{if } m < x \leq b \end{cases}$	$\frac{a+b+m}{3}$	$\frac{a^2 + b^2 + m^2 - ab - am - bm}{18}$

Chemistry and Biology

Definitions

Avogadro's Number – The number of elementary particles in a mol of a substance.

$$1 \text{ mol} = 1 \text{ gram mole}$$

$$1 \text{ mol} = 6.02 \times 10^{23} \text{ particles}$$

Molarity of Solutions – The number of gram moles of a substance dissolved in a liter of solution.

Molality of Solutions – The number of gram moles of a substance per 1,000 grams of solvent.

Normality of Solutions – The product of the molarity of a solution and the number of valence changes taking place in a reaction.

Molar Volume of an Ideal Gas [at 0°C (32°F) and 1 atm (14.7 psia)]; 22.4 L/(g mole) [359 ft³/(lb mole)].

$$K_{EQ} = \frac{[C]^c [D]^d}{[A]^a [B]^b}$$

where $[x]$ is the thermodynamic activity of x unless otherwise noted

$[x]$ = concentration of x in dilute solution, or

= partial pressure of x , or

= 1 for solids and liquids

Equilibrium Constant of a Chemical Reaction

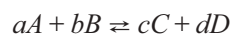

Heats of Reaction, Solution, Formation, and Combustion – Chemical processes generally involve the absorption or evolution of heat. In an endothermic process, heat is absorbed (enthalpy change is positive). In an exothermic process, heat is evolved (enthalpy change is negative).

Solubility Product of a slightly soluble substance AB :



Solubility Product Constant = $K_{SP} = [A^+]^m [B^-]^n$

Faraday's Equation

$$m = \left(\frac{Q}{F}\right) \left(\frac{M}{z}\right)$$

where

m = mass (grams) of substance liberated at electrode

Q = total electric charge passed through electrolyte (coulomb or ampere•second)

F = 96,485 coulombs/mol

M = molar mass of the substance (g/mol)

z = valence number

A *catalyst* is a substance that alters the rate of a chemical reaction. The catalyst does not affect the position of equilibrium of a reversible reaction.

The *atomic number* is the number of protons in the atomic nucleus.

Boiling Point Elevation – The presence of a nonvolatile solute in a solvent raises the boiling point of the resulting solution.

Freezing Point Depression – The presence of a solute lowers the freezing point of the resulting solution.

Nernst Equation

$$\Delta E = (E_2^0 - E_1^0) - \frac{RT}{nF} \ln \left[\frac{M_1^{n+}}{M_2^{n+}} \right]$$

where

E_1^0 = half-cell potential (volts)

R = ideal gas constant (J/kmol•K) [Note: 1J = (1 volt)(1 coulomb)]

n = number of electrons participating in either half-cell reaction (dimensionless)

T = absolute temperature (K)

M_1^{n+} and M_2^{n+} = molar ion concentration (mol/L of solution)

Acids, Bases, and pH (aqueous solutions)

$$\text{pH} = \log_{10} \left(\frac{1}{[H^+]} \right)$$

where

$[H^+]$ = molar concentration of hydrogen ion, in gram moles per liter. Acids have $\text{pH} < 7$. Bases have $\text{pH} > 7$.

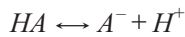

$$K_a = \frac{[A^-][H^+]}{[HA]}$$

$$\text{p}K_a = -\log(K_a)$$

For water $[H^+][OH^-] = 10^{-14}$

[] denotes molarity

Bioconversion

Aerobic Biodegradation of Glucose with No Product, Ammonia Nitrogen Source, Cell Production Only, where Respiration Quotient (RQ) = 1.1



Substrate

Cells

For the above conditions, one finds that:

$$a = 1.94$$

$$b = 0.77$$

$$c = 3.88$$

$$d = 2.13$$

$$e = 3.68$$

The c coefficient represents a theoretical maximum yield coefficient, which may be reduced by a yield factor.

The respiratory quotient (RQ) is a dimensionless number used in calculations of basal metabolic rate when estimated from the ratio of CO_2 produced to the O_2 consumed. The RQ depends on substrates and organisms involved.

Anaerobic Biodegradation of Organic Wastes, Incomplete Stabilization



$$s = a - nw - m$$

$$r = c - ny - 2s$$

Knowledge of product composition, yield coefficient (n) and a methane/ CO_2 ratio is needed.

Anaerobic Biodegradation of Organic Wastes, Complete Stabilization

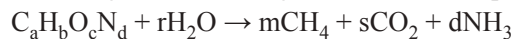

$$r = \frac{4a - b - 2c + 3d}{4}$$

$$s = \frac{4a - b + 2c + 3d}{8}$$

$$m = \frac{4a + b - 2c - 3d}{8}$$

Photosynthesis

Photosynthesis is a most important process form synthesizing glucose from carbon dioxide. It also produces oxygen. The most important photosynthesis reaction is summarized as follows.



The light is required to be in the 400- to 700-nm range (visible light). Chlorophyll is the primary photosynthesis compound and it is found in organisms ranging from tree and plant leaves to single celled algae.

Instrumental Methods of Analysis

Method	Qualitative		Quantitative	
	Elemental	Molecular	Elemental	Molecular
Atomic absorption spectrometry	No	No	Yes	No
Atomic emission spectrometry (AES)	Yes	No	Yes	No
Capillary electrophoresis (CE)	Yes	Yes	Yes	Yes
Electrochemistry	Yes	Yes	Yes	Yes
Gas Chromatography (GC)	No	Yes	No	Yes
ICP-mass spectrometry(ICP MS)	Yes	No	Yes	No
Infrared spectroscopy (IS)	No	Yes	No	Yes
Ion chromatography	Yes	Yes	Yes	Yes
Liquid chromatography (LC)	No	Yes	No	Yes
Mass spectrometry (MS)	Yes	Yes	Yes	Yes
Nuclear Magnetic Resonance (NMR)	No	Yes	No	Yes
Raman spectroscopy	No	Yes	No	Yes
Thermal analysis (TA)	No	Yes	No	Yes
UV and visible (UV/VIS) spectrophotometry	Yes	Yes	Yes	Yes
UV absorption	No	Yes	No	Yes
UV fluorescence	No	Yes	No	Yes
X-ray absorption	Yes	No	Yes	No
X-ray diffraction (XRF)	No	Yes	No	Yes
X-ray fluorescence	Yes	No	Yes	No

Adapted from Robinson, James W., Eileen M. Skelly Frame, George M. Frame II, *Undergraduate Instrumental Analysis*, 6th ed., p. 8.

Periodic Table of Elements

											VIII								
I											2								
1 H 1.0079											4.0026 He								
II												III	IV	V	VI	VII			
3 Li 6.941	4 Be 9.0122											5 B 10.811	6 C 12.011	7 N 14.007	8 O 15.999	9 F 18.998	10 Ne 20.179		
11 Na 22.990	12 Mg 24.305											13 Al 26.981	14 Si 28.086	15 P 30.974	16 S 32.066	17 Cl 35.453	18 Ar 39.948		
19 K 39.098	20 Ca 40.078	21 Sc 44.956	22 Ti 47.88	23 V 50.941	24 Cr 51.996	25 Mn 54.938	26 Fe 55.847	27 Co 58.933	28 Ni 58.69	29 Cu 63.546	30 Zn 65.39	31 Ga 69.723	32 Ge 72.61	33 As 74.921	34 Se 78.96	35 Br 79.904	36 Kr 83.80		
37 Rb 85.468	38 Sr 87.62	39 Y 88.906	40 Zr 91.224	41 Nb 92.906	42 Mo 95.94	43 Tc (98)	44 Ru 101.07	45 Rh 102.91	46 Pd 106.42	47 Ag 107.87	48 Cd 112.41	49 In 114.82	50 Sn 118.71	51 Sb 121.75	52 Te 127.60	53 I 126.90	54 Xe 131.29		
55 Cs 132.91	56 Ba 137.33	57–71	72 Hf 178.49	73 Ta 180.95	74 W 183.85	75 Re 186.21	76 Os 190.2	77 Ir 192.22	78 Pt 195.08	79 Au 196.97	80 Hg 200.59	81 Tl 204.38	82 Pb 207.2	83 Bi 208.98	84 Po (209)	85 At (210)	86 Rn (222)		
87 Fr (223)	88 Ra 226.02	89–103	104 Rf (261)	105 Db (262)	106 Sg (266)	107 Bh (264)	108 Hs (269)	109 Mt (268)	110 Ds (269)	111 Rg (272)	112 Cn (277)	113 Uut unknown	114 F1 (289)	115 Uup unknown	116 Lv (298)	117 Uus unknown	118 Uuo unknown		

88

Chemistry and Biology

Lanthanide Series	57 La 138.91	58 Ce 140.12	59 Pr 140.91	60 Nd 144.24	61 Pm (145)	62 Sm 150.36	63 Eu 151.96	64 Gd 157.25	65 Tb 158.92	66 Dy 162.50	67 Ho 164.93	68 Er 167.26	69 Tm 168.93	70 Yb 173.04	71 Lu 174.97
Actinide Series	89 Ac 227.03	90 Th 232.04	91 Pa 231.04	92 U 238.03	93 Np 237.05	94 Pu (244)	95 Am (243)	96 Cm (247)	97 Bk (247)	98 Cf (251)	99 Es (252)	100 Fm (257)	101 Md (258)	102 No (259)	103 Lr (260)

Selected Rules of Nomenclature in Organic Chemistry

Alcohols

Three systems of nomenclature are in general use. In the first, the alkyl group attached to the hydroxyl group is named and the separate word *alcohol* is added. In the second system, the higher alcohols are considered as derivatives of the first member of the series, which is called *carbinol*. The third method is the modified Geneva system in which (1) the longest carbon chain containing the hydroxyl group determines the surname, (2) the ending *e* of the corresponding saturated hydrocarbon is replaced by *ol*, (3) the carbon chain is numbered from the end that gives the hydroxyl group the smaller number, and (4) the side chains are named and their positions indicated by the proper number. Alcohols in general are divided into three classes. In *primary* alcohols the hydroxyl group is united to a primary carbon atom, that is, a carbon atom united directly to only one other carbon atom. *Secondary* alcohols have the hydroxyl group united to a secondary carbon atom, that is, one united to two other carbon atoms. *Tertiary* alcohols have the hydroxyl group united to a tertiary carbon atom, that is, one united to three other carbon atoms.

Ethers

Ethers are generally designated by naming the alkyl groups and adding the word *ether*. The group RO is known as an *alkoxyl group*. Ethers may also be named as alkoxy derivatives of hydrocarbons.

Carboxylic Acids

The name of each linear carboxylic acid is unique to the number of carbon atoms it contains. 1: (one carbon atom) Formic. 2: Acetic. 3: Propionic. 4: Butyric. 5: Valeric. 6: Caproic. 7: Enanthic. 8: Caprylic. 9: Pelargonic. 10: Capric.

Aldehydes

The common names of aldehydes are derived from the acids that would be formed on oxidation, that is, the acids having the same number of carbon atoms. In general the *ic acid* is dropped and *aldehyde* added.

Ketones

The common names of ketones are derived from the acid which on pyrolysis would yield the ketone. A second method, especially useful for naming mixed ketones, simply names the alkyl groups and adds the word *ketone*. The name is written as three separate words.

Unsaturated Acyclic Hydrocarbons



The simplest compounds in this class of hydrocarbon chemicals are olefins or alkenes with a single carbon-carbon double bond, having the general formula of C_nH_{2n} . The simplest example in this category is ethylene, C_2H_4 .

Dienes are acyclic hydrocarbons with two carbon-carbon double bonds, having the general formula of C_nH_{2n-2} ; butadiene (C_4H_6) is an example of such.

Similarly, trienes have three carbon-carbon double bonds with the general formula of C_nH_{2n-4} ; hexatriene (C_6H_8) is such an example.

The simplest alkynes have a single carbon-carbon triple bond with the general formula of C_nH_{2n-2} . This series of compounds begins with acetylene, or C_2H_2 .

Important Families of Organic Compounds

	FAMILY											
	Alkane	Alkene	Alkyne	Arene	Haloalkane	Alcohol	Ether	Amine	Aldehyde	Ketone	Carboxylic Acid	Ester
Specific Example	CH ₃ CH ₃	H ₂ C = CH ₂	HC ≡ CH		CH ₃ CH ₂ Cl	CH ₃ CH ₂ OH	CH ₃ OCH ₃	CH ₃ NH ₂	$\begin{array}{c} \text{O} \\ \parallel \\ \text{CH}_3\text{CH} \end{array}$	$\begin{array}{c} \text{O} \\ \parallel \\ \text{CH}_3\text{CCH}_3 \end{array}$	$\begin{array}{c} \text{O} \\ \parallel \\ \text{CH}_3\text{COH} \end{array}$	$\begin{array}{c} \text{O} \\ \parallel \\ \text{CH}_3\text{COCH}_3 \end{array}$
IUPAC Name	Ethane	Ethene or Ethylene	Ethyne or Acetylene	Benzene	Chloroethane	Ethanol	Methoxy- methane	Methan- amine	Ethanal	Acetone	Ethanoic Acid	Methyl ethanoate
Common Name	Ethane	Ethylene	Acetylene	Benzene	Ethyl chloride	Ethyl alcohol	Dimethyl ether	Methyl- amine	Acetal- dehyde	Dimethyl ketone	Acetic Acid	Methyl acetate
General Formula	RH	RCH = CH ₂ RCH = CHR R ₂ C = CHR R ₂ C = CR ₂	RC ≡ CH RC ≡ CR	ArH	RX	ROH	ROR	RNH ₂ R ₂ NH R ₃ N	$\begin{array}{c} \text{O} \\ \parallel \\ \text{RCH} \end{array}$	$\begin{array}{c} \text{O} \\ \parallel \\ \text{R}_1\text{CR}_2 \end{array}$	$\begin{array}{c} \text{O} \\ \parallel \\ \text{RCOH} \end{array}$	$\begin{array}{c} \text{O} \\ \parallel \\ \text{RCOR} \end{array}$
Functional Group	C-H and C-C bonds		-C ≡ C-	Aromatic Ring	$\begin{array}{c} \\ -\text{C}-\text{X} \\ \end{array}$	$\begin{array}{c} \\ -\text{C}-\text{OH} \\ \end{array}$	$\begin{array}{c} & \\ -\text{C}-\text{O}-\text{C}- \\ & \end{array}$	$\begin{array}{c} & \\ -\text{C}-\text{N}- \\ & \end{array}$	$\begin{array}{c} \text{O} \\ \parallel \\ -\text{C}-\text{H} \end{array}$	$\begin{array}{c} \text{O} \\ \parallel \\ -\text{C}- \end{array}$	$\begin{array}{c} \text{O} \\ \parallel \\ -\text{C}-\text{OH} \end{array}$	$\begin{array}{c} \text{O} \\ \parallel \\ -\text{C}-\text{O}-\text{C}- \\ \end{array}$

**Common Names and Molecular Formulas of Some Industrial
(Inorganic and Organic) Chemicals**

Common Name	Chemical Name	Molecular Formula
Muriatic acid	Hydrochloric acid	HCl
Cumene	Isopropyl benzene	$C_6H_5CH(CH_3)_2$
Styrene	Vinyl benzene	$C_6H_5CH=CH_2$
—	Hypochlorite ion	OCl^{-1}
—	Chlorite ion	ClO_2^{-1}
—	Chlorate ion	ClO_3^{-1}
—	Perchlorate ion	ClO_4^{-1}
Gypsum	Calcium sulfate	$CaSO_4$
Limestone	Calcium carbonate	$CaCO_3$
Dolomite	Magnesium carbonate	$MgCO_3$
Bauxite	Aluminum oxide	Al_2O_3
Anatase	Titanium dioxide	TiO_2
Rutile	Titanium dioxide	TiO_2
—	Vinyl chloride	$CH_2=CHCl$
—	Ethylene oxide	C_2H_4O
Pyrite	Ferrous sulfide	FeS
Epsom salt	Magnesium sulfate	$MgSO_4$
Hydroquinone	p-Dihydroxy benzene	$C_6H_4(OH)_2$
Soda ash	Sodium carbonate	Na_2CO_3
Salt	Sodium chloride	NaCl
Potash	Potassium carbonate	K_2CO_3
Baking soda	Sodium bicarbonate	$NaHCO_3$
Lye	Sodium hydroxide	NaOH
Caustic soda	Sodium hydroxide	NaOH
—	Vinyl alcohol	$CH_2=CHOH$
Carbolic acid	Phenol	C_6H_5OH
Aniline	Aminobenzene	$C_6H_5NH_2$
—	Urea	$(NH_2)_2CO$
Toluene	Methyl benzene	$C_6H_5CH_3$
Xylene	Dimethyl benzene	$C_6H_4(CH_3)_2$
—	Silane	SiH_4
—	Ozone	O_3
Neopentane	2,2-Dimethylpropane	$CH_3C(CH_3)_2CH_3$
Magnetite	Ferrous/ferric oxide	Fe_3O_4
Quicksilver	Mercury	Hg
Heavy water	Deuterium oxide	2H_2O
—	Borane	BH_3
Eyewash	Boric acid (solution)	H_3BO_3
—	Deuterium	2H
—	Tritium	3H
Laughing gas	Nitrous oxide	N_2O
—	Phosgene	$COCl_2$
Wolfram	Tungsten	W
—	Permanganate ion	MnO_4^{-1}
—	Dichromate ion	$Cr_2O_7^{-2}$
—	Hydronium ion	H_3O^{+1}
Brine	Sodium chloride (solution)	NaCl
Battery acid	Sulfuric acid	H_2SO_4

Electrochemistry

Cathode – The electrode at which reduction occurs.

Anode – The electrode at which oxidation occurs.

Oxidation – The loss of electrons.

Reduction – The gaining of electrons.

Cation – Positive ion

Anion – Negative ion

Standard Oxidation Potentials for Corrosion Reactions*	
Corrosion Reaction	Potential, E_o , Volts vs. Normal Hydrogen Electrode
$\text{Au} \rightarrow \text{Au}^{3+} + 3\text{e}^-$	-1.498
$2\text{H}_2\text{O} \rightarrow \text{O}_2 + 4\text{H}^+ + 4\text{e}^-$	-1.229
$\text{Pt} \rightarrow \text{Pt}^{2+} + 2\text{e}^-$	-1.200
$\text{Pd} \rightarrow \text{Pd}^{2+} + 2\text{e}^-$	-0.987
$\text{Ag} \rightarrow \text{Ag}^+ + \text{e}^-$	-0.799
$2\text{Hg} \rightarrow \text{Hg}_2^{2+} + 2\text{e}^-$	-0.788
$\text{Fe}^{2+} \rightarrow \text{Fe}^{3+} + \text{e}^-$	-0.771
$4(\text{OH})^- \rightarrow \text{O}_2 + 2\text{H}_2\text{O} + 4\text{e}^-$	-0.401
$\text{Cu} \rightarrow \text{Cu}^{2+} + 2\text{e}^-$	-0.337
$\text{Sn}^{2+} \rightarrow \text{Sn}^{4+} + 2\text{e}^-$	-0.150
$\text{H}_2 \rightarrow 2\text{H}^+ + 2\text{e}^-$	0.000
$\text{Pb} \rightarrow \text{Pb}^{2+} + 2\text{e}^-$	+0.126
$\text{Sn} \rightarrow \text{Sn}^{2+} + 2\text{e}^-$	+0.136
$\text{Ni} \rightarrow \text{Ni}^{2+} + 2\text{e}^-$	+0.250
$\text{Co} \rightarrow \text{Co}^{2+} + 2\text{e}^-$	+0.277
$\text{Cd} \rightarrow \text{Cd}^{2+} + 2\text{e}^-$	+0.403
$\text{Fe} \rightarrow \text{Fe}^{2+} + 2\text{e}^-$	+0.440
$\text{Cr} \rightarrow \text{Cr}^{3+} + 3\text{e}^-$	+0.744
$\text{Zn} \rightarrow \text{Zn}^{2+} + 2\text{e}^-$	+0.763
$\text{Al} \rightarrow \text{Al}^{3+} + 3\text{e}^-$	+1.662
$\text{Mg} \rightarrow \text{Mg}^{2+} + 2\text{e}^-$	+2.363
$\text{Na} \rightarrow \text{Na}^+ + \text{e}^-$	+2.714
$\text{K} \rightarrow \text{K}^+ + \text{e}^-$	+2.925

* Measured at 25°C. Reactions are written as anode half-cells. Arrows are reversed for cathode half-cells.

Flinn, Richard A., and Paul K. Trojan, *Engineering Materials and Their Applications*, 4th ed., Houghton Mifflin Company, 1990.

NOTE: In some chemistry texts, the reactions and the signs of the values (in this table) are reversed; for example, the half-cell potential of zinc is given as -0.763 volt for the reaction $\text{Zn}^{2+} + 2\text{e}^- \rightarrow \text{Zn}$. When the potential E_o is positive, the reaction proceeds spontaneously as written.

Cellular Biology

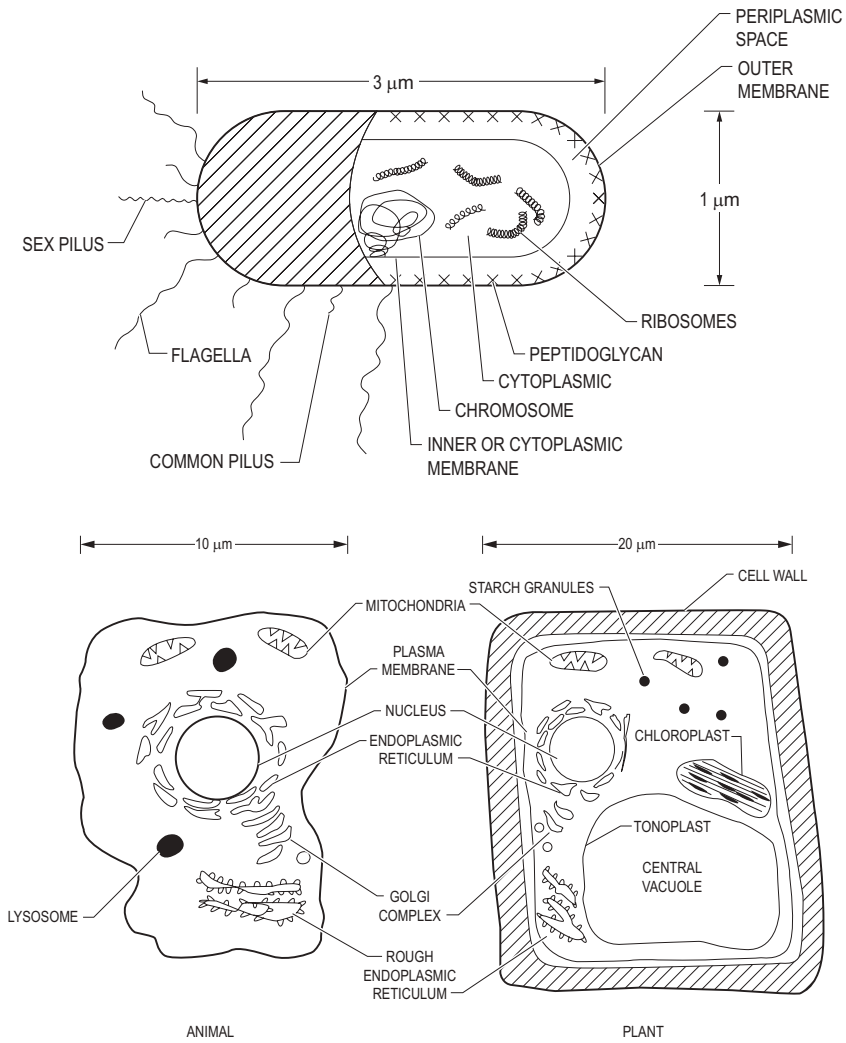

Shuler, Michael L., & Fikret Kargi, *Bioprocess Engineering Basic Concepts*, Prentice Hall PTR, New Jersey, 1992.

Materials Science/Structure of Matter

Atomic Bonding

Primary Bonds

Ionic (e.g., salts, metal oxides)

Covalent (e.g., within polymer molecules)

Metallic (e.g., metals)

Corrosion

A table listing the standard electromotive potentials of metals is shown on the previous page.

For corrosion to occur, there must be an anode and a cathode in electrical contact in the presence of an electrolyte.

Anode Reaction (Oxidation) of a Typical Metal, M



Possible Cathode Reactions (Reduction)

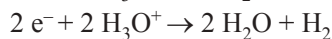
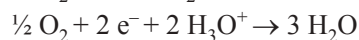

When dissimilar metals are in contact, the more electropositive one becomes the anode in a corrosion cell. Different regions of carbon steel can also result in a corrosion reaction: e.g., cold-worked regions are anodic to noncold-worked; different oxygen concentrations can cause oxygen-deficient regions to become cathodic to oxygen-rich regions; grain boundary regions are anodic to bulk grain; in multiphase alloys, various phases may not have the same galvanic potential.

Diffusion

Diffusion Coefficient

$$D = D_o e^{-Q/(RT)}$$

where

D = diffusion coefficient

D_o = proportionality constant

Q = activation energy

R = gas constant [8.314 J/(mol•K)]

T = absolute temperature

Thermal and Mechanical Processing

Cold working (plastically deforming) a metal increases strength and lowers ductility.

Raising temperature causes (1) recovery (stress relief), (2) recrystallization, and (3) grain growth. *Hot working* allows these processes to occur simultaneously with deformation.

Quenching is rapid cooling from elevated temperature, preventing the formation of equilibrium phases.

In steels, quenching austenite [FCC (γ) iron] can result in martensite instead of equilibrium phases—ferrite [BCC (α) iron] and cementite (iron carbide).

Properties of Materials

Electrical

Capacitance: The charge-carrying capacity of an insulating material

Charge held by a capacitor

$$q = CV$$

where

q = charge

C = capacitance

V = voltage

Capacitance of a parallel plate capacitor

$$C = \frac{\epsilon A}{d}$$

where

C = capacitance

ϵ = permittivity of material

A = cross-sectional area of the plates

d = distance between the plates

ϵ is also expressed as the product of the dielectric constant (κ) and the permittivity of free space ($\epsilon_0 = 8.85 \times 10^{-12}$ F/m)

Resistivity: The material property that determines the resistance of a resistor

Resistivity of a material within a resistor

$$\rho = \frac{RA}{L}$$

where

ρ = resistivity of the material

R = resistance of the resistor

A = cross-sectional area of the resistor

L = length of the resistor

Conductivity is the reciprocal of the resistivity

Photoelectric effect—electrons are emitted from matter (metals and nonmetallic solids, liquids or gases) as a consequence of their absorption of energy from electromagnetic radiation of very short wavelength and high frequency.

Piezoelectric effect—the electromechanical and the electrical state in crystalline materials.

Mechanical

Strain is defined as change in length per unit length; for pure tension the following apply:

Engineering strain

$$\varepsilon = \frac{\Delta L}{L_0}$$

where

ε = engineering strain

ΔL = change in length

L_0 = initial length

True strain

$$\varepsilon_T = \frac{dL}{L}$$

where

ε_T = true strain

dL = differential change in length

L = initial length

$\varepsilon_T = \ln(1 + \varepsilon)$

Properties of Metals

Metal	Symbol	Atomic Weight	Density ρ (kg/m ³) Water = 1000	Melting Point (°C)	Melting Point (°F)	Specific Heat (J/(kg·K))	Electrical Resistivity (10 ⁻⁸ Ω ·m) at 0°C (273.2 K)	Heat Conductivity λ (W/(m·K)) at 0°C (273.2 K)
Aluminum	Al	26.98	2,698	660	1,220	895.9	2.5	236
Antimony	Sb	121.75	6,692	630	1,166	209.3	39	25.5
Arsenic	As	74.92	5,776	subl. 613	subl. 1,135	347.5	26	–
Barium	Ba	137.33	3,594	710	1,310	284.7	36	–
Beryllium	Be	9.012	1,846	1,285	2,345	2,051.5	2.8	218
Bismuth	Bi	208.98	9,803	271	519	125.6	107	8.2
Cadmium	Cd	112.41	8,647	321	609	234.5	6.8	97
Caesium	Cs	132.91	1,900	29	84	217.7	18.8	36
Calcium	Ca	40.08	1,530	840	1,544	636.4	3.2	–
Cerium	Ce	140.12	6,711	800	1,472	188.4	7.3	11
Chromium	Cr	52	7,194	1,860	3,380	406.5	12.7	96.5
Cobalt	Co	58.93	8,800	1,494	2,721	431.2	5.6	105
Copper	Cu	63.54	8,933	1,084	1,983	389.4	1.55	403
Gallium	Ga	69.72	5,905	30	86	330.7	13.6	41
Gold	Au	196.97	19,281	1,064	1,947	129.8	2.05	319
Indium	In	114.82	7,290	156	312	238.6	8	84
Iridium	Ir	192.22	22,550	2,447	4,436	138.2	4.7	147
Iron	Fe	55.85	7,873	1,540	2,804	456.4	8.9	83.5
Lead	Pb	207.2	11,343	327	620	129.8	19.2	36
Lithium	Li	6.94	533	180	356	4,576.2	8.55	86
Magnesium	Mg	24.31	1,738	650	1,202	1,046.7	3.94	157
Manganese	Mn	54.94	7,473	1,250	2,282	502.4	138	8
Mercury	Hg	200.59	13,547	–39	–38	142.3	94.1	7.8
Molybdenum	Mo	95.94	10,222	2,620	4,748	272.1	5	139
Nickel	Ni	58.69	8,907	1,455	2,651	439.6	6.2	94
Niobium	Nb	92.91	8,578	2,425	4,397	267.9	15.2	53
Osmium	Os	190.2	22,580	3,030	5,486	129.8	8.1	88
Palladium	Pd	106.4	11,995	1,554	2,829	230.3	10	72
Platinum	Pt	195.08	21,450	1,772	3,221	134	9.81	72
Potassium	K	39.09	862	63	145	753.6	6.1	104
Rhodium	Rh	102.91	12,420	1,963	3,565	242.8	4.3	151
Rubidium	Rb	85.47	1,533	38.8	102	330.7	11	58
Ruthenium	Ru	101.07	12,360	2,310	4,190	255.4	7.1	117
Silver	Ag	107.87	10,500	961	1,760	234.5	1.47	428
Sodium	Na	22.989	966	97.8	208	1,235.1	4.2	142
Strontium	Sr	87.62	2,583	770	1,418	–	20	–
Tantalum	Ta	180.95	16,670	3,000	5,432	150.7	12.3	57
Thallium	Tl	204.38	11,871	304	579	138.2	10	10
Thorium	Th	232.04	11,725	1,700	3,092	117.2	14.7	54
Tin	Sn	118.69	7,285	232	449	230.3	11.5	68
Titanium	Ti	47.88	4,508	1,670	3,038	527.5	39	22
Tungsten	W	183.85	19,254	3,387	6,128	142.8	4.9	177
Uranium	U	238.03	19,050	1,135	2,075	117.2	28	27
Vanadium	V	50.94	6,090	1,920	3,488	481.5	18.2	31
Zinc	Zn	65.38	7,135	419	786	393.5	5.5	117
Zirconium	Zr	91.22	6,507	1,850	3,362	284.7	40	23

Some Extrinsic, Elemental Semiconductors

Element	Dopant	Periodic table group of dopant	Maximum solid solubility of dopant (atoms/m ³)
Si	B	III A	600×10^{24}
	Al	III A	20×10^{24}
	Ga	III A	40×10^{24}
	P	V A	$1,000 \times 10^{24}$
	As	V A	$2,000 \times 10^{24}$
	Sb	V A	70×10^{24}
Ge	Al	III A	400×10^{24}
	Ga	III A	500×10^{24}
	In	III A	4×10^{24}
	As	V A	80×10^{24}
	Sb	V A	10×10^{24}

Impurity Energy Levels for Extrinsic Semiconductors

Semiconductor	Dopant	$E_g - E_d$ (eV)	E_a (eV)
Si	P	0.044	–
	As	0.049	–
	Sb	0.039	–
	Bi	0.069	–
	B	–	0.045
	Al	–	0.057
	Ga	–	0.065
	In	–	0.160
	Tl	–	0.260
Ge	P	0.012	–
	As	0.013	–
	Sb	0.096	–
	B	–	0.010
	Al	–	0.010
	Ga	–	0.010
	In	–	0.011
	Tl	–	0.01
GaAs	Se	0.005	–
	Te	0.003	–
	Zn	–	0.024
	Cd	–	0.021

Runyan, W.R., and S.B. Watelski, *Handbook of Materials and Processes for Electronics*, C.A. Harper, ed., New York: McGraw-Hill, 1970.

Stress is defined as force per unit area; for pure tension the following apply:

Engineering stress

$$\sigma = \frac{F}{A_0}$$

where

σ = engineering stress

F = applied force

A_0 = initial cross-sectional area

True stress

$$\sigma_T = \frac{F}{A}$$

where

σ_T = true stress

F = applied force

A = actual cross-sectional area

The elastic modulus (also called modulus, modulus of elasticity, Young's modulus) describes the relationship between engineering stress and engineering strain during elastic loading. Hooke's Law applies in such a case.

$$\sigma = E\varepsilon$$

where E = elastic modulus

Key mechanical properties obtained from a tensile test curve:

- Elastic modulus
- Ductility (also called percent elongation): Permanent engineering strain after failure
- Ultimate tensile strength (also called tensile strength): Maximum engineering stress
- Yield strength: Engineering stress at which permanent deformation is first observed, calculated by 0.2% offset method.

Other mechanical properties:

- Creep: Time-dependent deformation under load. Usually measured by strain rate. For steady-state creep this is:

$$\frac{d\varepsilon}{dt} = A\sigma^n e^{-\frac{Q}{RT}}$$

where

A = pre-exponential constant

n = stress sensitivity

Q = activation energy for creep

R = ideal gas law constant

T = absolute temperature

- Fatigue: Time-dependent failure under cyclic load. Fatigue life is the number of cycles to failure. The endurance limit is the stress below which fatigue failure is unlikely.

$$R = \frac{\sigma_{\min}}{\sigma_{\max}}$$

where R = stress ratio

For $R = -1$ and high cycle fatigue, based on the Basquin equation:

$$N = \left(\frac{\sigma_r}{A}\right)^{\frac{1}{B}}$$

where

N = cycles to failure

σ_r = completely (fully) reversed stress

A and B = material constants

- Fracture toughness: The combination of applied stress and the crack length in a brittle material. It is the stress intensity when the material will fail.

$$K_{IC} = Y\sigma\sqrt{\pi a}$$

where

K_{IC} = fracture toughness

σ = applied engineering stress

a = crack length

Y = geometrical factor

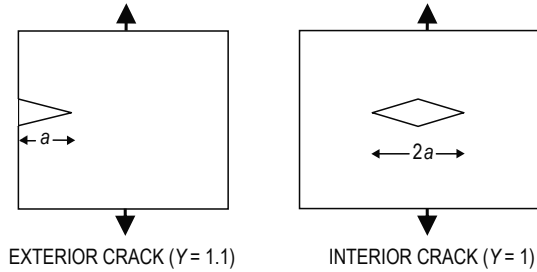

The critical value of stress intensity at which catastrophic crack propagation occurs, K_{Ic} , is a material property.

Representative Values of Fracture Toughness

Material	K_{Ic} (MPa·m ^{1/2})	K_{Ic} (ksi-in ^{1/2})
A1 2014-T651	24.2	22
A1 2024-T3	44	40
52100 Steel	14.3	13
4340 Steel	46	42
Alumina	4.5	4.1
Silicon Carbide	3.5	3.2

Relationship Between Hardness and Tensile Strength

For plain carbon steels, there is a general relationship between Brinell hardness and tensile strength as follows:

$$TS(\text{psi}) \simeq 500 \text{ BHN}$$

$$TS(\text{MPa}) \simeq 3.5 \text{ BHN}$$

ASTM Grain Size

$$S_V = 2P_L$$

$$N_{(0.0645 \text{ mm}^2)} = 2^{(n-1)}$$

$$\frac{N_{\text{actual}}}{\text{Actual Area}} = \frac{N}{(0.0645 \text{ mm}^2)}$$

where

S_V = grain-boundary surface per unit volume

P_L = number of points of intersection per unit length between the line and the boundaries

N = number of grains observed in an area of 0.0645 mm²

n = grain size (nearest integer > 1)

Composite Materials

$$\rho_c = \sum f_i \rho_i$$

$$C_c = \sum f_i c_i$$

$$\left[\sum \frac{f_i}{E_i} \right]^{-1} \leq E_c \leq \sum f_i E_i$$

$$\sigma_c = \sum f_i \sigma_i$$

where

ρ_c = density of composite

C_c = heat capacity of composite per unit volume

E_c = Young's modulus of composite

f_i = volume fraction of individual material

c_i = heat capacity of individual material per unit volume

E_i = Young's modulus of individual material

σ_c = strength parallel to fiber direction

Also, for axially oriented, long, fiber-reinforced composites, the strains of the two components are equal.

$$(\Delta L/L)_1 = (\Delta L/L)_2$$

where

ΔL = change in length of the composite

L = original length of the composite

Hardenability

Hardness: Resistance to penetration. Measured by denting a material under known load and measuring the size of the dent.

Hardenability: The "ease" with which hardness can be obtained.

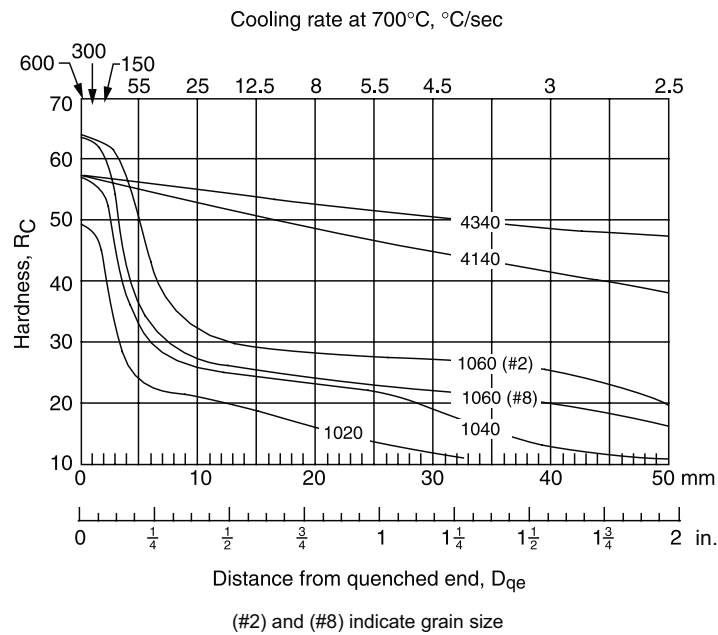

JOMINY HARDENABILITY CURVES FOR SIX STEELS

The following two graphs show cooling curves for four different positions in the bar.

C = Center

M-R = Halfway between center and surface

3/4-R = 75% of the distance between the center and the surface

S = Surface

These positions are shown in the following figure.

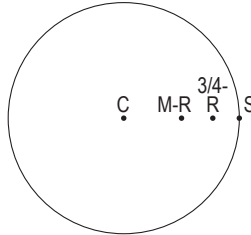

COOLING RATES FOR BARS QUENCHED IN AGITATED WATER

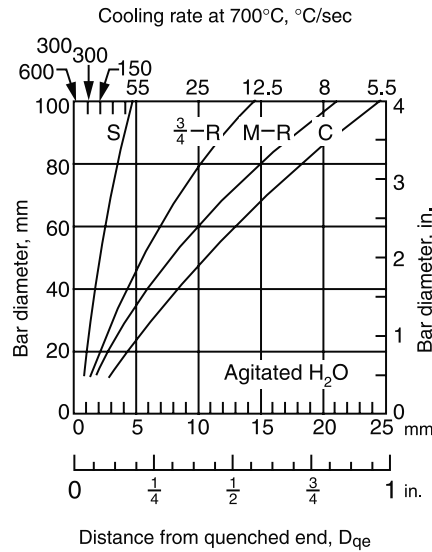

COOLING RATES FOR BARS QUENCHED IN AGITATED OIL

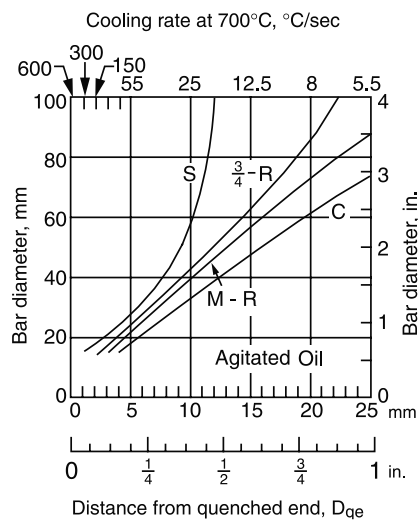

Impact Test

The *Charpy Impact Test* is used to find energy required to fracture and to identify ductile to brittle transition.

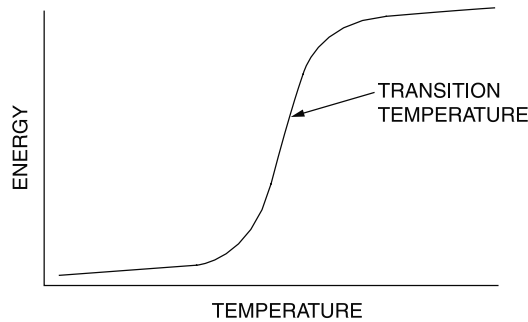

Impact tests determine the amount of energy required to cause failure in standardized test samples. The tests are repeated over a range of temperatures to determine the *ductile to brittle transition temperature*.

Concrete

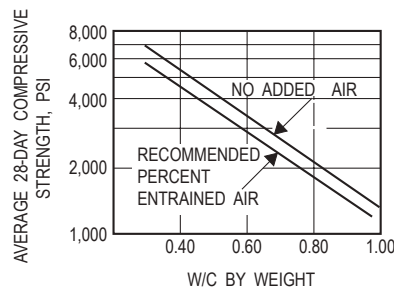

Concrete strength decreases with increases in water-cement ratio for concrete with and without entrained air.

Concrete Manual, 8th ed., U.S. Bureau of Reclamation, 1975.

Water-cement (W/C) ratio is the primary factor affecting the strength of concrete. The figure above shows how W/C expressed as a ratio of weight of water and cement by weight of concrete mix affects the compressive strength of both air-entrained and non-air-entrained concrete.

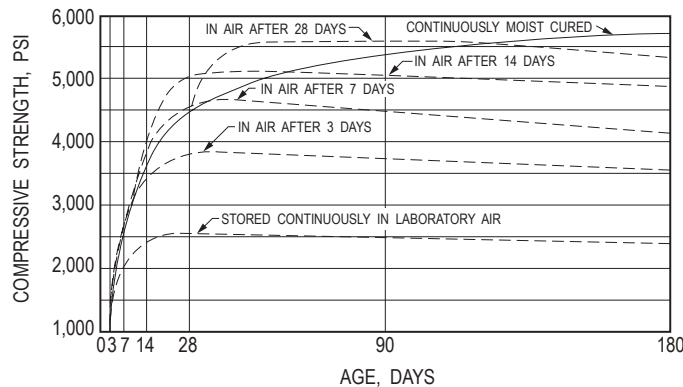

Concrete compressive strength varies with moist-curing conditions. Mixes tested had a water-cement ratio of 0.50, a slump of 3.5 in., cement content of 556 lb/yd³, sand content of 36%, and air content of 4%.

Merritt, Frederick S., *Standard Handbook for Civil Engineers*, 3rd ed., McGraw-Hill, 1983.

Water content affects workability. However, an increase in water without a corresponding increase in cement reduces the concrete strength. Superplasticizers are the most typical way to increase workability. Air entrainment is used to improve durability.

Amorphous Materials

Amorphous materials such as glass are non-crystalline solids.

Thermoplastic polymers are either semicrystalline or amorphous.

Below the glass transition temperature (T_g) the amorphous material will be a brittle solid.

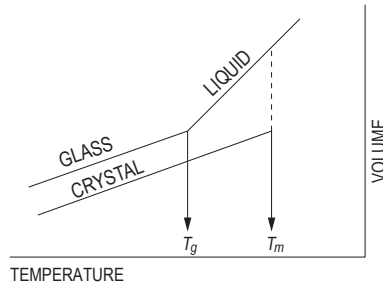

The volume temperature curve as shown above is often used to show the difference between amorphous and crystalline solids.

Polymers

Polymers are classified as thermoplastics that can be melted and reformed. Thermosets cannot be melted and reformed.

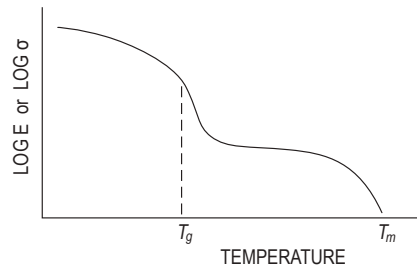

The above curve shows the temperature dependent strength (σ) or modulus (E) for a thermoplastic polymer.

Polymer Additives

Chemicals and compounds are added to polymers to improve properties for commercial use. These substances, such as plasticizers, improve formability during processing, while others increase strength or durability.

Examples of common additives are:

Plasticizers: vegetable oils, low molecular weight polymers or monomers

Fillers: talc, chopped glass fibers

Flame retardants: halogenated paraffins, zinc borate, chlorinated phosphates

Ultraviolet or visible light resistance: carbon black

Oxidation resistance: phenols, aldehydes

Thermal Properties

The thermal expansion coefficient is the ratio of engineering strain to the change in temperature.

$$\alpha = \frac{\epsilon}{\Delta T}$$

where

α = thermal expansion coefficient

ϵ = engineering strain

ΔT = change in temperature

Iron-Iron Carbide Phase Diagram

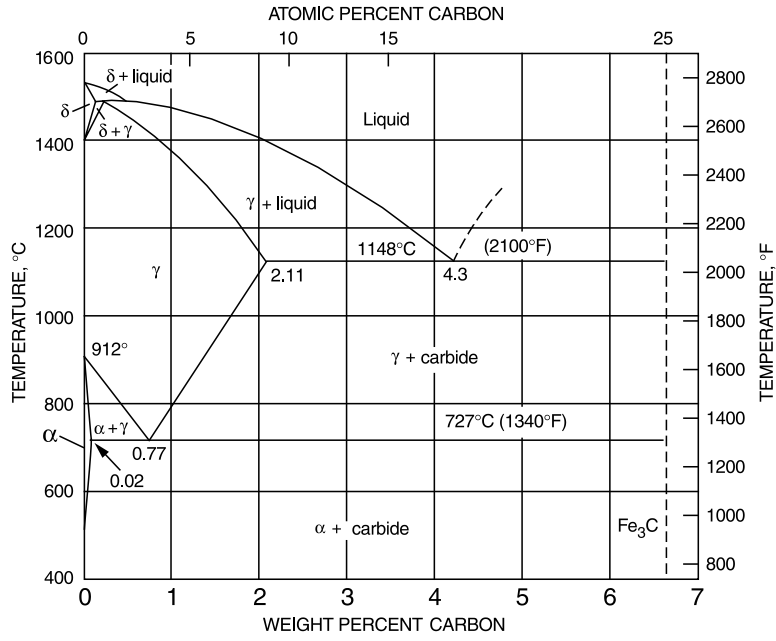

Van Vlack, L.H., *Elements of Materials Science and Engineering*, 6th ed., ©1989. Reprinted by permission of Pearson Education, Inc., New, New York.

Statics

Force

A *force* is a *vector* quantity. It is defined when its (1) magnitude, (2) point of application, and (3) direction are known.

The vector form of a force is

$$\mathbf{F} = F_x \mathbf{i} + F_y \mathbf{j}$$

Resultant (Two Dimensions)

The *resultant*, F , of n forces with components $F_{x,i}$ and $F_{y,i}$ has the magnitude of

$$F = \left[\left(\sum_{i=1}^n F_{x,i} \right)^2 + \left(\sum_{i=1}^n F_{y,i} \right)^2 \right]^{1/2}$$

The resultant direction with respect to the x -axis is

$$\theta = \arctan \left(\frac{\sum_{i=1}^n F_{y,i}}{\sum_{i=1}^n F_{x,i}} \right)$$

Resolution of a Force

$$\begin{aligned} F_x &= F \cos \theta_x & F_y &= F \cos \theta_y & F_z &= F \cos \theta_z \\ \cos \theta_x &= F_x/F & \cos \theta_y &= F_y/F & \cos \theta_z &= F_z/F \end{aligned}$$

Separating a force into components when the geometry of force is known and $R = \sqrt{x^2 + y^2 + z^2}$

$$F_x = (x/R)F \quad F_y = (y/R)F \quad F_z = (z/R)F$$

Moments (Couples)

A system of two forces that are equal in magnitude, opposite in direction, and parallel to each other is called a *couple*. A *moment* \mathbf{M} is defined as the cross product of the *radius vector* \mathbf{r} and the *force* \mathbf{F} from a point to the line of action of the force.

$$\begin{aligned} \mathbf{M} &= \mathbf{r} \times \mathbf{F} \\ M_x &= yF_z - zF_y \\ M_y &= zF_x - xF_z \\ M_z &= xF_y - yF_x \end{aligned}$$

Systems of Forces

$$\begin{aligned} \mathbf{F} &= \sum \mathbf{F}_n \\ \mathbf{M} &= \sum (\mathbf{r}_n \times \mathbf{F}_n) \end{aligned}$$

Equilibrium Requirements

$$\begin{aligned} \sum \mathbf{F}_n &= 0 \\ \sum \mathbf{M}_n &= 0 \end{aligned}$$

Centroids of Masses, Areas, Lengths, and Volumes

The following formulas are for discrete masses, areas, lengths, and volumes:

$$\mathbf{r}_c = \Sigma m_n \mathbf{r}_n / \Sigma m_n$$

where

m_n = mass of each particle making up the system

\mathbf{r}_n = radius vector to each particle from a selected reference point

\mathbf{r}_c = radius vector to the centroid of the total mass from the selected reference point

The *moment of area* (M_a) is defined as

$$M_{ay} = \Sigma x_n a_n$$

$$M_{ax} = \Sigma y_n a_n$$

The *centroid of area* is defined as

$$x_{ac} = M_{ay} / A = \Sigma x_n a_n / A$$

$$y_{ac} = M_{ax} / A = \Sigma y_n a_n / A$$

where $A = \Sigma a_n$

The following equations are for an area, bounded by the axes and the function $y = f(x)$. The centroid of area is defined as

$$x_c = \frac{\int x dA}{A}$$

$$y_c = \frac{\int y dA}{A}$$

$$A = \int f(x) dx$$

$$dA = f(x) dx = g(y) dy$$

The *first moment of area* with respect to the y -axis and the x -axis, respectively, are:

$$M_y = \int x dA = x_c A$$

$$M_x = \int y dA = y_c A$$

Moment of Inertia

The *moment of inertia*, or the second moment of area, is defined as

$$I_y = \int x^2 dA$$

$$I_x = \int y^2 dA$$

The *polar moment of inertia* J of an area about a point is equal to the sum of the moments of inertia of the area about any two perpendicular axes in the area and passing through the same point.

$$\begin{aligned} I_z &= J = I_y + I_x = \int (x^2 + y^2) dA \\ &= r_p^2 A \end{aligned}$$

where r_p = the radius of gyration (as defined below)

Moment of Inertia Parallel Axis Theorem

The moment of inertia of an area about any axis is defined as the moment of inertia of the area about a parallel centroidal axis plus a term equal to the area multiplied by the square of the perpendicular distance d from the centroidal axis to the axis in question.

$$I_x = I_{x_c} + d_y^2 A$$

$$I_y = I_{y_c} + d_x^2 A$$

where

d_x, d_y = distance between the two axes in question

I_{x_c}, I_{y_c} = moment of inertia about the centroidal axis

I_x, I_y = moment of inertia about the new axis

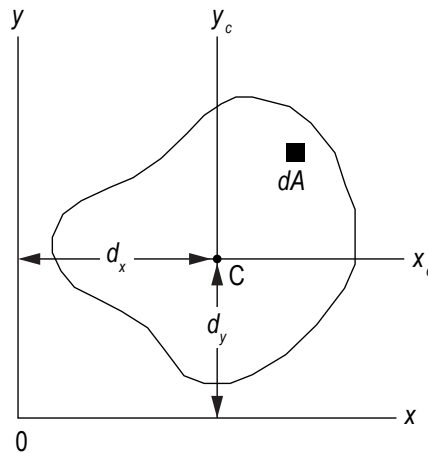

Hibbeler, R.C., *Engineering Mechanics: Statics and Dynamics*, 10 ed., Pearson Prentice Hall, 2004.

Radius of Gyration

The *radius of gyration* r_p, r_x, r_y is the distance from a reference axis at which all of the area can be considered to be concentrated to produce the moment of inertia.

$$r_x = \sqrt{I_x/A} \quad r_y = \sqrt{I_y/A} \quad r_p = \sqrt{J/A}$$

Product of Inertia

The *product of inertia* (I_{xy} , etc.) is defined as:

$$I_{xy} = \int xy dA, \text{ with respect to the } xy\text{-coordinate system}$$

The *parallel-axis theorem* also applies:

$$I'_{xy} = I_{x_c y_c} + d_x d_y A \text{ for the } xy\text{-coordinate system, etc.}$$

where

d_x = x-axis distance between the two axes in question

d_y = y-axis distance between the two axes in question

Friction

The largest frictional force is called the *limiting friction*. Any further increase in applied forces will cause motion.

$$F \leq \mu_s N$$

where

F = friction force

μ_s = coefficient of static friction

N = normal force between surfaces in contact

Screw Thread

For a *screw-jack, square thread*,

$$M = Pr \tan (\alpha \pm \phi)$$

where

+ is for screw tightening

– is for screw loosening

M = external moment applied to axis of screw

P = load on jack applied along and on the line of the axis

r = mean thread radius

α = pitch angle of the thread

$\mu = \tan \phi$ = appropriate coefficient of friction

Belt Friction

$$F_1 = F_2 e^{\mu\theta}$$

where

F_1 = force being applied in the direction of impending motion

F_2 = force applied to resist impending motion

μ = coefficient of static friction

θ = total angle of contact between the surfaces expressed in radians

Statically Determinate Truss

Plane Truss: Method of Joints

The method consists of solving for the forces in the members by writing the two equilibrium equations for each joint of the truss.

$$\Sigma F_H = 0 \text{ and } \Sigma F_V = 0$$

where

F_H = horizontal forces and member components

F_V = vertical forces and member components

Plane Truss: Method of Sections

The method consists of drawing a free-body diagram of a portion of the truss in such a way that the unknown truss member force is exposed as an external force.

Concurrent Forces

A concurrent-force system is one in which the lines of action of the applied forces all meet at one point.

A *two-force* body in static equilibrium has two applied forces that are equal in magnitude, opposite in direction, and collinear.

Figure	Area & Centroid	Area Moment of Inertia	(Radius of Gyration) ²	Product of Inertia
	$A = bh/2$ $x_c = 2b/3$ $y_c = h/3$	$I_{x_c} = bh^3/36$ $I_{y_c} = b^3h/36$ $I_x = bh^3/12$ $I_y = b^3h/4$	$r_{x_c}^2 = h^2/18$ $r_{y_c}^2 = b^2/18$ $r_x^2 = h^2/6$ $r_y^2 = b^2/2$	$I_{x_c y_c} = Abh/36 = b^2h^2/72$ $I_{xy} = Abh/4 = b^2h^2/8$
	$A = bh/2$ $x_c = b/3$ $y_c = h/3$	$I_{x_c} = bh^3/36$ $I_{y_c} = b^3h/36$ $I_x = bh^3/12$ $I_y = b^3h/12$	$r_{x_c}^2 = h^2/18$ $r_{y_c}^2 = b^2/18$ $r_x^2 = h^2/6$ $r_y^2 = b^2/6$	$I_{x_c y_c} = -Abh/36 = -b^2h^2/72$ $I_{xy} = Abh/12 = b^2h^2/24$
	$A = bh/2$ $x_c = (a+b)/3$ $y_c = h/3$	$I_{x_c} = bh^3/36$ $I_{y_c} = [bh(b^2 - ab + a^2)]/36$ $I_x = bh^3/12$ $I_y = [bh(b^2 + ab + a^2)]/12$	$r_{x_c}^2 = h^2/18$ $r_{y_c}^2 = (b^2 - ab + a^2)/18$ $r_x^2 = h^2/6$ $r_y^2 = (b^2 + ab + a^2)/6$	$I_{x_c y_c} = [Ah(2a - b)]/36$ $= [bh^2(2a - b)]/72$ $I_{xy} = [Ah(2a + b)]/12$ $= [bh^2(2a + b)]/24$
	$A = bh$ $x_c = b/2$ $y_c = h/2$	$I_{x_c} = bh^3/12$ $I_{y_c} = b^3h/12$ $I_x = bh^3/3$ $I_y = b^3h/3$ $J = [bh(b^2 + h^2)]/12$	$r_{x_c}^2 = h^2/12$ $r_{y_c}^2 = b^2/12$ $r_x^2 = h^2/3$ $r_y^2 = b^2/3$ $r_p^2 = (b^2 + h^2)/12$	$I_{x_c y_c} = 0$ $I_{xy} = Abh/4 = b^2h^2/4$
	$A = h(a+b)/2$ $y_c = \frac{h(2a+b)}{3(a+b)}$	$I_{x_c} = \frac{h^3(a^2 + 4ab + b^2)}{36(a+b)}$ $I_x = \frac{h^3(3a+b)}{12}$	$r_{x_c}^2 = \frac{h^2(a^2 + 4ab + b^2)}{18(a+b)}$ $r_x^2 = \frac{h^2(3a+b)}{6(a+b)}$	
	$A = ab \sin \theta$ $x_c = (b + a \cos \theta)/2$ $y_c = (a \sin \theta)/2$	$I_{x_c} = (a^3 b \sin^3 \theta)/12$ $I_{y_c} = [ab \sin \theta (b^2 + a^2 \cos^2 \theta)]/12$ $I_x = (a^3 b \sin^3 \theta)/3$ $I_y = [ab \sin \theta (b + a \cos \theta)^2]/3$ $- (a^2 b^2 \sin \theta \cos \theta)/6$	$r_{x_c}^2 = (a \sin \theta)^2/12$ $r_{y_c}^2 = (b^2 + a^2 \cos^2 \theta)/12$ $r_x^2 = (a \sin \theta)^2/3$ $r_y^2 = (b + a \cos \theta)^2/3$ $- (ab \cos \theta)/6$	$I_{x_c y_c} = (a^3 b \sin^2 \theta \cos \theta)/12$

Figure	Area & Centroid	Area Moment of Inertia	(Radius of Gyration) ²	Product of Inertia
	$A = \pi a^2$ $x_c = a$ $y_c = a$	$I_{x_c} = I_{y_c} = \pi a^4/4$ $I_x = I_y = 5\pi a^4/4$ $J = \pi a^4/2$	$r_{x_c}^2 = r_{y_c}^2 = a^2/4$ $r_x^2 = r_y^2 = 5a^2/4$ $r_p^2 = a^2/2$	$I_{x_c y_c} = 0$ $I_{xy} = Aa^2$
	$A = \pi(a^2 - b^2)$ $x_c = a$ $y_c = a$	$I_{x_c} = I_{y_c} = \pi(a^4 - b^4)/4$ $I_x = I_y = \frac{5\pi a^4}{4} - \pi a^2 b^2 - \frac{\pi b^4}{4}$ $J = \pi(a^4 - b^4)/2$	$r_{x_c}^2 = r_{y_c}^2 = (a^2 + b^2)/4$ $r_x^2 = r_y^2 = (5a^2 + b^2)/4$ $r_p^2 = (a^2 + b^2)/2$	$I_{x_c y_c} = 0$ $I_{xy} = Aa^2$ $= \pi a^2(a^2 - b^2)$
	$A = \pi a^2/2$ $x_c = a$ $y_c = 4a/(3\pi)$	$I_{x_c} = \frac{a^4(9\pi^2 - 64)}{72\pi}$ $I_{y_c} = \pi a^4/8$ $I_x = \pi a^4/8$ $I_y = 5\pi a^4/8$	$r_{x_c}^2 = \frac{a^2(9\pi^2 - 64)}{36\pi^2}$ $r_{y_c}^2 = a^2/4$ $r_x^2 = a^2/4$ $r_y^2 = 5a^2/4$	$I_{x_c y_c} = 0$ $I_{xy} = 2a^4/3$
	$A = a^2\theta$ $x_c = \frac{2a \sin\theta}{3\theta}$ $y_c = 0$	$I_x = a^4(\theta - \sin\theta \cos\theta)/4$ $I_y = a^4(\theta + \sin\theta \cos\theta)/4$	$r_x^2 = \frac{a^2(\theta - \sin\theta \cos\theta)}{4\theta}$ $r_y^2 = \frac{a^2(\theta + \sin\theta \cos\theta)}{4\theta}$	$I_{x_c y_c} = 0$ $I_{xy} = 0$
	$A = a^2 \left[\theta - \frac{\sin 2\theta}{2} \right]$ $x_c = \frac{2a}{3} \frac{\sin^3 \theta}{\theta - \sin\theta \cos\theta}$ $y_c = 0$	$I_x = \frac{Aa^2}{4} \left[1 - \frac{2\sin^3 \theta \cos\theta}{3\theta - 3\sin\theta \cos\theta} \right]$ $I_y = \frac{Aa^2}{4} \left[1 + \frac{2\sin^3 \theta \cos\theta}{\theta - \sin\theta \cos\theta} \right]$	$r_x^2 = \frac{a^2}{4} \left[1 - \frac{2\sin^3 \theta \cos\theta}{3\theta - 3\sin\theta \cos\theta} \right]$ $r_y^2 = \frac{a^2}{4} \left[1 + \frac{2\sin^3 \theta \cos\theta}{\theta - \sin\theta \cos\theta} \right]$	$I_{x_c y_c} = 0$ $I_{xy} = 0$

Figure	Area & Centroid	Area Moment of Inertia	(Radius of Gyration) ²	Product of Inertia
 <p>PARABOLA</p>	$A = 4ab/3$ $x_c = 3a/5$ $y_c = 0$	$I_{x_c} = I_x = 4ab^3/15$ $I_{y_c} = 16a^3b/175$ $I_y = 4a^3b/7$	$r_{x_c}^2 = r_x^2 = b^2/5$ $r_{y_c}^2 = 12a^2/175$ $r_y^2 = 3a^2/7$	$I_{x_c y_c} = 0$ $I_{xy} = 0$
 <p>HALF A PARABOLA</p>	$A = 2ab/3$ $x_c = 3a/5$ $y_c = 3b/8$	$I_x = 2ab^3/15$ $I_y = 2ba^3/7$	$r_x^2 = b^2/5$ $r_y^2 = 3a^2/7$	$I_{xy} = Aab/4 = a^2b^2$
 <p>nth DEGREE PARABOLA</p>	$A = bh/(n+1)$ $x_c = \frac{n+1}{n+2}b$ $y_c = \frac{h}{2} \frac{n+1}{2n+1}$	$I_x = \frac{bh^3}{3(3n+1)}$ $I_y = \frac{hb^3}{n+3}$	$r_x^2 = \frac{h^2(n+1)}{3(3n+1)}$ $r_y^2 = \frac{n+1}{n+3}b^2$	
 <p>nth DEGREE PARABOLA</p>	$A = \frac{n}{n+1}bh$ $x_c = \frac{n+1}{2n+1}b$ $y_c = \frac{n+1}{2(n+2)}h$	$I_x = \frac{n}{3(n+3)}bh^3$ $I_y = \frac{n}{3n+1}b^3h$	$r_x^2 = \frac{n+1}{3(n+1)}h^2$ $r_y^2 = \frac{n+1}{3n+1}b^2$	

Housner, George W., and Donald E. Hudson, *Applied Mechanics Dynamics*, D. Van Nostrand Company, Inc., Princeton, NJ, 1959. Table reprinted by permission of G.W. Housner & D.E. Hudson.

Dynamics

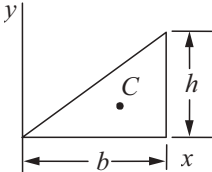
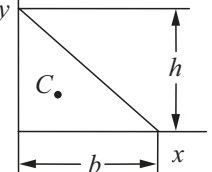
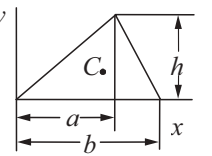
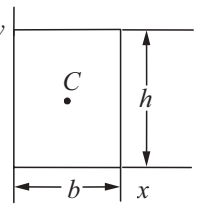
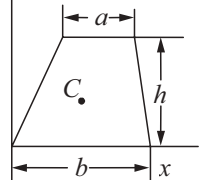
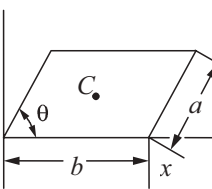
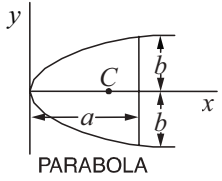
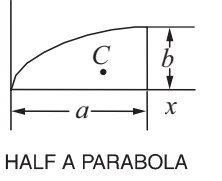
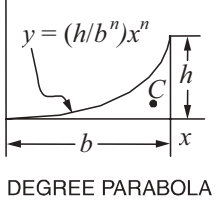
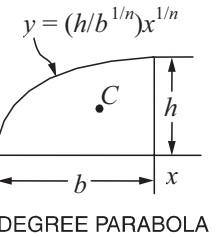
Common Nomenclature

- t = time
- s = position coordinate, measured along a curve from an origin
- v = velocity
- a = acceleration
- a_n = normal acceleration
- a_t = tangential acceleration
- θ = angular position coordinate
- ω = angular velocity
- α = angular acceleration
- Ω = angular velocity of x,y,z reference axis measured from the X,Y,Z reference
- $\dot{\Omega}$ = angular acceleration of x,y,z reference axis measured from the X,Y,Z reference
- $\mathbf{r}_{A/B}$ = relative position of "A" with respect to "B"
- $\mathbf{v}_{A/B}$ = relative velocity of "A" with respect to "B"
- $\mathbf{a}_{A/B}$ = relative acceleration of "A" with respect to "B"

Particle Kinematics

Kinematics is the study of motion without consideration of the mass of, or the forces acting on, a system. For particle motion, let $\mathbf{r}(t)$ be the position vector of the particle in an inertial reference frame. The velocity and acceleration of the particle are defined, respectively, as

$$\mathbf{v} = d\mathbf{r}/dt$$

$$\mathbf{a} = d\mathbf{v}/dt$$

where

\mathbf{v} = instantaneous velocity

\mathbf{a} = instantaneous acceleration

t = time

Cartesian Coordinates

$$\mathbf{r} = x\mathbf{i} + y\mathbf{j} + z\mathbf{k}$$

$$\mathbf{v} = \dot{x}\mathbf{i} + \dot{y}\mathbf{j} + \dot{z}\mathbf{k}$$

$$\mathbf{a} = \ddot{x}\mathbf{i} + \ddot{y}\mathbf{j} + \ddot{z}\mathbf{k}$$

where

$$\dot{x} = dx/dt = v_x, \text{ etc.}$$

$$\ddot{x} = d^2x/dt^2 = a_x, \text{ etc.}$$

Radial and Transverse Components for Planar Motion

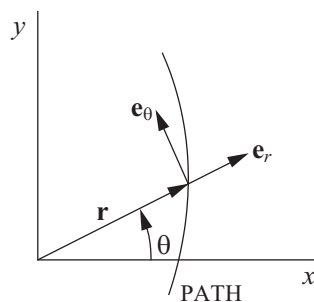

Unit vectors \mathbf{e}_r and \mathbf{e}_θ are, respectively, collinear with and normal to the position vector \mathbf{r} . Thus:

$$\mathbf{r} = r\mathbf{e}_r$$

$$\mathbf{v} = \dot{r}\mathbf{e}_r + r\dot{\theta}\mathbf{e}_\theta$$

$$\mathbf{a} = (\ddot{r} - r\dot{\theta}^2)\mathbf{e}_r + (r\ddot{\theta} + 2\dot{r}\dot{\theta})\mathbf{e}_\theta$$

where

r = radial position coordinate

θ = angle from the x axis to \mathbf{r}

$\dot{r} = dr/dt$, etc.

$\ddot{r} = d^2r/dt^2$, etc.

Particle Rectilinear Motion

<u>Variable a</u>	<u>Constant $a = a_0$</u>
$a = \frac{dv}{dt}$	$v = v_0 + a_0t$
$v = \frac{ds}{dt}$	$s = s_0 + v_0t + \frac{1}{2} a_0t^2$
$a ds = v dv$	$s = s_0 + \frac{1}{2}(v_0 + v)t$
	$v^2 = v_0^2 + 2a_0(s - s_0)$

Particle Curvilinear Motion

<u>x, y, z Coordinates</u>	<u>r, θ, z Coordinates</u>
$v_x = \dot{x} \quad a_x = \ddot{x}$	$v_r = \dot{r} \quad a_r = \ddot{r} - r\dot{\theta}^2$
$v_y = \dot{y} \quad a_y = \ddot{y}$	$v_\theta = r\dot{\theta} \quad a_\theta = r\ddot{\theta} + 2\dot{r}\dot{\theta}$
$v_z = \dot{z} \quad a_z = \ddot{z}$	$v_z = \dot{z} \quad a_z = \ddot{z}$

n, t, b Coordinates

$v = \dot{s}$	$a_t = \dot{v} = \frac{dv}{dt} = v \frac{dv}{ds}$
$a_n = \frac{v^2}{\rho}$	$\rho = \frac{[1 + (dy/dx)^2]^{3/2}}{ d^2y/dx^2 }$

Relative Motion

$$\mathbf{r}_A = \mathbf{r}_B + \mathbf{r}_{A/B} \quad \mathbf{v}_A = \mathbf{v}_B + \mathbf{v}_{A/B} \quad \mathbf{a}_A = \mathbf{a}_B + \mathbf{a}_{A/B}$$

Translating Axes x - y

The equations that relate the absolute and relative position, velocity, and acceleration vectors of two particles A and B , in plane motion, and separated at a constant distance, may be written as

$$\mathbf{r}_A = \mathbf{r}_B + \mathbf{r}_{A/B}$$

$$\mathbf{v}_A = \mathbf{v}_B + \boldsymbol{\omega} \times \mathbf{r}_{A/B} = \mathbf{v}_B + \mathbf{v}_{A/B}$$

$$\mathbf{a}_A = \mathbf{a}_B + \boldsymbol{\alpha} \times \mathbf{r}_{A/B} + \boldsymbol{\omega} \times (\boldsymbol{\omega} \times \mathbf{r}_{A/B}) = \mathbf{a}_B + \mathbf{a}_{A/B}$$

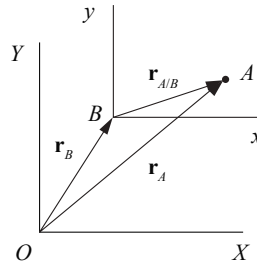

where ω and α are the absolute angular velocity and absolute angular acceleration of the relative position vector $\mathbf{r}_{A/B}$ of constant length, respectively.

Plane Circular Motion

A special case of radial and transverse components is for constant radius rotation about the origin, or plane circular motion.

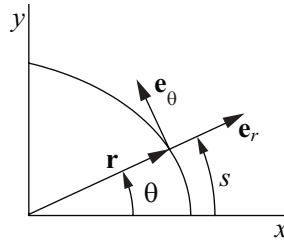

Here the vector quantities are defined as

$$\mathbf{r} = r\mathbf{e}_r$$

$$\mathbf{v} = r\omega\mathbf{e}_\theta$$

$$\mathbf{a} = (-r\omega^2)\mathbf{e}_r + r\alpha\mathbf{e}_\theta$$

where

r = radius of the circle

θ = angle from the x axis to \mathbf{r}

The values of the angular velocity and acceleration, respectively, are defined as

$$\omega = \dot{\theta}$$

$$\alpha = \dot{\omega} = \ddot{\theta}$$

Arc length, transverse velocity, and transverse acceleration, respectively, are

$$s = r\theta$$

$$v_\theta = r\omega$$

$$a_\theta = r\alpha$$

The radial acceleration is given by

$$a_r = -r\omega^2 \text{ (towards the center of the circle)}$$

Normal and Tangential Components

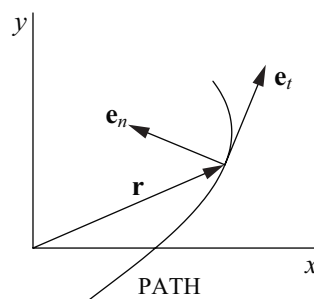

Unit vectors \mathbf{e}_t and \mathbf{e}_n are, respectively, tangent and normal to the path with \mathbf{e}_n pointing to the center of curvature. Thus

$$\mathbf{v} = v(t)\mathbf{e}_t$$

$$\mathbf{a} = a(t)\mathbf{e}_t + (v_t^2/\rho)\mathbf{e}_n$$

where

ρ = instantaneous radius of curvature

Constant Acceleration

The equations for the velocity and displacement when acceleration is a constant are given as

$$a(t) = a_0$$

$$v(t) = a_0(t - t_0) + v_0$$

$$s(t) = a_0(t - t_0)^2/2 + v_0(t - t_0) + s_0$$

where

s = displacement at time t , along the line of travel

s_0 = displacement at time t_0

v = velocity along the direction of travel

v_0 = velocity at time t_0

a_0 = constant acceleration

t = time

t_0 = some initial time

For a free-falling body, $a_0 = g$ (downward towards earth).

An additional equation for velocity as a function of position may be written as

$$v^2 = v_0^2 + 2a_0(s - s_0)$$

For constant angular acceleration, the equations for angular velocity and displacement are

$$\alpha(t) = \alpha_0$$

$$\omega(t) = \alpha_0(t - t_0) + \omega_0$$

$$\theta(t) = \alpha_0(t - t_0)^2/2 + \omega_0(t - t_0) + \theta_0$$

where

θ = angular displacement

θ_0 = angular displacement at time t_0

ω = angular velocity

ω_0 = angular velocity at time t_0

α_0 = constant angular acceleration

t = time

t_0 = some initial time

An additional equation for angular velocity as a function of angular position may be written as

$$\omega^2 = \omega_0^2 + 2\alpha_0(\theta - \theta_0)$$

Projectile Motion

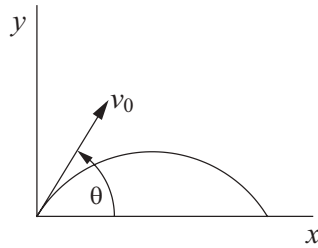

The equations for common projectile motion may be obtained from the constant acceleration equations as

$$a_x = 0$$

$$v_x = v_0 \cos(\theta)$$

$$x = v_0 \cos(\theta)t + x_0$$

$$a_y = -g$$

$$v_y = -gt + v_0 \sin(\theta)$$

$$y = -gt^2/2 + v_0 \sin(\theta)t + y_0$$

Non-constant Acceleration

When non-constant acceleration, $a(t)$, is considered, the equations for the velocity and displacement may be obtained from

$$v(t) = \int_{t_0}^t a(\tau) d\tau + v_{t_0}$$

$$s(t) = \int_{t_0}^t v(\tau) d\tau + s_{t_0}$$

For variable angular acceleration

$$\omega(t) = \int_{t_0}^t \alpha(\tau) d\tau + \omega_{t_0}$$

$$\theta(t) = \int_{t_0}^t \omega(\tau) d\tau + \theta_{t_0}$$

where τ is the variable of integration

Concept of Weight

$$W = mg$$

where

$$W = \text{weight (N or lbf)}$$

$$m = \text{mass (kg or lbf-sec}^2/\text{ft)}$$

$$g = \text{local acceleration of gravity (m/s}^2 \text{ or ft/sec}^2\text{)}$$

Particle Kinetics

Newton's second law for a particle is

$$\Sigma \mathbf{F} = d(m\mathbf{v})/dt$$

where

$\Sigma \mathbf{F}$ = sum of the applied forces acting on the particle

m = mass of the particle

\mathbf{v} = velocity of the particle

For constant mass,

$$\Sigma \mathbf{F} = m d\mathbf{v}/dt = m\mathbf{a}$$

One-Dimensional Motion of a Particle (Constant Mass)

When motion exists only in a single dimension then, without loss of generality, it may be assumed to be in the x direction, and

$$a_x = F_x/m$$

where F_x = the resultant of the applied forces, which in general can depend on t , x , and v_x .

If F_x only depends on t , then

$$a_x(t) = F_x(t)/m$$

$$v_x(t) = \int_{t_0}^t a_x(\tau) d\tau + v_{xt_0}$$

$$x(t) = \int_{t_0}^t v_x(\tau) d\tau + x_{t_0}$$

where τ is the variable of integration.

If the force is constant (i.e., independent of time, displacement, and velocity) then

$$a_x = F_x/m$$

$$v_x = a_x(t - t_0) + v_{xt_0}$$

$$x = a_x(t - t_0)^2/2 + v_{xt_0}(t - t_0) + x_{t_0}$$

Normal and Tangential Kinetics for Planar Problems

When working with normal and tangential directions, the scalar equations may be written as

$$\Sigma F_t = ma_t = mdv_t/dt$$

$$\Sigma F_n = ma_n = m(v_t^2/\rho)$$

Principle of Work and Energy

If T_i and V_i are, respectively, the kinetic and potential energy of a particle at state i , then for conservative systems (no energy dissipation or gain), the law of conservation of energy is

$$T_2 + V_2 = T_1 + V_1$$

If nonconservative forces are present, then the work done by these forces must be accounted for. Hence

$$T_2 + V_2 = T_1 + V_1 + U_{1 \rightarrow 2}, \text{ where}$$

$U_{1 \rightarrow 2}$ = the work done by the nonconservative forces in moving between state 1 and state 2. Care must be exercised during computations to correctly compute the algebraic sign of the work term. If the forces serve to increase the energy of the system, $U_{1 \rightarrow 2}$ is positive. If the forces, such as friction, serve to dissipate energy, $U_{1 \rightarrow 2}$ is negative.

Kinetic Energy

<i>Particle</i>	$T = \frac{1}{2}mv^2$
<i>Rigid Body</i> <i>(Plane Motion)</i>	$T = \frac{1}{2}mv_c^2 + \frac{1}{2}I_c \omega^2$

subscript c represents the center of mass

Potential Energy

$$V = V_g + V_e, \text{ where } V_g = Wy, V_e = 1/2 ks^2$$

The work done by an external agent in the presence of a conservative field is termed the change in potential energy.

Potential Energy in Gravity Field

$$V_g = mgh$$

where h = the elevation above some specified datum.

Elastic Potential Energy

For a linear elastic spring with modulus, stiffness, or spring constant, k , the force in the spring is

$$F_s = k s$$

where s = the change in length of the spring from the undeformed length of the spring.

In changing the deformation in the spring from position s_1 to s_2 , the change in the potential energy stored in the spring is

$$V_2 - V_1 = k(s_2^2 - s_1^2)/2$$

Work

Work U is defined as

$$\underline{U} = \int \mathbf{F} \cdot d\mathbf{r}$$

Variable force $U_F = \int F \cos \theta ds$

Constant force $U_F = (F_c \cos \theta) \Delta s$

Weight $U_w = -W \Delta y$

Spring $U_s = -\left(\frac{1}{2}ks_2^2 - \frac{1}{2}ks_1^2\right)$

Couple moment $U_M = M \Delta \theta$

Power and Efficiency

$$P = \frac{dU}{dt} = \mathbf{F} \cdot \mathbf{v} \quad \epsilon = \frac{P_{\text{out}}}{P_{\text{in}}} = \frac{U_{\text{out}}}{U_{\text{in}}}$$

Adapted from Hibbeler, R.C., *Engineering Mechanics*, 10th ed., Prentice Hall, 2003.

Impulse and Momentum

Linear Momentum

Assuming constant mass, the equation of motion of a particle may be written as

$$m d\mathbf{v}/dt = \mathbf{F}$$

$$m d\mathbf{v} = \mathbf{F} dt$$

For a system of particles, by integrating and summing over the number of particles, this may be expanded to

$$\Sigma m_i (\mathbf{v}_i)_{t_2} = \Sigma m_i (\mathbf{v}_i)_{t_1} + \Sigma \int_{t_1}^{t_2} \mathbf{F}_i dt$$

The term on the left side of the equation is the linear momentum of a system of particles at time t_2 . The first term on the right side of the equation is the linear momentum of a system of particles at time t_1 . The second term on the right side of the equation is the impulse of the force \mathbf{F} from time t_1 to t_2 . It should be noted that the above equation is a vector equation. Component scalar equations may be obtained by considering the momentum and force in a set of orthogonal directions.

Angular Momentum or Moment of Momentum

The angular momentum or the moment of momentum about point 0 for a particle is defined as

$$\mathbf{H}_0 = \mathbf{r} \times m\mathbf{v}, \text{ or}$$

$$\mathbf{H}_0 = I_0 \omega$$

Taking the time derivative of the above, the equation of motion may be written as

$$\dot{\mathbf{H}}_0 = d(I_0 \omega)/dt = \mathbf{M}_0$$

where \mathbf{M}_0 is the moment applied to the particle. Now by integrating and summing over a system of any number of particles, this may be expanded to

$$\Sigma (\mathbf{H}_{0i})_{t_2} = \Sigma (\mathbf{H}_{0i})_{t_1} + \Sigma \int_{t_1}^{t_2} \mathbf{M}_{0i} dt$$

The term on the left side of the equation is the angular momentum of a system of particles at time t_2 . The first term on the right side of the equation is the angular momentum of a system of particles at time t_1 . The second term on the right side of the equation is the angular impulse of the moment \mathbf{M}_0 from time t_1 to t_2 .

Impact

During an impact, momentum is conserved while energy may or may not be conserved. For direct central impact with no external forces

$$m_1 v_1 + m_2 v_2 = m_1 v'_1 + m_2 v'_2$$

where

$$m_1, m_2 = \text{masses of the two bodies}$$

$$v_1, v_2 = \text{velocities of the bodies just before impact}$$

$$v'_1, v'_2 = \text{velocities of the bodies just after impact}$$

For impacts, the relative velocity expression is

$$e = \frac{(v'_2)_n - (v'_1)_n}{(v_1)_n - (v_2)_n}$$

where

$$e = \text{coefficient of restitution}$$

$$(v_i)_n = \text{velocity normal to the plane of impact just **before** impact}$$

$$(v'_i)_n = \text{velocity normal to the plane of impact just **after** impact}$$

The value of e is such that

$$0 \leq e \leq 1, \text{ with limiting values}$$

$e = 1$, perfectly elastic (energy conserved)

$e = 0$, perfectly plastic (no rebound)

Knowing the value of e , the velocities after the impact are given as

$$(v'_1)_n = \frac{m_2 (v_2)_n (1 + e) + (m_1 - em_2)(v_1)_n}{m_1 + m_2}$$

$$(v'_2)_n = \frac{m_1 (v_1)_n (1 + e) - (em_1 - m_2)(v_2)_n}{m_1 + m_2}$$

Friction

The Laws of Friction are

1. The total friction force F that can be developed is independent of the magnitude of the area of contact.
2. The total friction force F that can be developed is proportional to the normal force N .
3. For low velocities of sliding, the total frictional force that can be developed is practically independent of the sliding velocity, although experiments show that the force F necessary to initiate slip is greater than that necessary to maintain the motion.

The formula expressing the Laws of Friction is

$$F \leq \mu N$$

where μ = the coefficient of friction.

In general

$$F < \mu_s N, \text{ no slip occurring}$$

$$F = \mu_s N, \text{ at the point of impending slip}$$

$$F = \mu_k N, \text{ when slip is occurring}$$

Here,

μ_s = coefficient of static friction

μ_k = coefficient of kinetic friction

Plane Motion of a Rigid Body

Kinematics of a Rigid Body

Rigid Body Rotation

For rigid body rotation θ

$$\omega = d\theta/dt$$

$$\alpha = d\omega/dt$$

$$\alpha d\theta = \omega d\omega$$

Instantaneous Center of Rotation (Instant Centers)

An instantaneous center of rotation (instant center) is a point, common to two bodies, at which each has the same velocity (magnitude and direction) at a given instant. It is also a point in space about which a body rotates, instantaneously.

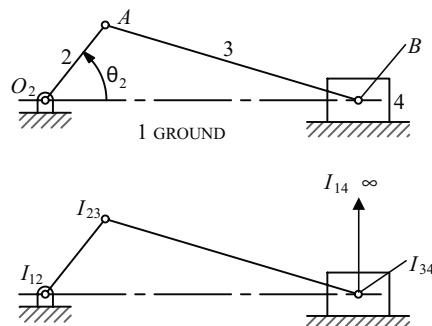

The figure shows a fourbar slider-crank. Link 2 (the crank) rotates about the fixed center, O_2 . Link 3 couples the crank to the slider (link 4), which slides against ground (link 1). Using the definition of an instant center (IC), we see that the pins at O_2 , A , and B are ICs that are designated I_{12} , I_{23} , and I_{34} . The easily observable IC is I_{14} , which is located at infinity with its direction perpendicular to the interface between links 1 and 4 (the direction of sliding). To locate the remaining two ICs (for a fourbar) we must make use of Kennedy's rule.

Kennedy's Rule: When three bodies move relative to one another they have three instantaneous centers, all of which lie on the same straight line.

To apply this rule to the slider-crank mechanism, consider links 1, 2, and 3 whose ICs are I_{12} , I_{23} , and I_{13} , all of which lie on a straight line. Consider also links 1, 3, and 4 whose ICs are I_{13} , I_{34} , and I_{14} , all of which lie on a straight line. Extending the line through I_{12} and I_{23} and the line through I_{34} and I_{14} to their intersection locates I_{13} , which is common to the two groups of links that were considered.

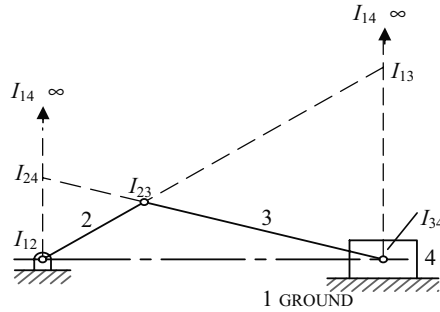

Similarly, if body groups 1, 2, 4 and 2, 3, 4 are considered, a line drawn through known ICs I_{12} and I_{14} to the intersection of a line drawn through known ICs I_{23} and I_{34} locates I_{24} .

The number of ICs , c , for a given mechanism is related to the number of links, n , by

$$c = \frac{n(n - 1)}{2}$$

Kinetics of a Rigid Body

In general, Newton's second law for a rigid body, with constant mass and mass moment of inertia, in plane motion may be written in vector form as

$$\Sigma \mathbf{F} = m \mathbf{a}_c$$

$$\Sigma \mathbf{M}_c = I_c \boldsymbol{\alpha}$$

$$\Sigma \mathbf{M}_p = I_c \boldsymbol{\alpha} + \boldsymbol{\rho}_{pc} \times m \mathbf{a}_c$$

where \mathbf{F} are forces and \mathbf{a}_c is the acceleration of the body's mass center both in the plane of motion, \mathbf{M}_c are moments and $\boldsymbol{\alpha}$ is the angular acceleration both about an axis normal to the plane of motion, I_c is the mass moment of inertia about the normal axis through the mass center, and $\boldsymbol{\rho}_{pc}$ is a vector from point p to point c .

Mass Moment of Inertia

$$I = \int r^2 dm$$

Parallel-Axis Theorem $I = I_c + md^2$

Radius of Gyration $r_m = \sqrt{\frac{I}{m}}$

Equations of Motion

$$\begin{array}{l|l}
 \text{Rigid Body} & \Sigma F_x = m(a_c)_x \\
 \text{(Plane Motion)} & \Sigma F_y = m(a_c)_y \\
 & \Sigma M_c = I_c \alpha \text{ or } \Sigma M_p = \Sigma (M_k)_p
 \end{array}$$

Subscript c indicates center of mass.

Mass Moment of Inertia

The definitions for the mass moments of inertia are

$$I_x = \int (y^2 + z^2) dm$$

$$I_y = \int (x^2 + z^2) dm$$

$$I_z = \int (x^2 + y^2) dm$$

A table listing moment of inertia formulas for some standard shapes is at the end of this section.

Parallel-Axis Theorem

The mass moments of inertia may be calculated about any axis through the application of the above definitions. However, once the moments of inertia have been determined about an axis passing through a body's mass center, it may be transformed to another parallel axis. The transformation equation is

$$I_{\text{new}} = I_c + md^2$$

where

I_{new} = mass moment of inertia about any specified axis

I_c = mass moment of inertia about an axis that is parallel to the above specified axis but passes through the body's mass center

m = mass of the body

d = normal distance from the body's mass center to the above-specified axis

Mass Radius of Gyration

The mass radius of gyration is defined as

$$r_m = \sqrt{I/m}$$

Without loss of generality, the body may be assumed to be in the x - y plane. The scalar equations of motion may then be written as

$$\Sigma F_x = ma_{xc}$$

$$\Sigma F_y = ma_{yc}$$

$$\Sigma M_{zc} = I_{zc} \alpha$$

where zc indicates the z axis passing through the body's mass center, a_{xc} and a_{yc} are the acceleration of the body's mass center in the x and y directions, respectively, and α is the angular acceleration of the body about the z axis.

Rigid Body Motion About a Fixed Axis

<u>Variable α</u>	<u>Constant $\alpha = \alpha_0$</u>
$\alpha = \frac{d\omega}{dt}$	$\omega = \omega_0 + \alpha_0 t$
$\omega = \frac{d\theta}{dt}$	$\theta = \theta_0 + \omega_0 t + \frac{1}{2} \alpha_0 t^2$
$\omega d\omega = \alpha d\theta$	$\omega^2 = \omega_0^2 + 2\alpha_0(\theta - \theta_0)$

For rotation about some arbitrary fixed axis q

$$\Sigma M_q = I_q \alpha$$

If the applied moment acting about the fixed axis is constant then integrating with respect to time, from $t = 0$ yields

$$\begin{aligned} \alpha &= M_q / I_q \\ \omega &= \omega_0 + \alpha t \\ \theta &= \theta_0 + \omega_0 t + \alpha t^2 / 2 \end{aligned}$$

where ω_0 and θ_0 are the values of angular velocity and angular displacement at time $t = 0$, respectively.

The change in kinetic energy is the work done in accelerating the rigid body from ω_0 to ω

$$I_q \omega^2 / 2 = I_q \omega_0^2 / 2 + \int_{\theta_0}^{\theta} M_q d\theta$$

Kinetic Energy

In general the kinetic energy for a rigid body may be written as

$$T = mv^2/2 + I_c \omega^2/2$$

For motion in the xy plane this reduces to

$$T = m(v_{cx}^2 + v_{cy}^2)/2 + I_c \omega^2/2$$

For motion about an instant center,

$$T = I_{IC} \omega^2/2$$

Principle of Angular Impulse and Momentum

Rigid Body (Plane Motion)	$(\mathbf{H}_c)_1 + \Sigma \int \mathbf{M}_c dt = (\mathbf{H}_c)_2$ where $\mathbf{H}_c = I_c \omega$ $(\mathbf{H}_o)_1 + \Sigma \int \mathbf{M}_o dt = (\mathbf{H}_o)_2$ where $\mathbf{H}_o = I_o \omega$
------------------------------	--

Subscript c indicates center of mass.

Conservation of Angular Momentum

$$\Sigma(\text{ syst. } \mathbf{H})_1 = \Sigma(\text{ syst. } \mathbf{H})_2$$

Free and Forced Vibration

A single degree-of-freedom vibration system, containing a mass m , a spring k , a viscous damper c , and an external applied force F can be diagrammed as shown:

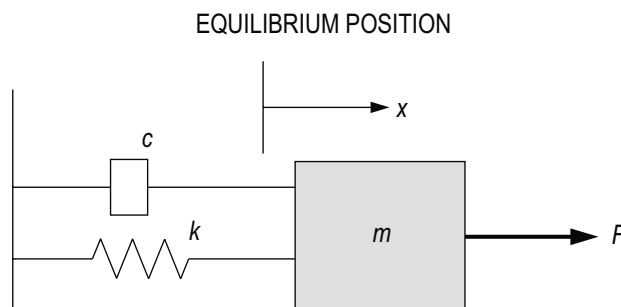

The equation of motion for the displacement of x is:

$$m\ddot{x} = -kx - c\dot{x} + F$$

or in terms of x ,

$$m\ddot{x} + c\dot{x} + kx = F$$

One can define

$$\omega_n = \sqrt{\frac{k}{m}}$$

$$\zeta = \frac{c}{2\sqrt{km}}$$

$$K = \frac{1}{k}$$

Then:

$$\frac{1}{\omega_n^2}\ddot{x} + \frac{2\zeta}{\omega_n}\dot{x} + x = KF$$

If the externally applied force is 0, this is a free vibration, and the motion of x is solved as the solution to a homogeneous ordinary differential equation.

In a forced vibration system, the externally applied force F is typically periodic (for example, $F = F_0 \sin \omega t$). The solution is the sum of the homogeneous solution and a particular solution.

For forced vibrations, one is typically interested in the steady state behavior (i.e. a long time after the system has started), which is the particular solution.

For $F = F_0 \sin \omega t$, the particular solution is:

$$x(t) = X_0 \sin(\omega t + \phi)$$

where

$$X_0 = \frac{KF_0}{\sqrt{\left(1 - \frac{\omega^2}{\omega_n^2}\right)^2 + \left(\frac{2\zeta\omega}{\omega_n}\right)^2}}$$

$$\phi = \tan^{-1} \frac{\frac{2\zeta\omega}{\omega_n}}{1 - \frac{\omega^2}{\omega_n^2}}$$

The following figures provide illustrative plots of relative amplitude and phase, depending on ω and ω_n .

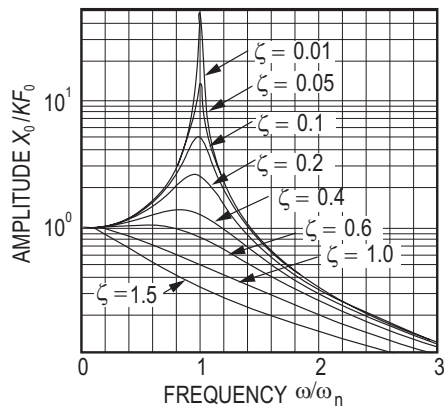

(a)

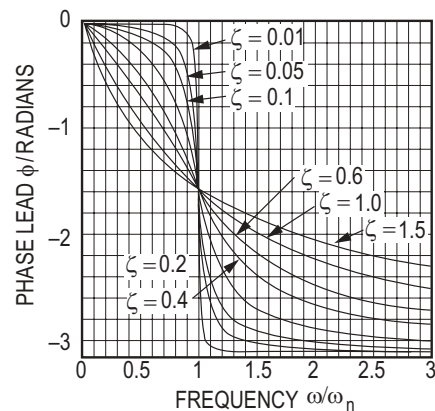

(b)

Steady state vibration of a force spring-mass system (a) amplitude (b) phase.

Torsional Vibration

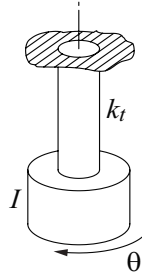

For torsional free vibrations it may be shown that the differential equation of motion is

$$\ddot{\theta} + (k_t/I)\theta = 0$$

where

θ = angular displacement of the system

k_t = torsional stiffness of the massless rod

I = mass moment of inertia of the end mass

The solution may now be written in terms of the initial conditions $\theta(0) = \theta_0$ and $\dot{\theta}(0) = \dot{\theta}_0$ as

$$\theta(t) = \theta_0 \cos(\omega_n t) + (\dot{\theta}_0/\omega_n) \sin(\omega_n t)$$

where the undamped natural circular frequency is given by

$$\omega_n = \sqrt{k_t/I}$$

The torsional stiffness of a solid round rod with associated polar moment-of-inertia J , length L , and shear modulus of elasticity G is given by

$$k_t = GJ/L$$

Thus the undamped circular natural frequency for a system with a solid round supporting rod may be written as

$$\omega_n = \sqrt{GJ/IL}$$

Similar to the linear vibration problem, the undamped natural period may be written as

$$\tau_n = 2\pi/\omega_n = \frac{2\pi}{\sqrt{k_t/I}} = \frac{2\pi}{\sqrt{GJ/IL}}$$

Dynamics

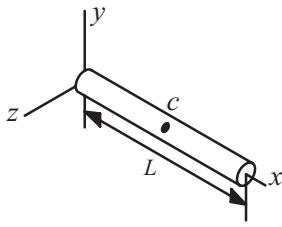
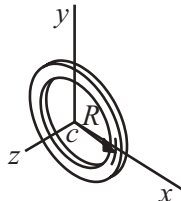
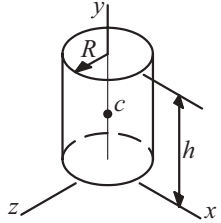
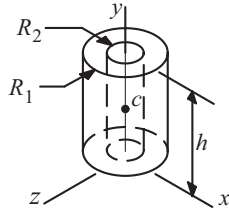
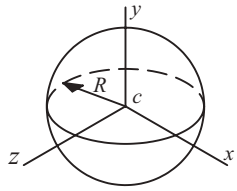
Figure	Mass & Centroid	Mass Moment of Inertia	(Radius of Gyration) ²
	$M = \rho LA$ $x_c = L/2$ $y_c = 0$ $z_c = 0$ $A =$ cross-sectional area of rod $\rho =$ mass/vol.	$I_x = I_{x_c} = 0$ $I_{y_c} = I_{z_c} = ML^2/12$ $I_y = I_z = ML^2/3$	$r_{x_c}^2 = r_{x_c}^2 = 0$ $r_{y_c}^2 = r_{z_c}^2 = L^2/12$ $r_y^2 = r_z^2 = L^2/3$
	$M = \rho_s A$ $x_c = R =$ mean radius $y_c = R =$ mean radius $z_c = 0$ $A =$ cross-sectional area of ring $\rho =$ mass/area	$I_{x_c} = I_{y_c} = MR^2/2$ $I_{z_c} = MR^2$ $I_x = I_y = 3MR^2/2$ $I_z = 3MR^2$	$r_{x_c}^2 = r_{y_c}^2 = R^2/2$ $r_{z_c}^2 = R^2$ $r_x^2 = r_y^2 = 3R^2/2$ $r_z^2 = 3R^2$
	$M = \pi R^2 \rho h$ $x_c = 0$ $y_c = h/2$ $z_c = 0$ $\rho =$ mass/vol.	$I_{x_c} = I_{z_c} = M(3R^2 + h^2)/12$ $I_{y_c} = I_y = MR^2/2$ $I_x = I_z = M(3R^2 + 4h^2)/12$	$r_{x_c}^2 = r_{z_c}^2 = (3R^2 + h^2)/12$ $r_{y_c}^2 = r_y^2 = R^2/2$ $r_x^2 = r_z^2 = (3R^2 + 4h^2)/12$
	$M = \pi(R_1^2 - R_2^2)\rho h$ $x_c = 0$ $y_c = h/2$ $z_c = 0$ $\rho =$ mass/vol.	$I_{x_c} = I_{z_c} = M(3R_1^2 + 3R_2^2 + h^2)/12$ $I_{y_c} = I_y = M(R_1^2 + R_2^2)/2$ $I_x = I_z = M(3R_1^2 + 3R_2^2 + 4h^2)/12$	$r_{x_c}^2 = r_{z_c}^2 = (3R_1^2 + 3R_2^2 + h^2)/12$ $r_{y_c}^2 = r_y^2 = (R_1^2 + R_2^2)/2$ $r_x^2 = r_z^2 = (3R_1^2 + 3R_2^2 + 4h^2)/12$
	$M = \frac{4}{3}\pi R^3 \rho$ $x_c = 0$ $y_c = 0$ $z_c = 0$ $\rho =$ mass/vol.	$I_{x_c} = I_x = 2MR^2/5$ $I_{y_c} = I_y = 2MR^2/5$ $I_{z_c} = I_z = 2MR^2/5$	$r_{x_c}^2 = r_x^2 = 2R^2/5$ $r_{y_c}^2 = r_y^2 = 2R^2/5$ $r_{z_c}^2 = r_z^2 = 2R^2/5$

Housner, George W., and Donald E. Hudson, *Applied Mechanics Dynamics*, D. Van Nostrand Company, Inc., Princeton, NJ, 1959. Table reprinted by permission of G.W. Housner & D.E. Hudson.

Dynamics

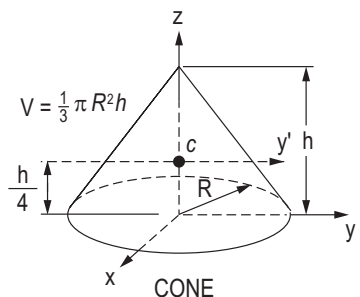
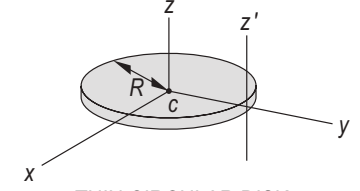
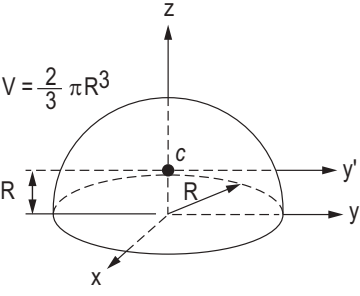
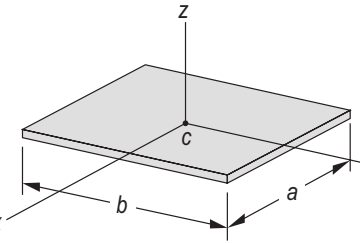
Figure	Mass & Centroid	Mass Moment of Inertia	(Radius of Gyration) ²
 <p>CONE</p>	$M = \frac{1}{3} \pi R^2 h \rho$ $x_c = y_c = 0$ $z_c = \frac{h}{4}$ $\rho = \text{mass/vol.}$	$I_{x'x'} = I_{y'y'} = \frac{3}{80} M (4R^2 + h^2)$ $I_{zz} = \frac{3}{10} MR^2$ $I_{yy} = I_{xx} = \frac{1}{20} M (3R^2 + 2h^2)$	$r_{xx}^2 = r_{yy}^2 = \frac{3}{80} (4R^2 + h^2)$ $r_{zz}^2 = \frac{3}{10} R^2$
 <p>THIN CIRCULAR DISK</p>	$M = \pi R^2 \rho_s$ $x_c = y_c = z_c = 0$ $\rho_s = \text{mass/area}$	$I_{xx} = I_{yy} = \frac{1}{4} MR^2$ $I_{zz} = \frac{1}{2} MR^2$ $I_{z'z'} = \frac{3}{2} MR^2$	$r_{xx}^2 = r_{yy}^2 = \frac{1}{4} R^2$ $r_{zz}^2 = \frac{1}{2} R^2$ $r_{z'z'}^2 = \frac{3}{2} R^2$
 <p>HEMISPHERE</p>	$M = \frac{2}{3} \pi R^3 \rho$ $x_c = y_c = 0$ $z_c = \frac{3}{8} R$ $\rho = \text{mass/vol.}$	$I_{x'x'} = I_{y'y'} = \frac{83}{320} MR^2$ $I_{zz} = \frac{2}{5} MR^2$	$r_{xx}^2 = r_{yy}^2 = 0.259 R^2$ $r_{zz}^2 = \frac{2}{5} R^2$
 <p>THIN PLATE</p>	$M = ab \rho_s$ $x_c = y_c = z_c = 0$ $\rho_s = \text{mass/area}$	$I_{xx} = \frac{1}{12} Mb^2$ $I_{yy} = \frac{1}{12} Ma^2$ $I_{zz} = \frac{1}{12} M (a^2 + b^2)$	$r_{xx}^2 = \frac{1}{12} b^2$ $r_{yy}^2 = \frac{1}{12} a^2$ $r_{zz}^2 = \frac{1}{12} (a^2 + b^2)$

Housner, George W., and Donald E. Hudson, *Applied Mechanics Dynamics*, D. Van Nostrand Company, Inc., Princeton, NJ, 1959. Table reprinted by permission of G.W. Housner & D.E. Hudson.

Mechanics of Materials

Uniaxial Stress-Strain

Stress-Strain Curve for Mild Steel

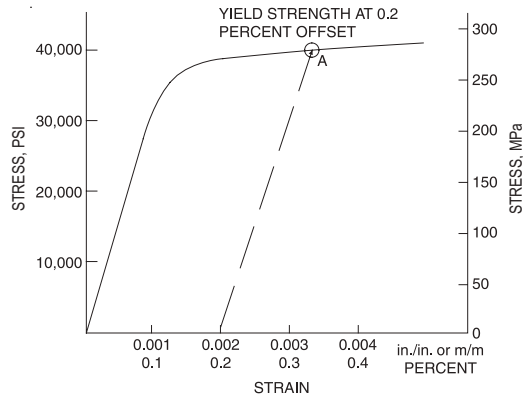

Flinn, Richard A., and Paul K. Trojan, *Engineering Materials & Their Applications*, 4th ed., Houghton Mifflin Co., Boston, 1990.

The slope of the linear portion of the curve equals the modulus of elasticity.

Definitions

Engineering Strain

$$\varepsilon = \Delta L / L_o$$

where

ε = engineering strain (units per unit)

ΔL = change in length (units) of member

L_o = original length (units) of member

Percent Elongation

$$\% \text{ Elongation} = \left(\frac{\Delta L}{L_o} \right) \times 100$$

Percent Reduction in Area (RA)

The % reduction in area from initial area, A_i , to final area, A_f , is:

$$\% RA = \left(\frac{A_i - A_f}{A_i} \right) \times 100$$

Shear Stress-Strain

$$\gamma = \tau / G$$

where

γ = shear strain

τ = shear stress

G = shear modulus (constant in linear torsion-rotation relationship)

$$G = \frac{E}{2(1 + \nu)}$$

where

$$E = \text{modulus of elasticity (Young's modulus)}$$

$$\nu = \text{Poisson's ratio}$$

$$= -(\text{lateral strain})/(\text{longitudinal strain})$$

Bulk (Volume) Modulus of Elasticity

$$K = \frac{E}{3(1 - 2\nu)}$$

where

$$K = \text{bulk modulus}$$

$$E = \text{modulus of elasticity}$$

$$\nu = \text{Poisson's ratio}$$

Uniaxial Loading and Deformation

$$\sigma = P/A$$

where

$$\sigma = \text{stress on the cross section}$$

$$P = \text{loading}$$

$$A = \text{cross-sectional area}$$

$$\varepsilon = \delta/L$$

where

$$\delta = \text{elastic longitudinal deformation}$$

$$L = \text{length of member}$$

$$E = \sigma/\varepsilon = \frac{P/A}{\delta/L}$$

$$\delta = \frac{PL}{AE}$$

True stress is load divided by actual cross-sectional area whereas engineering stress is load divided by the initial area.

Thermal Deformations

$$\delta_t = \alpha L(T - T_o)$$

where

$$\delta_t = \text{deformation caused by a change in temperature}$$

$$\alpha = \text{temperature coefficient of expansion}$$

$$L = \text{length of member}$$

$$T = \text{final temperature}$$

$$T_o = \text{initial temperature}$$

Cylindrical Pressure Vessel

For internal pressure only, the stresses at the inside wall are:

$$\sigma_t = P_i \frac{r_o^2 + r_i^2}{r_o^2 - r_i^2} \quad \text{and} \quad \sigma_r = -P_i$$

For external pressure only, the stresses at the outside wall are:

$$\sigma_t = -P_o \frac{r_o^2 + r_i^2}{r_o^2 - r_i^2} \quad \text{and} \quad \sigma_r = -P_o$$

where

σ_t = tangential (hoop) stress

σ_r = radial stress

P_i = internal pressure

P_o = external pressure

r_i = inside radius

r_o = outside radius

For vessels with end caps, the axial stress is:

$$\sigma_a = P_i \frac{r_i^2}{r_o^2 - r_i^2}$$

where σ_t , σ_r , and σ_a are principal stresses.

When the thickness of the cylinder wall is about one-tenth or less of inside radius, the cylinder can be considered as thin-walled. In which case, the internal pressure is resisted by the hoop stress and the axial stress.

$$\sigma_t = \frac{P_i r}{t} \quad \text{and} \quad \sigma_a = \frac{P_i r}{2t}$$

where

t = wall thickness

$$r = \frac{r_i + r_o}{2}$$

Stress and Strain

Principal Stresses

For the special case of a *two-dimensional* stress state, the equations for principal stress reduce to

$$\sigma_a, \sigma_b = \frac{\sigma_x + \sigma_y}{2} \pm \sqrt{\left(\frac{\sigma_x - \sigma_y}{2}\right)^2 + \tau_{xy}^2}$$

$$\sigma_c = 0$$

The two nonzero values calculated from this equation are temporarily labeled σ_a and σ_b and the third value σ_c is always zero in this case. Depending on their values, the three roots are then labeled according to the convention:

algebraically largest = σ_1 , *algebraically smallest* = σ_3 , *other* = σ_2 . A typical 2D stress element is shown below with all indicated components shown in their positive sense.

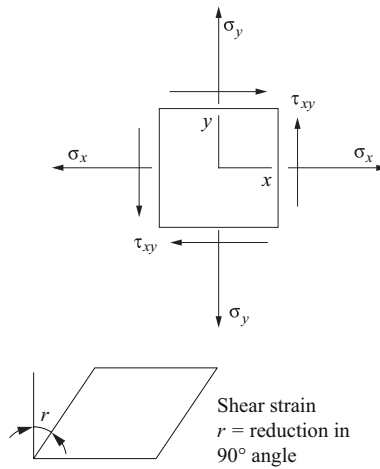

Crandall, S.H., and N.C. Dahl, *An Introduction to Mechanics of Solids*, McGraw-Hill, New York, 1959.

Mohr's Circle – Stress, 2D

To construct a Mohr's circle, the following sign conventions are used.

1. Tensile normal stress components are plotted on the horizontal axis and are considered positive. Compressive normal stress components are negative.
2. For constructing Mohr's circle only, shearing stresses are plotted above the normal stress axis when the pair of shearing stresses, acting on opposite and parallel faces of an element, forms a clockwise couple. Shearing stresses are plotted below the normal axis when the shear stresses form a counterclockwise couple.

The circle drawn with the center on the normal stress (horizontal) axis with center, C , and radius, R , where

$$C = \frac{\sigma_x + \sigma_y}{2}, \quad R = \sqrt{\left(\frac{\sigma_x - \sigma_y}{2}\right)^2 + \tau_{xy}^2}$$

The two nonzero principal stresses are then:

$$\begin{aligned} \sigma_a &= C + R \\ \sigma_b &= C - R \end{aligned}$$

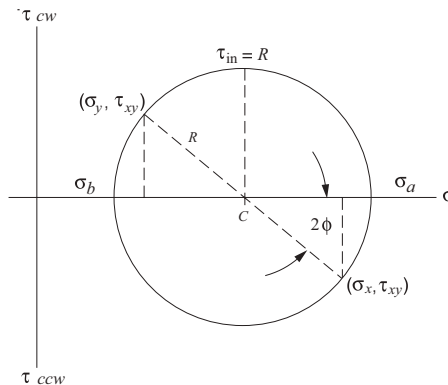

Crandall, S.H., and N.C. Dahl, *An Introduction to Mechanics of Solids*, McGraw-Hill, New York, 1959.

The maximum *inplane* shear stress is $\tau_{in} = R$. However, the maximum shear stress considering three dimensions is always

$$\tau_{max} = \frac{\sigma_1 - \sigma_3}{2}.$$

Hooke's Law

Three-dimensional case:

$$\varepsilon_x = (1/E)[\sigma_x - \nu(\sigma_y + \sigma_z)] \quad \gamma_{xy} = \tau_{xy}/G$$

$$\varepsilon_y = (1/E)[\sigma_y - \nu(\sigma_z + \sigma_x)] \quad \gamma_{yz} = \tau_{yz}/G$$

$$\varepsilon_z = (1/E)[\sigma_z - \nu(\sigma_x + \sigma_y)] \quad \gamma_{zx} = \tau_{zx}/G$$

Plane stress case ($\sigma_z = 0$):

$$\begin{aligned} \varepsilon_x &= (1/E)(\sigma_x - \nu\sigma_y) \\ \varepsilon_y &= (1/E)(\sigma_y - \nu\sigma_x) \\ \varepsilon_z &= -(1/E)(\nu\sigma_x + \nu\sigma_y) \end{aligned} \quad \begin{Bmatrix} \sigma_x \\ \sigma_y \\ \tau_{xy} \end{Bmatrix} = \frac{E}{1-\nu^2} \begin{bmatrix} 1 & \nu & 0 \\ \nu & 1 & 0 \\ 0 & 0 & \frac{1-\nu}{2} \end{bmatrix} \begin{Bmatrix} \varepsilon_x \\ \varepsilon_y \\ \gamma_{xy} \end{Bmatrix}$$

Uniaxial case ($\sigma_y = \sigma_z = 0$):

$$\sigma_x = E\varepsilon_x \text{ or } \sigma = E\varepsilon$$

where

$\varepsilon_x, \varepsilon_y, \varepsilon_z$ = normal strain

$\sigma_x, \sigma_y, \sigma_z$ = normal stress

$\gamma_{xy}, \gamma_{yz}, \gamma_{zx}$ = shear strain

$\tau_{xy}, \tau_{yz}, \tau_{zx}$ = shear stress

E = modulus of elasticity

G = shear modulus

ν = Poisson's ratio

When there is a temperature change from an initial temperature T_i to a final temperature T_f , there are also thermally-induced normal strains. In this case, $\varepsilon_x, \varepsilon_y,$ and ε_z require modification. Thus,

$$\varepsilon_x = \frac{1}{E}[\sigma_x - \nu(\sigma_y + \sigma_z)] + \alpha(T_f - T_i)$$

and similarly for ε_y and ε_z , where α = coefficient of thermal expansion (CTE).

Torsion

Torsion stress in circular solid or thick-walled ($t > 0.1 r$) shafts:

$$\tau = \frac{Tr}{J}$$

where J = polar moment of inertia

Torsional Strain

$$\gamma_{\phi z} = \lim_{\Delta z \rightarrow 0} r(\Delta\phi/\Delta z) = r(d\phi/dz)$$

The shear strain varies in direct proportion to the radius, from zero strain at the center to the greatest strain at the outside of the shaft. $d\phi/dz$ is the twist per unit length or the rate of twist.

$$\tau_{\phi z} = G\gamma_{\phi z} = Gr(d\phi/dz)$$

$$T = G(d\phi/dz) \int_A r^2 dA = GJ(d\phi/dz)$$

$$\phi = \int_0^L \frac{T}{GJ} dz = \frac{TL}{GJ}$$

where

ϕ = total angle (radians) of twist

T = torque

L = length of shaft

T/ϕ gives the *twisting moment per radian of twist*. This is called the *torsional stiffness* and is often denoted by the symbol k or c .

For Hollow, Thin-Walled Shafts

$$\tau = \frac{T}{2A_m t}$$

where

t = thickness of shaft wall

A_m = area of a solid shaft of radius equal to the mean radius of the hollow shaft

Beams

Shearing Force and Bending Moment Sign Conventions

1. The bending moment is *positive* if it produces bending of the beam *concave upward* (compression in top fibers and tension in bottom fibers).
2. The shearing force is *positive* if the *right portion of the beam tends to shear downward with respect to the left*.

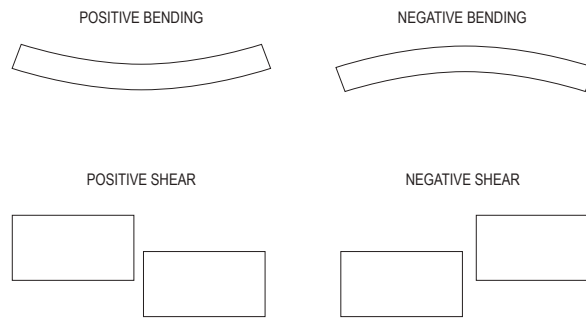

Timoshenko, S., and Gleason H. MacCullough, *Elements of Strengths of Materials*, K. Van Nostrand Co./Wadsworth Publishing Co., 1949.

The relationship between the load (w), shear (V), and moment (M) equations are:

$$w(x) = -\frac{dV(x)}{dx}$$

$$V = \frac{dM(x)}{dx}$$

$$V_2 - V_1 = \int_{x_1}^{x_2} [-w(x)] dx$$

$$M_2 - M_1 = \int_{x_1}^{x_2} V(x) dx$$

Stresses in Beams

The normal stress in a beam due to bending:

$$\sigma_x = -My/I$$

where

M = moment at the section

I = moment of inertia of the cross section

y = distance from the neutral axis to the fiber location above or below the neutral axis

The maximum normal stresses in a beam due to bending:

$$\sigma_x = \pm Mc/I$$

where

c = distance from the neutral axis to the outermost fiber of a symmetrical beam section

$$\sigma_x = -M/s$$

where

s = I/c : the elastic section modulus of the beam

Transverse shear stress:

$$\tau_{xy} = VQ/(Ib)$$

where

V = shear force

Q = $A'\bar{y}'$ = first moment of area above or below the point where shear stress is to be determined

Hibbeler, Russel C., *Mechanics of Materials*, 10th ed., Pearson, 2015, pp. 386 –387.

where

A' = area above the layer (or plane) upon which the desired transverse shear stress acts

\bar{y}' = distance from neutral axis to area centroid

b = width or thickness of the cross-section

Transverse shear flow:

$$q = VQ/I$$

Deflection of Beams

Using $1/\rho = M/(EI)$,

$$EI \frac{d^2y}{dx^2} = M, \text{ differential equation of deflection curve}$$

$$EI \frac{d^3y}{dx^3} = dM(x)/dx = V$$

$$EI \frac{d^4y}{dx^4} = dV(x)/dx = -w$$

Determine the deflection curve equation by double integration (apply boundary conditions applicable to the deflection and/or slope).

$$EI (dy/dx) = \int M(x) dx$$

$$EI y = \int \int M(x) dx dx$$

The constants of integration can be determined from the physical geometry of the beam.

Composite Sections

The bending stresses in a beam composed of dissimilar materials (Material 1 and Material 2) where $E_1 > E_2$ are:

$$\sigma_1 = -nMy/I_T$$

$$\sigma_2 = -My/I_T$$

where

I_T = moment of inertia of the transformed section

n = modular ratio E_1/E_2

E_1 = elastic modulus of Material 1

E_2 = elastic modulus of Material 2

y = distance from the neutral axis to the fiber location above or below the neutral axis

The composite section is transformed into a section composed of a single material. The centroid and then the moment of inertia are found on the transformed section for use in the bending stress equations.

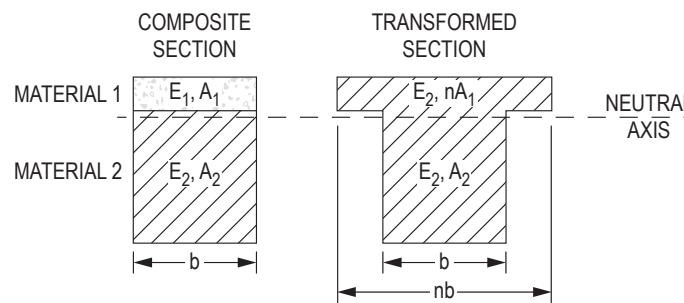

Columns

Critical axial load for long column subject to buckling:

Euler's Formula

$$P_{cr} = \frac{\pi^2 EI}{(K\ell)^2}$$

where

ℓ = unbraced column length

K = effective-length factor to account for end supports

Theoretical effective-length factors for columns include:

Pinned-pinned, $K = 1.0$

Fixed-fixed, $K = 0.5$

Fixed-pinned, $K = 0.7$

Fixed-free, $K = 2.0$

Critical buckling stress for long columns:

$$\sigma_{cr} = \frac{P_{cr}}{A} = \frac{\pi^2 E}{(K\ell/r)^2}$$

where

r = radius of gyration = $\sqrt{I/A}$

$K\ell/r$ = effective slenderness ratio for the column

Elastic Strain Energy

If the strain remains within the elastic limit, the work done during deflection (extension) of a member will be transformed into potential energy and can be recovered.

If the final load is P and the corresponding elongation of a tension member is δ , then the total energy U stored is equal to the work W done during loading.

$$U = W = P\delta/2$$

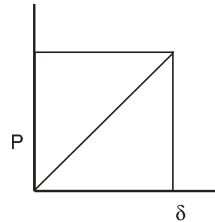

The strain energy per unit volume is

$$u = U/AL = \sigma^2/2E \quad (\text{for tension})$$

Material Properties

Table 1 - Typical Material Properties
(Use these values if the specific alloy and temper are not listed on Table 2 below)

Material	Modulus of Elasticity, E [Mpsi (GPa)]	Modulus of Rigidity, G [Mpsi (GPa)]	Poisson's Ratio, ν	Coefficient of Thermal Expansion, α [$10^{-6}/^{\circ}\text{F}$ ($10^{-6}/^{\circ}\text{C}$)]	Density, ρ [lb/in ³ (Mg/m ³)]
Steel	29.0 (200.0)	11.5 (80.0)	0.30	6.5 (11.7)	0.282 (7.8)
Aluminum	10.0 (69.0)	3.8 (26.0)	0.33	13.1 (23.6)	0.098 (2.7)
Cast Iron	14.5 (100.0)	6.0 (41.4)	0.21	6.7 (12.1)	0.246–0.282 (6.8–7.8)
Wood (Fir)	1.6 (11.0)	0.6 (4.1)	0.33	1.7 (3.0)	–
Brass	14.8–18.1 (102–125)	5.8 (40)	0.33	10.4 (18.7)	0.303–0.313 (8.4–8.7)
Copper	17 (117)	6.5 (45)	0.36	9.3 (16.6)	0.322 (8.9)
Bronze	13.9–17.4 (96–120)	6.5 (45)	0.34	10.0 (18.0)	0.278–0.314 (7.7–8.7)
Magnesium	6.5 (45)	2.4 (16.5)	0.35	14 (25)	0.061 (1.7)
Glass	10.2 (70)	–	0.22	5.0 (9.0)	0.090 (2.5)
Polystyrene	0.3 (2)	–	0.34	38.9 (70.0)	0.038 (1.05)
Polyvinyl Chloride (PVC)	<0.6 (<4)	–	–	28.0 (50.4)	0.047 (1.3)
Alumina Fiber	58 (400)	–	–	–	0.141 (3.9)
Aramide Fiber	18.1 (125)	–	–	–	0.047 (1.3)
Boron Fiber	58 (400)	–	–	–	0.083 (2.3)
Beryllium Fiber	43.5 (300)	–	–	–	0.069 (1.9)
BeO Fiber	58 (400)	–	–	–	0.108 (3.0)
Carbon Fiber	101.5 (700)	–	–	–	0.083 (2.3)
Silicon Carbide Fiber	58 (400)	–	–	–	0.116 (3.2)

Hibbeler, R.C., *Mechanics of Materials*, 4 ed., 2000. Reprinted by permission of Pearson Education, Inc., New York, New York.

Mechanics of Materials

**Table 2 - Average Mechanical Properties of Typical Engineering Materials
(U.S. Customary Units)**

(Use these values for the specific alloys and temper listed. For all other materials refer to Table 1 above.)

Materials	Specific Weight γ (lb/in ³)	Modulus of Elasticity E (10 ³ ksi)	Modulus of Rigidity G (10 ³ ksi)	Yield Strength (ksi)			Ultimate Strength (ksi)			% Elongation in 2 in. specimen	Poisson's Ratio ν	Coef. of Therm. Expansion α (10 ⁻⁶)/°F	
				Tens.	Comp.	Shear	Tens.	Comp.	Shear				
Metallic													
Aluminum Wrought Alloys	[2014-T6 6061-T6	0.101	10.6	3.9	60	60	25	68	68	42	10	0.35	12.8
		0.098	10.0	3.7	37	37	19	42	42	27	12	0.35	13.1
Cast Iron Alloys	[Gray ASTM 20 Malleable ASTM A-197	0.260	10.0	3.9	—	—	—	26	97	—	0.6	0.28	6.70
		0.263	25.0	9.8	—	—	—	40	83	—	5	0.28	6.60
Copper Alloys	[Red Brass C83400 Bronze C86100	0.316	14.6	5.4	11.4	11.4	—	35	35	—	35	0.35	9.80
		0.319	15.0	5.6	50	50	—	95	95	—	20	0.34	9.60
Magnesium Alloy	[Am 1004-T611]	0.066	6.48	2.5	22	22	—	40	40	22	1	0.30	14.3
Steel Alloys	[Structural A36 Stainless 304 Tool L2	0.284	29.0	11.0	36	36	—	58	58	—	30	0.32	6.60
		0.284	28.0	11.0	30	30	—	75	75	—	40	0.27	9.60
		0.295	29.0	11.0	102	102	—	116	116	—	22	0.32	6.50
Titanium Alloy	[Ti-6Al-4V]	0.160	17.4	6.4	134	134	—	145	145	—	16	0.36	5.20
Nonmetallic													
Concrete	[Low Strength High Strength	0.086	3.20	—	—	—	1.8	—	—	—	—	0.15	6.0
		0.086	4.20	—	—	—	5.5	—	—	—	—	0.15	6.0
Plastic Reinforced	[Kevlar 49 30% Glass	0.0524	19.0	—	—	—	—	104	70	10.2	2.8	0.34	—
		0.0524	10.5	—	—	—	—	13	19	—	—	0.34	—
Wood Select Structural Grade	[Douglas Fir White Spruce	0.017	1.90	—	—	—	—	0.30 ^c	3.78 ^d	0.90 ^d	—	0.29 ^c	—
		0.130	1.40	—	—	—	—	0.36 ^c	5.18 ^d	0.97 ^d	—	0.31 ^c	—

^a SPECIFIC VALUES MAY VARY FOR A PARTICULAR MATERIAL DUE TO ALLOY OR MINERAL COMPOSITION, MECHANICAL WORKING OF THE SPECIMEN, OR HEAT TREATMENT. FOR A MORE EXACT VALUE REFERENCE BOOKS FOR THE MATERIAL SHOULD BE CONSULTED.

^b THE YIELD AND ULTIMATE STRENGTHS FOR DUCTILE MATERIALS CAN BE ASSUMED EQUAL FOR BOTH TENSION AND COMPRESSION.

^c MEASURED PERPENDICULAR TO THE GRAIN.

^d MEASURED PARALLEL TO THE GRAIN.

^e DEFORMATION MEASURED PERPENDICULAR TO THE GRAIN WHEN THE LOAD IS APPLIED ALONG THE GRAIN.

Hibbeler, R.C., *Mechanics of Materials*, 4 ed., 2000. Reprinted by permission of Pearson Education, Inc., New York, New York.

Simply Supported Beam Slopes and Deflections

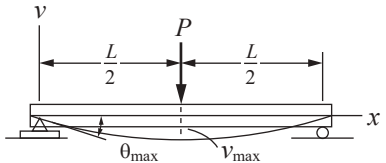
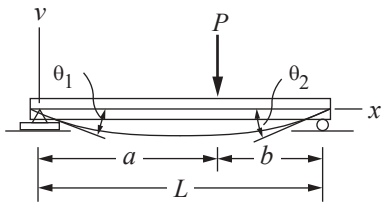
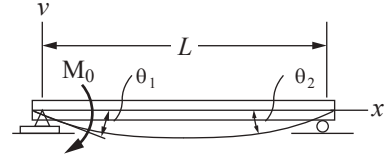
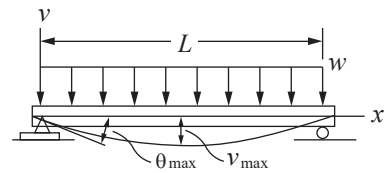
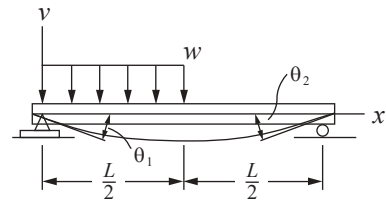
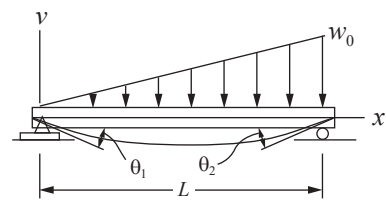
BEAM	SLOPE	DEFLECTION	ELASTIC CURVE	MAXIMUM MOMENT
	$\theta_{\max} = \frac{-PL^2}{16EI}$	$v_{\max} = \frac{-PL^3}{48EI}$	$v = \frac{-Px}{48EI} (3L^2 - 4x^2)$ $0 \leq x \leq L/2$	$M_{\max} \text{ (at center)} = \frac{PL}{4}$
	$\theta_1 = \frac{-Pab(L+b)}{6EIL}$ $\theta_2 = \frac{Pab(L+a)}{6EIL}$	$v _{x=a} = \frac{-Pba}{6EIL} (L^2 - b^2 - a^2)$	$v = \frac{-Pbx}{6EIL} (L^2 - b^2 - x^2)$ $0 \leq x \leq a$	$M_{\max} \text{ (at point of load)} = \frac{Pab}{L}$
	$\theta_1 = \frac{-M_0L}{3EI}$ $\theta_2 = \frac{M_0L}{6EI}$	$v_{\max} = \frac{-M_0L^2}{\sqrt{243EI}}$	$v = \frac{-M_0x}{6EIL} (x^2 - 3Lx + 2L^2)$	$M_{\max} \text{ (at } x = 0) = M_0$
	$\theta_{\max} = \frac{-wL^3}{24EI}$	$v_{\max} = \frac{-5wL^4}{384EI}$	$v = \frac{-wx}{24EI} (x^3 - 2Lx^2 + L^3)$	$M_{\max} \text{ (at center)} = \frac{wL^2}{8}$
	$\theta_1 = \frac{-3wL^3}{128EI}$ $\theta_2 = \frac{7wL^3}{384EI}$	$v _{x=L/2} = \frac{-5wL^4}{768EI}$ $v_{\max} = -0.006563 \frac{wL^4}{EI}$ at $x = 0.4598L$	$v = \frac{-wx}{384EI} (16x^3 - 24Lx^2 + 9L^3)$ $0 \leq x \leq L/2$ $v = \frac{-wL}{384EI} (8x^3 - 24Lx^2 + 17L^2x - L^3)$ $L/2 \leq x < L$	$M_{\max} \left(\text{at } x = \frac{3}{8}l \right) = \frac{9}{128}wL^2$
	$\theta_1 = \frac{-7w_0L^3}{360EI}$ $\theta_2 = \frac{w_0L^3}{45EI}$	$v_{\max} = -0.00652 \frac{w_0L^4}{EI}$ at $x = 0.5193L$	$v = \frac{-w_0x}{360EIL} (3x^4 - 10L^2x^2 + 7L^4)$	$M_{\max} \left(\text{at } x = \frac{L}{\sqrt{3}} \right) = \frac{w_0L^2}{9\sqrt{3}}$

Cantilevered Beam Slopes and Deflections

BEAM	SLOPE	DEFLECTION	ELASTIC CURVE	MAXIMUM MOMENT
	$\theta_{\max} = \frac{-Pa^2}{2EI}$	$v_{\max} = \frac{-Pa^2}{6EI} (3L - a)$	$v = \frac{-Pa^2}{6EI} (3x - a), \text{ for } x > a$ $v = \frac{-Px^2}{6EI} (-x + 3a), \text{ for } x \leq a$	$M_{\max} (\text{at } x = 0) = Pa$
	$\theta_{\max} = \frac{-wL^3}{6EI}$	$v_{\max} = \frac{-wL^4}{8EI}$	$v = \frac{-wx^2}{24EI} (x^2 - 4Lx + 6L^2)$	$M_{\max} (\text{at } x = 0) = \frac{wL^2}{2}$
	$\theta_{\max} = \frac{M_0L}{EI}$	$v_{\max} = \frac{M_0L^2}{2EI}$	$v = \frac{M_0x^2}{2EI}$	$M_{\max} (\text{at all } x) = M_0$
	$\theta_{\max} = \frac{-wL^3}{48EI}$	$v_{\max} = \frac{-7wL^4}{384EI}$	$v = \frac{-wx^2}{24EI} \left(x^2 - 2Lx + \frac{3}{2}L^2 \right) \quad 0 \leq x \leq L/2$ $v = \frac{-wL^3}{192EI} (4x - L/2) \quad L/2 \leq x \leq L$	$M_{\max} (\text{at } x = 0) = \frac{wL^2}{8}$
	$\theta_{\max} = \frac{-w_0L^3}{24EI}$	$v_{\max} = \frac{-w_0L^4}{30EI}$	$v = \frac{-w_0x^2}{120EI} (10L^3 - 10L^2x + 5Lx^2 - x^3)$	$M_{\max} (\text{at } x = 0) = \frac{w_0L^2}{6}$

Piping Segment Slopes and Deflections

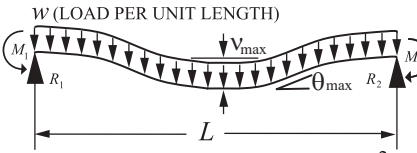
PIPE	SLOPE	DEFLECTION	ELASTIC CURVE	MAXIMUM MOMENT
 <p> $R_1 = R_2 = \frac{wL}{2}$ and $M_1 = M_2 = \frac{wL^2}{12}$ </p>	$ \theta_{\max} = 0.008 \frac{wL^3}{24EI}$ $\text{at } x = \frac{1}{2} \pm \frac{L}{\sqrt{12}}$	$ v_{\max} = \frac{wL^4}{384EI} \text{ at } x = \frac{L}{2}$	$v(x) = \frac{wx^2}{24EI} (L^2 - 2Lx + x^2)$	$M_{\max} \text{ (at } x = 0) = \frac{wL^2}{12}$

Adapted from Crandall, S.H. and N.C. Dahl, *An Introduction to Mechanics of Solids*, McGraw-Hill, New York, 1959.

Thermodynamics

Properties of Single-Component Systems

Nomenclature

1. Intensive properties are independent of mass.
2. Extensive properties are proportional to mass.
3. Specific properties are lowercase (extensive/mass).

State Functions (properties)

Functions and Their Symbols and Units

Function	Symbol(s)	Unit (I-P or SI)
Absolute pressure	P	$\frac{\text{lbf}}{\text{in}^2}$ or Pa
Absolute temperature	T	$^{\circ}\text{R}$ or K
Volume	V	ft^3 or m^3
Specific volume	$v = \frac{V}{m}$	$\frac{\text{ft}^3}{\text{lbm}}$ or $\frac{\text{m}^3}{\text{kg}}$
Internal energy	U	Btu or kJ
Specific internal energy	$u = \frac{U}{m}$	$\frac{\text{Btu}}{\text{lbm}}$ or $\frac{\text{kJ}}{\text{kg}}$
Enthalpy	H	Btu or kJ
Specific enthalpy	$h = u + Pv = \frac{H}{m}$	$\frac{\text{Btu}}{\text{lbm}}$ or $\frac{\text{kJ}}{\text{kg}}$
Entropy	S	$\frac{\text{Btu}}{^{\circ}\text{R}}$ or $\frac{\text{kJ}}{\text{K}}$
Specific entropy	$s = \frac{S}{m}$	$\frac{\text{Btu}}{\text{lbm}\cdot^{\circ}\text{R}}$ or $\frac{\text{kJ}}{\text{kg}\cdot\text{K}}$
Gibbs free energy	$G = h - Ts$	$\frac{\text{Btu}}{\text{lbm}}$ or $\frac{\text{kJ}}{\text{kg}}$
Helmholtz free energy	$A = u - Ts$	$\frac{\text{Btu}}{\text{lbm}}$ or $\frac{\text{kJ}}{\text{kg}}$

For a single-phase pure component, specification of any two intensive, independent properties is sufficient to fix all the rest.

Specific Heat (Heat Capacity) at Constant Pressure,

$$c_p = \left(\frac{\partial h}{\partial T} \right)_p \quad [\text{Btu}/(\text{lbm}\cdot^{\circ}\text{R}) \text{ or } \text{kJ}/(\text{kg}\cdot\text{K})]$$

Specific Heat (Heat Capacity) at Constant Volume,

$$c_v = \left(\frac{\partial u}{\partial T} \right)_v \quad [\text{Btu}/(\text{lbm}\cdot^{\circ}\text{R}) \text{ or } \text{kJ}/(\text{kg}\cdot\text{K})]$$

The steam tables in this section provide T , P , v , u , h , and s data for saturated and superheated water.

P - h diagrams and tables for Refrigerant 134A and 410A, providing T , P , v , h , and s data, are included in this section.

Thermal and physical property tables for selected gases, liquids, and solids are included in this section.

Properties for Two-Phase (vapor-liquid) Systems

Quality x (for liquid-vapor systems at saturation) is defined as the mass fraction of the vapor phase:

$$x = m_g / (m_g + m_f)$$

where

m_g = mass of vapor

m_f = mass of liquid

Specific volume of a two-phase system can be written:

$$v = xv_g + (1 - x)v_f \text{ or } v = v_f + xv_{fg}$$

where

v_f = specific volume of saturated liquid

v_g = specific volume of saturated vapor

v_{fg} = specific volume change upon vaporization

$$= v_g - v_f$$

Similar expressions exist for u , h , and s :

$$u = xu_g + (1 - x)u_f \text{ or } u = u_f + xu_{fg}$$

$$h = xh_g + (1 - x)h_f \text{ or } h = h_f + xh_{fg}$$

$$s = xs_g + (1 - x)s_f \text{ or } s = s_f + xs_{fg}$$

PVT Behavior

Ideal Gas

For an ideal gas

$$Pv = RT \text{ or } PV = mRT, \text{ and}$$

$$P_1v_1/T_1 = P_2v_2/T_2$$

where

P = pressure

v = specific volume

m = mass of gas

R = gas constant

T = absolute temperature

V = volume

R is *specific to each gas* but can be found from

$$R_i = \frac{\bar{R}}{(\text{mol. wt})_i}$$

where

\bar{R} = universal gas constant

$$= 1,545 \text{ ft}\cdot\text{lbf}/(\text{lbmol}\cdot^\circ\text{R}) = 8,314 \text{ J}/(\text{kmol}\cdot\text{K})$$

$$= 8.314 \text{ kPa}\cdot\text{m}^3/(\text{kmol}\cdot\text{K}) = 0.08206 \text{ L}\cdot\text{atm}/(\text{mole}\cdot\text{K})$$

For *ideal gases*, $c_p - c_v = R$

Ideal gas behavior is characterized by:

- no intermolecular interactions
- molecules occupy zero volume

The properties of an ideal gas reflect those of a single molecule and are attributable entirely to the structure of the molecule and the system T .

For *ideal gases*:

$$\left(\frac{\partial h}{\partial P}\right)_T = 0 \quad \left(\frac{\partial u}{\partial v}\right)_T = 0$$

For cold air standard, *heat capacities are assumed to be constant* at their room temperature values. In that case, the following are true:

$$\begin{aligned} \Delta u &= c_v \Delta T; \quad \Delta h = c_p \Delta T \\ \Delta s &= c_p \ln(T_2/T_1) - R \ln(P_2/P_1) \\ \Delta s &= c_v \ln(T_2/T_1) + R \ln(v_2/v_1) \end{aligned}$$

Also, for *constant entropy* processes:

$$\begin{aligned} \frac{P_2}{P_1} &= \left(\frac{v_1}{v_2}\right)^k; \quad \frac{T_2}{T_1} = \left(\frac{P_2}{P_1}\right)^{\frac{k-1}{k}} \\ \frac{T_2}{T_1} &= \left(\frac{v_1}{v_2}\right)^{k-1}, \quad \text{where } k = c_p/c_v \end{aligned}$$

Ideal Gas Mixtures

$i = 1, 2, \dots, n$ constituents. Each constituent is an ideal gas.

Mole Fraction:

$$x_i = N_i/N; \quad N = \sum N_i; \quad \sum x_i = 1$$

where N_i = number of moles of component i

N = total moles in the mixture

Mass Fraction: $y_i = m_i/m; \quad m = \sum m_i; \quad \sum y_i = 1$

Molecular Weight: $M = m/N = \sum x_i M_i$

To convert *mole fractions* x_i to *mass fractions* y_i :

$$y_i = \frac{x_i M_i}{\sum (x_i M_i)}$$

To convert *mass fractions* to *mole fractions*:

$$x_i = \frac{y_i/M_i}{\sum (y_i/M_i)}$$

Partial Pressures: $P_i = \frac{m_i R_i T}{V}$ and $P = \sum P_i$

Partial Volumes: $V_i = \frac{m_i R_i T}{P}$ and $V = \sum V_i$

where P, V, T = pressure, volume, and temperature of the mixture and $R_i = \bar{R}/M_i$

Combining the above generates the following additional expressions for mole fraction.

$$x_i = P_i/P = V_i/V$$

Other Properties:

$$c_p = \sum (y_i c_{p_i})$$

$$c_v = \sum (y_i c_{v_i})$$

$$u = \sum (y_i u_i); \quad h = \sum (y_i h_i); \quad s = \sum (y_i s_i)$$

u_i and h_i are evaluated at T

s_i is evaluated at T and P_i

Real Gas

Most gases exhibit ideal gas behavior when the system pressure is less than 3 atm since the distance between molecules is large enough to produce negligible molecular interactions. The behavior of a real gas deviates from that of an ideal gas at higher pressures due to molecular interactions.

For a real gas, $Pv = ZRT$

where

Z = compressibility factor

$Z = 1$ for an ideal gas

$Z \neq 1$ for a real gas

Equations of State (EOS)

EOS are used to quantify PvT behavior

Ideal Gas EOS (applicable only to ideal gases)

$$P = \left(\frac{RT}{v} \right)$$

Generalized Compressibility EOS (applicable to all systems as gases, liquids, and/or solids)

$$P = \left(\frac{RT}{v} \right) Z$$

Virial EOS (applicable only to gases)

$$P = \left(\frac{RT}{v} \right) \left(1 + \frac{B}{v} + \frac{C}{v^2} + \dots \right)$$

where B, C, \dots are virial coefficients obtained from PvT measurements or statistical mechanics.

Cubic EOS (theoretically motivated with intent to predict gas and liquid thermodynamic properties)

$$P = \frac{RT}{v-b} - \frac{a(T)}{(v+c_1b)(v+c_2b)}$$

where $a(T), b,$ and c_1 and c_2 are species specific.

An example of a cubic EOS is the Van der Waals equation with constants based on the critical point:

$$\left(P + \frac{a}{v^2} \right) (v - b) = \overline{R}T$$

where $a = \left(\frac{27}{64} \right) \left(\frac{\overline{R}^2 T_c^2}{P_c} \right), \quad b = \frac{\overline{R}T_c}{8P_c}$

where P_c and T_c are the pressure and temperature at the critical point, respectively, and v is the molar specific volume.

EOS are used to predict:

- $P, v,$ or T when two of the three are specified
- other thermodynamic properties based on analytic manipulation of the EOS
- mixture properties using appropriate mixing rules to create a pseudo-component that mimics the mixture properties

The Theorem of Corresponding States asserts that all normal fluids have the same value of Z at the same reduced temperature T_r and pressure P_r .

$$T_r = \frac{T}{T_c} \quad P_r = \frac{P}{P_c}$$

where T_c and P_c are the critical temperature and pressure, respectively, expressed in absolute units.

First Law of Thermodynamics

The *First Law of Thermodynamics* is a statement of conservation of energy in a thermodynamic system. The net energy crossing the system boundary is equal to the change in energy inside the system.

Heat Q ($q = Q/m$) is *energy transferred* due to temperature difference and is considered positive if it is inward or added to the system.

Work W ($w = W/m$) is considered *positive if it is outward* or *work done* by the system.

Closed Thermodynamic System

No mass crosses system boundary

$$Q - W = \Delta U + \Delta KE + \Delta PE$$

where

ΔU = change in internal energy

ΔKE = change in kinetic energy

ΔPE = change in potential energy

Energy can cross the boundary only in the form of heat or work. Work can be boundary work, w_b , or other work forms (electrical work, etc.)

Reversible boundary work is given by $w_b = \int P dv$.

Special Cases of Closed Systems (with no change in kinetic or potential energy)

Constant System Pressure process (**Charles' Law**):

$$w_b = P\Delta v$$

(ideal gas) $T/v = \text{constant}$

Constant Volume process:

$$w_b = 0$$

(ideal gas) $T/P = \text{constant}$

Isentropic process (ideal gas):

$$Pv^k = \text{constant}$$

$$w = (P_2v_2 - P_1v_1)/(1 - k)$$

$$= R(T_2 - T_1)/(1 - k)$$

Constant Temperature process (**Boyle's Law**): (ideal gas) $Pv = \text{constant}$

$$w_b = RT \ln (v_2 / v_1) = RT \ln (P_1 / P_2)$$

Polytropic process (ideal gas):

$$Pv^n = \text{constant}$$

$$w = (P_2v_2 - P_1v_1)/(1 - n), n \neq 1$$

Open Thermodynamic System

Mass crosses the system boundary.

There is flow work (Pv) done by mass entering the system.

The reversible flow work is given by:

$$w_{rev} = - \int v dP + \Delta KE + \Delta PE$$

First Law applies whether or not processes are reversible.

Open System First Law (energy balance)

$$\Sigma \dot{m}_i [h_i + V_i^2/2 + gZ_i] - \Sigma \dot{m}_e [h_e + V_e^2/2 + gZ_e] + \dot{Q}_m - \dot{W}_{net} = d(m_s u_s)/dt$$

where

\dot{W}_{net} = rate of net or shaft work

\dot{m} = mass flowrate (subscripts i and e refer to inlet and exit states of system)

g = acceleration of gravity

Z = elevation

V = velocity

m_s = mass of fluid within the system

u_s = specific internal energy of system

\dot{Q}_{in} = rate of heat transfer (neglecting kinetic and potential energy of the system)

Special Cases of Open Systems (with no change in kinetic or potential energy)

Constant Volume process:

$$w_{rev} = -v(P_2 - P_1)$$

Constant System Pressure process:

$$w_{rev} = 0$$

Constant Temperature process: (ideal gas) $Pv = \text{constant}$

$$w_{rev} = RT \ln(v_2/v_1) = RT \ln(P_1/P_2)$$

Isentropic process (ideal gas):

$$Pv^k = \text{constant}$$

$$w_{rev} = k(P_2v_2 - P_1v_1)/(1 - k)$$

$$= kR(T_2 - T_1)/(1 - k)$$

$$w_{rev} = \frac{k}{k - 1} RT_1 \left[1 - \left(\frac{P_2}{P_1} \right)^{(k - 1)/k} \right]$$

Polytropic process (ideal gas):

$$Pv^n = \text{constant}$$

Closed system

$$w_{rev} = (P_2v_2 - P_1v_1)/(1 - n)$$

One-inlet, one-exit control volume

$$w_{rev} = n(P_2v_2 - P_1v_1)/(1 - n)$$

Steady-Flow Systems

The system does not change state with time. This assumption is valid for steady operation of turbines, pumps, compressors, throttling valves, nozzles, and heat exchangers, including boilers and condensers.

$$\sum \dot{m}_i (h_i + V_i^2/2 + gZ_i) - \sum \dot{m}_e (h_e + V_e^2/2 + gZ_e) + \dot{Q}_{in} - \dot{W}_{out} = 0$$

and

$$\sum \dot{m}_i = \sum \dot{m}_e$$

where

\dot{m} = mass flowrate (subscripts i and e refer to inlet and exit states of system)

g = acceleration of gravity

Z = elevation

V = velocity

\dot{Q}_{in} = net rate of heat transfer into the system

\dot{W}_{out} = net rate of work out of the system

Special Cases of Steady-Flow Energy Equation

Nozzles, Diffusers: Velocity terms are significant. No elevation change, no heat transfer, and no work. Single-mass stream.

$$h_i + V_i^2/2 = h_e + V_e^2/2$$

$$\text{Isentropic Efficiency (nozzle)} = \frac{V_e^2 - V_i^2}{2(h_i - h_{es})}$$

where h_{es} = enthalpy at isentropic exit state.

Turbines, Pumps, Compressors: Often considered adiabatic (no heat transfer). Velocity terms usually can be ignored. There are significant work terms and a single-mass stream.

$$h_i = h_e + w$$

$$\text{Isentropic Efficiency (turbine)} = \frac{h_i - h_e}{h_i - h_{es}}$$

$$\text{Isentropic Efficiency (compressor, pump)} = \frac{h_{es} - h_i}{h_e - h_i}$$

For pump only, $h_{es} - h_i = v_i(P_e - P_i)$

Throttling Valves and Throttling Processes: No work, no heat transfer, and single-mass stream. Velocity terms are often insignificant.

$$h_i = h_e$$

Boilers, Condensers, Evaporators, One Side in a Heat

Exchanger: Heat transfer terms are significant. For a single-mass stream, the following applies:

$$h_i + q = h_e$$

Heat Exchangers: No heat loss to the surroundings or work. Two separate flowrates \dot{m}_1 and \dot{m}_2 :

$$\dot{m}_1(h_{1i} - h_{1e}) = \dot{m}_2(h_{2e} - h_{2i})$$

Mixers, Separators, Open or Closed Feedwater Heaters:

$$\Sigma \dot{m}_i h_i = \Sigma \dot{m}_e h_e \quad \text{and}$$

$$\Sigma \dot{m}_i = \Sigma \dot{m}_e$$

Basic Cycles

Heat engines take in heat Q_H at a high temperature T_H , produce a net amount of work W , and reject heat Q_L at a low temperature T_L . The efficiency η of a heat engine is given by:

$$\eta = W/Q_H = (Q_H - Q_L)/Q_H$$

The most efficient engine possible is the *Carnot Cycle*. Its efficiency is given by:

$$\eta_c = (T_H - T_L)/T_H$$

where T_H and T_L = absolute temperatures (Kelvin or Rankine).

The following heat-engine cycles are plotted on P - v and T - s diagrams in this section:

Carnot, Otto, Rankine

Refrigeration cycles are the reverse of heat-engine cycles. Heat is moved from low to high temperature requiring work, W . Cycles can be used either for refrigeration or as heat pumps.

Coefficient of Performance (COP) is defined as:

$$\text{COP} = Q_H/W \text{ for heat pumps, and as}$$

$$\text{COP} = Q_L/W \text{ for refrigerators and air conditioners.}$$

Upper limit of COP is based on reversed Carnot Cycle:

$$\text{COP}_c = T_H / (T_H - T_L) \text{ for heat pumps and}$$

$$\text{COP}_c = T_L / (T_H - T_L) \text{ for refrigeration.}$$

1 ton refrigeration = 12,000 Btu/hr = 3,516 W

The following refrigeration cycles are plotted on T - s diagrams in this section: reversed rankine, two-stage refrigeration, air refrigeration

Psychrometrics

Properties of an air-water vapor mixture at a fixed pressure are given in graphical form on a psychrometric chart as provided in this section. When the system pressure is 1 atm, an ideal-gas mixture is assumed.

The definitions that follow use subscript a for dry air and v for water vapor.

P = pressure of the air-water mixture, normally 1 atm

T = dry-bulb temp (air/water mixture temperature)

P_a = partial pressure of dry air

P_v = partial pressure of water vapor

$$P = P_a + P_v$$

Specific Humidity (absolute humidity, humidity ratio) ω :

$$\omega = m_v / m_a$$

where

m_v = mass of water vapor

m_a = mass of dry air

$$\omega = 0.622 P_v / P_a = 0.622 P_v / (P - P_v)$$

Relative Humidity (rh) ϕ :

$$\phi = P_v / P_g$$

where P_g = saturation pressure of water at T .

Enthalpy h :

$$h = h_a + \omega h_v$$

Dew-Point Temperature T_{dp} :

$$T_{dp} = T_{\text{sat}} \text{ at } P_g = P_v$$

Wet-bulb temperature T_{wb} is the temperature indicated by a thermometer covered by a wick saturated with liquid water and in contact with moving air.

Humid Volume: Volume of moist air/mass of dry air.

Second Law of Thermodynamics

Thermal Energy Reservoirs

$$\Delta S_{\text{reservoir}} = Q / T_{\text{reservoir}}$$

where Q is measured with respect to the reservoir.

Kelvin-Planck Statement of Second Law

No heat engine can operate in a cycle while transferring heat with a single heat reservoir.

COROLLARY to Kelvin-Planck: No heat engine can have a higher efficiency than a Carnot Cycle operating between the same reservoirs.

Clausius' Statement of Second Law

No refrigeration or heat pump cycle can operate without a net work input.

COROLLARY: No refrigerator or heat pump can have a higher COP than a Carnot Cycle refrigerator or heat pump.

Entropy

$$ds = (1/T)\delta q_{rev}$$

$$s_2 - s_1 = \int_1^2 (1/T)\delta q_{rev}$$

Inequality of Clausius

$$\oint (1/T)\delta q_{rev} \leq 0$$

$$\int_1^2 (1/T)\delta q \leq s_2 - s_1$$

Isothermal, Reversible Process

$$\Delta s = s_2 - s_1 = q/T$$

Isentropic Process

$$\Delta s = 0; ds = 0$$

A reversible adiabatic process is isentropic.

Adiabatic Process

$$\delta q = 0; \Delta s \geq 0$$

Increase of Entropy Principle

$$\Delta s_{total} = \Delta s_{system} + \Delta s_{surroundings} \geq 0$$

$$\Delta \dot{s}_{total} = \sum \dot{m}_{out} s_{out} - \sum \dot{m}_{in} s_{in} - \sum (\dot{q}_{external}/T_{external}) \geq 0$$

Temperature-Entropy (*T-s*) Diagram

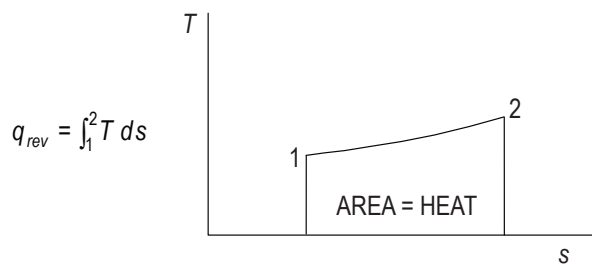

Entropy Change for Solids and Liquids

$$ds = c (dT/T)$$

$$s_2 - s_1 = \int c (dT/T) = c_{mean} \ln (T_2/T_1),$$

where *c* equals the heat capacity of the solid or liquid.

Exergy (Availability)

Exergy (also known as availability) is the maximum possible work that can be obtained from a cycle of a heat engine. The maximum possible work is obtained in a reversible process.

Closed-System Exergy (Availability)

(no chemical reactions)

$$\phi = (u - u_L) - T_L(s - s_L) + p_L(v - v_L)$$

where the subscript L designates environmental conditions and ϕ is availability function.

$$w_{\max} = w_{\text{rev}} = \phi_1 - \phi_2$$

Open-System Exergy (Availability)

$$\Psi = (h - h_L) - T_L(s - s_L) + V^2/2 + gZ$$

where V is velocity, g is acceleration of gravity, Z is elevation and Ψ is availability function.

$$w_{\max} = w_{\text{rev}} = \Psi_1 - \Psi_2$$

Gibbs Free Energy, ΔG

Energy released or absorbed in a reaction occurring reversibly at constant pressure and temperature.

Helmholtz Free Energy, ΔA

Energy released or absorbed in a reaction occurring reversibly at constant volume and temperature.

Irreversibility, I

$$I = w_{\text{rev}} - w_{\text{actual}} = T_L \Delta s_{\text{total}}$$

Heats of Reaction

For a chemical reaction the associated energy can be defined in terms of heats of formation of the individual species ΔH_f° at the standard state

$$(\Delta H_r^\circ) = \sum_{\text{products}} \nu_i (\Delta H_f^\circ)_i - \sum_{\text{reactants}} \nu_i (\Delta H_f^\circ)_i$$

ν_i = stoichiometric coefficient for species " i "

The standard state is 25°C and 1 bar.

The heat of formation is defined as the enthalpy change associated with the formation of a compound from its atomic species as they normally occur in nature [i.e., $\text{O}_2(\text{g})$, $\text{H}_2(\text{g})$, $\text{C}(\text{solid})$, etc.]

The heat of reaction varies with the temperature as follows:

$$\Delta H_r^\circ(T) = \Delta H_r^\circ(T_{\text{ref}}) + \int_{T_{\text{ref}}}^T \Delta c_p dT$$

where T_{ref} is some reference temperature (typically 25°C or 298 K), and:

$$\Delta c_p = \sum_{\text{products}} \nu_i c_{p,i} - \sum_{\text{reactants}} \nu_i c_{p,i}$$

and $c_{p,i}$ is the molar heat capacity of component i .

The heat of reaction for a combustion process using oxygen is also known as the heat of combustion. The principal products are $\text{CO}_2(\text{g})$ and $\text{H}_2\text{O}(\text{l})$.

Combustion Processes

First, the combustion equation should be written and balanced. For example, for the stoichiometric combustion of methane in oxygen:

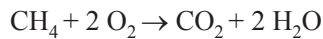

Combustion in Air

For each mole of oxygen, there will be 3.76 moles of nitrogen. For stoichiometric combustion of methane in air:

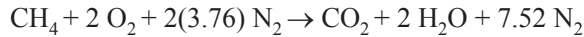

Combustion in Excess Air

The excess oxygen appears as oxygen on the right side of the combustion equation.

Incomplete Combustion

Some carbon is burned to create carbon monoxide (CO).

$$\text{Molar Air-Fuel Ratio, } \overline{A/F} = \frac{\text{No. of moles of air}}{\text{No. of moles of fuel}}$$

$$\text{Air-Fuel Ratio, } A/F = \frac{\text{Mass of air}}{\text{Mass of fuel}} = (\overline{A/F}) \left(\frac{M_{\text{air}}}{M_{\text{fuel}}} \right)$$

Stoichiometric (theoretical) air-fuel ratio is the air-fuel ratio calculated from the stoichiometric combustion equation.

$$\text{Percent Theoretical Air} = \frac{(A/F)_{\text{actual}}}{(A/F)_{\text{stoichiometric}}} \times 100$$

$$\text{Percent Excess Air} = \frac{(A/F)_{\text{actual}} - (A/F)_{\text{stoichiometric}}}{(A/F)_{\text{stoichiometric}}} \times 100$$

Vapor-Liquid Equilibrium (VLE)

Henry's Law at Constant Temperature

At equilibrium, the partial pressure of a gas is proportional to its concentration in a liquid. Henry's Law is valid for low concentrations; i.e., $x \approx 0$.

$$P_i = P y_i = h x_i$$

where

h = Henry's Law constant

P_i = partial pressure of a gas in contact with a liquid

x_i = mol fraction of the gas in the liquid

y_i = mol fraction of the gas in the vapor

P = total pressure

Raoult's Law for Vapor-Liquid Equilibrium

Valid for concentrations near 1; i.e., $x_i \approx 1$ at low pressure (ideal gas behavior)

$$P_i = x_i P_i^*$$

where

P_i = partial pressure of component i

x_i = mol fraction of component i in the liquid

P_i^* = vapor pressure of pure component i at the temperature of the mixture

Rigorous Vapor-Liquid Equilibrium

For a multicomponent mixture at equilibrium

$$\hat{f}_i^V = \hat{f}_i^L$$

where

$$\hat{f}_i^V = \text{fugacity of component } i \text{ in the vapor phase}$$

$$\hat{f}_i^L = \text{fugacity of component } i \text{ in the liquid phase}$$

Fugacities of component i in a mixture are commonly calculated in the following ways:

$$\text{For a liquid } \hat{f}_i^L = x_i \gamma_i f_i^L$$

where

$$x_i = \text{mole fraction of component } i$$

$$\gamma_i = \text{activity coefficient of component } i$$

$$f_i^L = \text{fugacity of pure liquid component } i$$

$$\text{For a vapor } \hat{f}_i^V = y_i \hat{\Phi}_i P$$

where

$$y_i = \text{mole fraction of component } i \text{ in the vapor}$$

$$\hat{\Phi}_i = \text{fugacity coefficient of component } i \text{ in the vapor}$$

$$P = \text{system pressure}$$

The activity coefficient γ_i is a correction for liquid phase nonideality. Many models have been proposed for γ_i such as the Van Laar model:

$$\ln \gamma_1 = A_{12} \left(1 + \frac{A_{12} x_1}{A_{21} x_2} \right)^{-2}$$

$$\ln \gamma_2 = A_{21} \left(1 + \frac{A_{21} x_2}{A_{12} x_1} \right)^{-2}$$

where

$$\gamma_1 = \text{activity coefficient of component 1 in a two-component system}$$

$$\gamma_2 = \text{activity coefficient of component 2 in a two-component system}$$

$$A_{12}, A_{21} = \text{constants, typically fitted from experimental data}$$

The pure component fugacity is calculated as:

$$f_i^L = \Phi_i^{\text{sat}} P_i^{\text{sat}} \exp \left\{ v_i^L (P - P_i^{\text{sat}}) / (RT) \right\}$$

where

$$\Phi_i^{\text{sat}} = \text{fugacity coefficient of pure saturated } i$$

$$P_i^{\text{sat}} = \text{saturation pressure of pure } i$$

$$v_i^L = \text{specific volume of pure liquid } i$$

$$R = \text{Ideal Gas Law Constant}$$

$$T = \text{absolute temperature}$$

Often at system pressures close to atmospheric:

$$f_i^L \cong P_i^{\text{sat}}$$

The fugacity coefficient $\hat{\Phi}_i$ for component i in the vapor is calculated from an equation of state (e.g., Virial).

Sometimes it is approximated by a pure component value from a correlation. Often at pressures close to atmospheric, $\hat{\Phi}_i = 1$.

The fugacity coefficient is a correction for vapor phase nonideality.

For sparingly soluble gases the liquid phase is sometimes represented as:

$$\hat{f}_i^L = x_i k_i$$

where k_i is a constant set by experiment (Henry's constant). Sometimes other concentration units are used besides mole fraction with a corresponding change in k_i .

Phase Relations

Clapeyron Equation for phase transitions:

$$\left(\frac{dP}{dT}\right)_{\text{sat}} = \frac{h_{fg}}{T v_{fg}} = \frac{s_{fg}}{v_{fg}}$$

where

h_{fg} = enthalpy change for phase transitions

v_{fg} = volume change

s_{fg} = entropy change

T = absolute temperature

$(dP/dT)_{\text{sat}}$ = slope of phase transition (e.g., vapor-liquid) saturation line

Clausius-Clapeyron Equation

This equation results if it is assumed that (1) the volume change (v_{fg}) can be replaced with the vapor volume (v_g), (2) the latter can be replaced with $P/\bar{R}T$ from the ideal gas law, and (3) h_{fg} is independent of the temperature (T).

$$\ln_e\left(\frac{P_2}{P_1}\right) = \frac{h_{fg}}{\bar{R}} \cdot \frac{T_2 - T_1}{T_1 T_2}$$

Gibbs Phase Rule (non-reacting systems)

$$P + F = C + 2$$

where

P = number of phases making up a system

F = degrees of freedom

C = number of components in a system

Chemical Reaction Equilibria

Definitions

Conversion – moles reacted/moles fed

Extent – For each species in a reaction, the mole balance may be written:

$$\text{moles}_{i,\text{out}} = \text{moles}_{i,\text{in}} + v_i \xi$$

where ξ is the extent in moles and v_i is the stoichiometric coefficient of the i th species, the sign of which is negative for reactants and positive for products.

Limiting reactant – Reactant that would be consumed first if the reaction proceeded to completion. Other reactants are excess reactants.

Selectivity – Moles of desired product formed/moles of undesired product formed.

Yield – Moles of desired product formed/moles that would have been formed if there were no side reactions and the limiting reactant had reacted completely.

Chemical Reaction Equilibrium

For the reaction

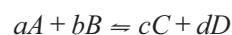

$$\Delta G_i = -RT \ln K_a$$

$$K_a = \frac{(\hat{a}_C^c)(\hat{a}_D^d)}{(\hat{a}_A^a)(\hat{a}_B^b)} = \prod_i (\hat{a}_i)^{\nu_i}$$

where

$$\hat{a}_i = \text{activity of component } i = \frac{\hat{f}_i}{f_i^\circ}$$

f_i° = fugacity of pure i in its standard state at the equilibrium reaction temperature T

ν_i = stoichiometric coefficient of component i

ΔG° = standard Gibbs energy change of reaction

K_a = chemical equilibrium constant

For mixtures of ideal gases:

f_i° = unit pressure, often 1 bar

$$\hat{f}_i = y_i P = p_i$$

where p_i = partial pressure of component i

$$\text{Then } K_a = K_p = \frac{(p_C^c)(p_D^d)}{(p_A^a)(p_B^b)} = P^{c+d-a-b} \frac{(y_C^c)(y_D^d)}{(y_A^a)(y_B^b)}$$

For solids $\hat{a}_i = 1$

For liquids $\hat{a}_i = x_i \gamma_i$

The effect of temperature on the equilibrium constant is

$$\frac{d \ln K}{dT} = \frac{\Delta H^\circ}{RT^2}$$

where ΔH° = standard enthalpy change of reaction

Thermodynamics

STEAM TABLES												
Saturated Water - Temperature Table												
Temp. °C <i>T</i>	Sat. Press. kPa <i>p_{sat}</i>	Specific Volume m ³ /kg		Internal Energy kJ/kg			Enthalpy kJ/kg			Entropy kJ/(kg·K)		
		Sat. liquid <i>v_f</i>	Sat. vapor <i>v_g</i>	Sat. liquid <i>u_f</i>	Evap. <i>u_{fg}</i>	Sat. vapor <i>u_g</i>	Sat. liquid <i>h_f</i>	Evap. <i>h_{fg}</i>	Sat. vapor <i>h_g</i>	Sat. liquid <i>s_f</i>	Evap. <i>s_{fg}</i>	Sat. vapor <i>s_g</i>
0.01	0.6113	0.001 000	206.14	0.00	2375.3	2375.3	0.01	2501.3	2501.4	0.0000	9.1562	9.1562
5	0.8721	0.001 000	147.12	20.97	2361.3	2382.3	20.98	2489.6	2510.6	0.0761	8.9496	9.0257
10	1.2276	0.001 000	106.38	42.00	2347.2	2389.2	42.01	2477.7	2519.8	0.1510	8.7498	8.9008
15	1.7051	0.001 001	77.93	62.99	2333.1	2396.1	62.99	2465.9	2528.9	0.2245	8.5569	8.7814
20	2.339	0.001 002	57.79	83.95	2319.0	2402.9	83.96	2454.1	2538.1	0.2966	8.3706	8.6672
25	3.169	0.001 003	43.36	104.88	2304.9	2409.8	104.89	2442.3	2547.2	0.3674	8.1905	8.5580
30	4.246	0.001 004	32.89	125.78	2290.8	2416.6	125.79	2430.5	2556.3	0.4369	8.0164	8.4533
35	5.628	0.001 006	25.22	146.67	2276.7	2423.4	146.68	2418.6	2565.3	0.5053	7.8478	8.3531
40	7.384	0.001 008	19.52	167.56	2262.6	2430.1	167.57	2406.7	2574.3	0.5725	7.6845	8.2570
45	9.593	0.001 010	15.26	188.44	2248.4	2436.8	188.45	2394.8	2583.2	0.6387	7.5261	8.1648
50	12.349	0.001 012	12.03	209.32	2234.2	2443.5	209.33	2382.7	2592.1	0.7038	7.3725	8.0763
55	15.758	0.001 015	9.568	230.21	2219.9	2450.1	230.22	2370.7	2600.9	0.7679	7.2234	7.9913
60	19.940	0.001 017	7.671	251.11	2205.5	2456.6	251.13	2358.5	2609.6	0.8312	7.0784	7.9096
65	25.03	0.001 020	6.197	272.02	2191.1	2463.1	272.06	2346.2	2618.3	0.8935	6.9375	7.8310
70	31.19	0.001 023	5.042	292.95	2176.6	2569.6	292.98	2333.8	2626.8	0.9549	6.8004	7.7553
75	38.58	0.001 026	4.131	313.90	2162.0	2475.9	313.93	2321.4	2635.3	1.0155	6.6669	7.6824
80	47.39	0.001 029	3.407	334.86	2147.4	2482.2	334.91	2308.8	2643.7	1.0753	6.5369	7.6122
85	57.83	0.001 033	2.828	355.84	2132.6	2488.4	355.90	2296.0	2651.9	1.1343	6.4102	7.5445
90	70.14	0.001 036	2.361	376.85	2117.7	2494.5	376.92	2283.2	2660.1	1.1925	6.2866	7.4791
95	84.55	0.001 040	1.982	397.88	2102.7	2500.6	397.96	2270.2	2668.1	1.2500	6.1659	7.4159
MPa												
100	0.101 35	0.001 044	1.6729	418.94	2087.6	2506.5	419.04	2257.0	2676.1	1.3069	6.0480	7.3549
105	0.120 82	0.001 048	1.4194	440.02	2072.3	2512.4	440.15	2243.7	2683.8	1.3630	5.9328	7.2958
110	0.143 27	0.001 052	1.2102	461.14	2057.0	2518.1	461.30	2230.2	2691.5	1.4185	5.8202	7.2387
115	0.169 06	0.001 056	1.0366	482.30	2041.4	2523.7	482.48	2216.5	2699.0	1.4734	5.7100	7.1833
120	0.198 53	0.001 060	0.8919	503.50	2025.8	2529.3	503.71	2202.6	2706.3	1.5276	5.6020	7.1296
125	0.2321	0.001 065	0.7706	524.74	2009.9	2534.6	524.99	2188.5	2713.5	1.5813	5.4962	7.0775
130	0.2701	0.001 070	0.6685	546.02	1993.9	2539.9	546.31	2174.2	2720.5	1.6344	5.3925	7.0269
135	0.3130	0.001 075	0.5822	567.35	1977.7	2545.0	567.69	2159.6	2727.3	1.6870	5.2907	6.9777
140	0.3613	0.001 080	0.5089	588.74	1961.3	2550.0	589.13	2144.7	2733.9	1.7391	5.1908	6.9299
145	0.4154	0.001 085	0.4463	610.18	1944.7	2554.9	610.63	2129.6	2740.3	1.7907	5.0926	6.8833
150	0.4758	0.001 091	0.3928	631.68	1927.9	2559.5	632.20	2114.3	2746.5	1.8428	4.9960	6.8379
155	0.5431	0.001 096	0.3468	653.24	1910.8	2564.1	653.84	2098.6	2752.4	1.8925	4.9010	6.7935
160	0.6178	0.001 102	0.3071	674.87	1893.5	2568.4	675.55	2082.6	2758.1	1.9427	4.8075	6.7502
165	0.7005	0.001 108	0.2727	696.56	1876.0	2572.5	697.34	2066.2	2763.5	1.9925	4.7153	6.7078
170	0.7917	0.001 114	0.2428	718.33	1858.1	2576.5	719.21	2049.5	2768.7	2.0419	4.6244	6.6663
175	0.8920	0.001 121	0.2168	740.17	1840.0	2580.2	741.17	2032.4	2773.6	2.0909	4.5347	6.6256
180	1.0021	0.001 127	0.194 05	762.09	1821.6	2583.7	763.22	2015.0	2778.2	2.1396	4.4461	6.5857
185	1.1227	0.001 134	0.174 09	784.10	1802.9	2587.0	785.37	1997.1	2782.4	2.1879	4.3586	6.5465
190	1.2544	0.001 141	0.156 54	806.19	1783.8	2590.0	807.62	1978.8	2786.4	2.2359	4.2720	6.5079
195	1.3978	0.001 149	0.141 05	828.37	1764.4	2592.8	829.98	1960.0	2790.0	2.2835	4.1863	6.4698
200	1.5538	0.001 157	0.127 36	850.65	1744.7	2595.3	852.45	1940.7	2793.2	2.3309	4.1014	6.4323
205	1.7230	0.001 164	0.115 21	873.04	1724.5	2597.5	875.04	1921.0	2796.0	2.3780	4.0172	6.3952
210	1.9062	0.001 173	0.104 41	895.53	1703.9	2599.5	897.76	1900.7	2798.5	2.4248	3.9337	6.3585
215	2.104	0.001 181	0.094 79	918.14	1682.9	2601.1	920.62	1879.9	2800.5	2.4714	3.8507	6.3221
220	2.318	0.001 190	0.086 19	940.87	1661.5	2602.4	943.62	1858.5	2802.1	2.5178	3.7683	6.2861
225	2.548	0.001 199	0.078 49	963.73	1639.6	2603.3	966.78	1836.5	2803.3	2.5639	3.6863	6.2503
230	2.795	0.001 209	0.071 58	986.74	1617.2	2603.9	990.12	1813.8	2804.0	2.6099	3.6047	6.2146
235	3.060	0.001 219	0.065 37	1009.89	1594.2	2604.1	1013.62	1790.5	2804.2	2.6558	3.5233	6.1791
240	3.344	0.001 229	0.059 76	1033.21	1570.8	2604.0	1037.32	1766.5	2803.8	2.7015	3.4422	6.1437
245	3.648	0.001 240	0.054 71	1056.71	1546.7	2603.4	1061.23	1741.7	2803.0	2.7472	3.3612	6.1083
250	3.973	0.001 251	0.050 13	1080.39	1522.0	2602.4	1085.36	1716.2	2801.5	2.7927	3.2802	6.0730
255	4.319	0.001 263	0.045 98	1104.28	1496.7	2600.9	1109.73	1689.8	2799.5	2.8383	3.1992	6.0375
260	4.688	0.001 276	0.042 21	1128.39	1470.6	2599.0	1134.37	1662.5	2796.9	2.8838	3.1181	6.0019
265	5.081	0.001 289	0.038 77	1152.74	1443.9	2596.6	1159.28	1634.4	2793.6	2.9294	3.0368	5.9662
270	5.499	0.001 302	0.035 64	1177.36	1416.3	2593.7	1184.51	1605.2	2789.7	2.9751	2.9551	5.9301
275	5.942	0.001 317	0.032 79	1202.25	1387.9	2590.2	1210.07	1574.9	2785.0	3.0208	2.8730	5.8938
280	6.412	0.001 332	0.030 17	1227.46	1358.7	2586.1	1235.99	1543.6	2779.6	3.0668	2.7903	5.8571
285	6.909	0.001 348	0.027 77	1253.00	1328.4	2581.4	1262.31	1511.0	2773.3	3.1130	2.7070	5.8199
290	7.436	0.001 366	0.025 57	1278.92	1297.1	2576.0	1289.07	1477.1	2766.2	3.1594	2.6227	5.7821
295	7.993	0.001 384	0.023 54	1305.2	1264.7	2569.9	1316.3	1441.8	2758.1	3.2062	2.5375	5.7437
300	8.581	0.001 404	0.021 67	1332.0	1231.0	2563.0	1344.0	1404.9	2749.0	3.2534	2.4511	5.7045
305	9.202	0.001 425	0.019 948	1359.3	1195.9	2555.2	1372.4	1366.4	2738.7	3.3010	2.3633	5.6643
310	9.856	0.001 447	0.018 350	1387.1	1159.4	2546.4	1401.3	1326.0	2727.3	3.3493	2.2737	5.6230
315	10.547	0.001 472	0.016 867	1415.5	1121.1	2536.6	1431.0	1283.5	2714.5	3.3982	2.1821	5.5804
320	11.274	0.001 499	0.015 488	1444.6	1080.9	2525.5	1461.5	1238.6	2700.1	3.4480	2.0882	5.5362
330	12.845	0.001 561	0.012 996	1505.3	993.7	2498.9	1525.3	1140.6	2665.9	3.5507	1.8909	5.4417
340	14.586	0.001 638	0.010 797	1570.3	894.3	2464.6	1594.2	1027.9	2622.0	3.6594	1.6763	5.3357
350	16.513	0.001 740	0.008 813	1641.9	776.6	2418.4	1670.6	893.4	2563.9	3.7777	1.4335	5.2112
360	18.651	0.001 893	0.006 945	1725.2	626.3	2351.5	1760.5	720.3	2481.0	3.9147	1.1379	5.0526
370	21.03	0.002 213	0.004 925	1844.0	384.5	2228.5	1890.5	441.6	2332.1	4.1106	0.6865	4.7971
374.14	22.09	0.003 155	0.003 155	2029.6	0	2029.6	2099.3	0	2099.3	4.4298	0	4.4298

Thermodynamics

Superheated Water Tables								
T Temp. °C	v m ³ /kg	u kJ/kg	h kJ/kg	s kJ/(kg·K)	v m ³ /kg	u kJ/kg	h kJ/kg	s kJ/(kg·K)
	$p = 0.01 \text{ MPa (45.81}^\circ\text{C)}$				$p = 0.05 \text{ MPa (81.33}^\circ\text{C)}$			
Sat.	14.674	2437.9	2584.7	8.1502	3.240	2483.9	2645.9	7.5939
50	14.869	2443.9	2592.6	8.1749				
100	17.196	2515.5	2687.5	8.4479	3.418	2511.6	2682.5	7.6947
150	19.512	2587.9	2783.0	8.6882	3.889	2585.6	2780.1	7.9401
200	21.825	2661.3	2879.5	8.9038	4.356	2659.9	2877.7	8.1580
250	24.136	2736.0	2977.3	9.1002	4.820	2735.0	2976.0	8.3556
300	26.445	2812.1	3076.5	9.2813	5.284	2811.3	3075.5	8.5373
400	31.063	2968.9	3279.6	9.6077	6.209	2968.5	3278.9	8.8642
500	35.679	3132.3	3489.1	9.8978	7.134	3132.0	3488.7	9.1546
600	40.295	3302.5	3705.4	10.1608	8.057	3302.2	3705.1	9.4178
700	44.911	3479.6	3928.7	10.4028	8.981	3479.4	3928.5	9.6599
800	49.526	3663.8	4159.0	10.6281	9.904	3663.6	4158.9	9.8852
900	54.141	3855.0	4396.4	10.8396	10.828	3854.9	4396.3	10.0967
1000	58.757	4053.0	4640.6	11.0393	11.751	4052.9	4640.5	10.2964
1100	63.372	4257.5	4891.2	11.2287	12.674	4257.4	4891.1	10.4859
1200	67.987	4467.9	5147.8	11.4091	13.597	4467.8	5147.7	10.6662
1300	72.602	4683.7	5409.7	11.5811	14.521	4683.6	5409.6	10.8382
	$p = 0.10 \text{ MPa (99.63}^\circ\text{C)}$				$p = 0.20 \text{ MPa (120.23}^\circ\text{C)}$			
Sat.	1.6940	2506.1	2675.5	7.3594	0.8857	2529.5	2706.7	7.1272
100	1.6958	2506.7	2676.2	7.3614				
150	1.9364	2582.8	2776.4	7.6134	0.9596	2576.9	2768.8	7.2795
200	2.172	2658.1	2875.3	7.8343	1.0803	2654.4	2870.5	7.5066
250	2.406	2733.7	2974.3	8.0333	1.1988	2731.2	2971.0	7.7086
300	2.639	2810.4	3074.3	8.2158	1.3162	2808.6	3071.8	7.8926
400	3.103	2967.9	3278.2	8.5435	1.5493	2966.7	3276.6	8.2218
500	3.565	3131.6	3488.1	8.8342	1.7814	3130.8	3487.1	8.5133
600	4.028	3301.9	3704.4	9.0976	2.013	3301.4	3704.0	8.7770
700	4.490	3479.2	3928.2	9.3398	2.244	3478.8	3927.6	9.0194
800	4.952	3663.5	4158.6	9.5652	2.475	3663.1	4158.2	9.2449
900	5.414	3854.8	4396.1	9.7767	2.705	3854.5	4395.8	9.4566
1000	5.875	4052.8	4640.3	9.9764	2.937	4052.5	4640.0	9.6563
1100	6.337	4257.3	4891.0	10.1659	3.168	4257.0	4890.7	9.8458
1200	6.799	4467.7	5147.6	10.3463	3.399	4467.5	5147.5	10.0262
1300	7.260	4683.5	5409.5	10.5183	3.630	4683.2	5409.3	10.1982
	$p = 0.40 \text{ MPa (143.63}^\circ\text{C)}$				$p = 0.60 \text{ MPa (158.85}^\circ\text{C)}$			
Sat.	0.4625	2553.6	2738.6	6.8959	0.3157	2567.4	2756.8	6.7600
150	0.4708	2564.5	2752.8	6.9299				
200	0.5342	2646.8	2860.5	7.1706	0.3520	2638.9	2850.1	6.9665
250	0.5951	2726.1	2964.2	7.3789	0.3938	2720.9	2957.2	7.1816
300	0.6548	2804.8	3066.8	7.5662	0.4344	2801.0	3061.6	7.3724
350	0.7137	2884.6	3170.1	7.7324	0.4742	2881.2	3165.7	7.5464
400	0.7726	2964.4	3273.4	7.8985	0.5137	2962.1	3270.3	7.7079
500	0.8893	3129.2	3484.9	8.1913	0.5920	3127.6	3482.8	8.0021
600	1.0055	3300.2	3702.4	8.4558	0.6697	3299.1	3700.9	8.2674
700	1.1215	3477.9	3926.5	8.6987	0.7472	3477.0	3925.3	8.5107
800	1.2372	3662.4	4157.3	8.9244	0.8245	3661.8	4156.5	8.7367
900	1.3529	3853.9	4395.1	9.1362	0.9017	3853.4	4394.4	8.9486
1000	1.4685	4052.0	4639.4	9.3360	0.9788	4051.5	4638.8	9.1485
1100	1.5840	4256.5	4890.2	9.5256	1.0559	4256.1	4889.6	9.3381
1200	1.6996	4467.0	5146.8	9.7060	1.1330	4466.5	5146.3	9.5185
1300	1.8151	4682.8	5408.8	9.8780	1.2101	4682.3	5408.3	9.6906
	$p = 0.80 \text{ MPa (170.43}^\circ\text{C)}$				$p = 1.00 \text{ MPa (179.91}^\circ\text{C)}$			
Sat.	0.2404	2576.8	2769.1	6.6628	0.194 44	2583.6	2778.1	6.5865
200	0.2608	2630.6	2839.3	6.8158	0.2060	2621.9	2827.9	6.6940
250	0.2931	2715.5	2950.0	7.0384	0.2327	2709.9	2942.6	6.9247
300	0.3241	2797.2	3056.5	7.2328	0.2579	2793.2	3051.2	7.1229
350	0.3544	2878.2	3161.7	7.4089	0.2825	2875.2	3157.7	7.3011
400	0.3843	2959.7	3267.1	7.5716	0.3066	2957.3	3263.9	7.4651
500	0.4433	3126.0	3480.6	7.8673	0.3541	3124.4	3478.5	7.7622
600	0.5018	3297.9	3699.4	8.1333	0.4011	3296.8	3697.9	8.0290
700	0.5601	3476.2	3924.2	8.3770	0.4478	3475.3	3923.1	8.2731
800	0.6181	3661.1	4155.6	8.6033	0.4943	3660.4	4154.7	8.4996
900	0.6761	3852.8	4393.7	8.8153	0.5407	3852.2	4392.9	8.7118
1000	0.7340	4051.0	4638.2	9.0153	0.5871	4050.5	4637.6	8.9119
1100	0.7919	4255.6	4889.2	9.2050	0.6335	4255.1	4888.6	9.1017
1200	0.8497	4466.1	5145.9	9.3855	0.6798	4465.6	5145.4	9.2822
1300	0.9076	4681.8	5407.9	9.5575	0.7261	4681.3	5407.4	9.4543

Mollier (h, s) Diagram for Steam

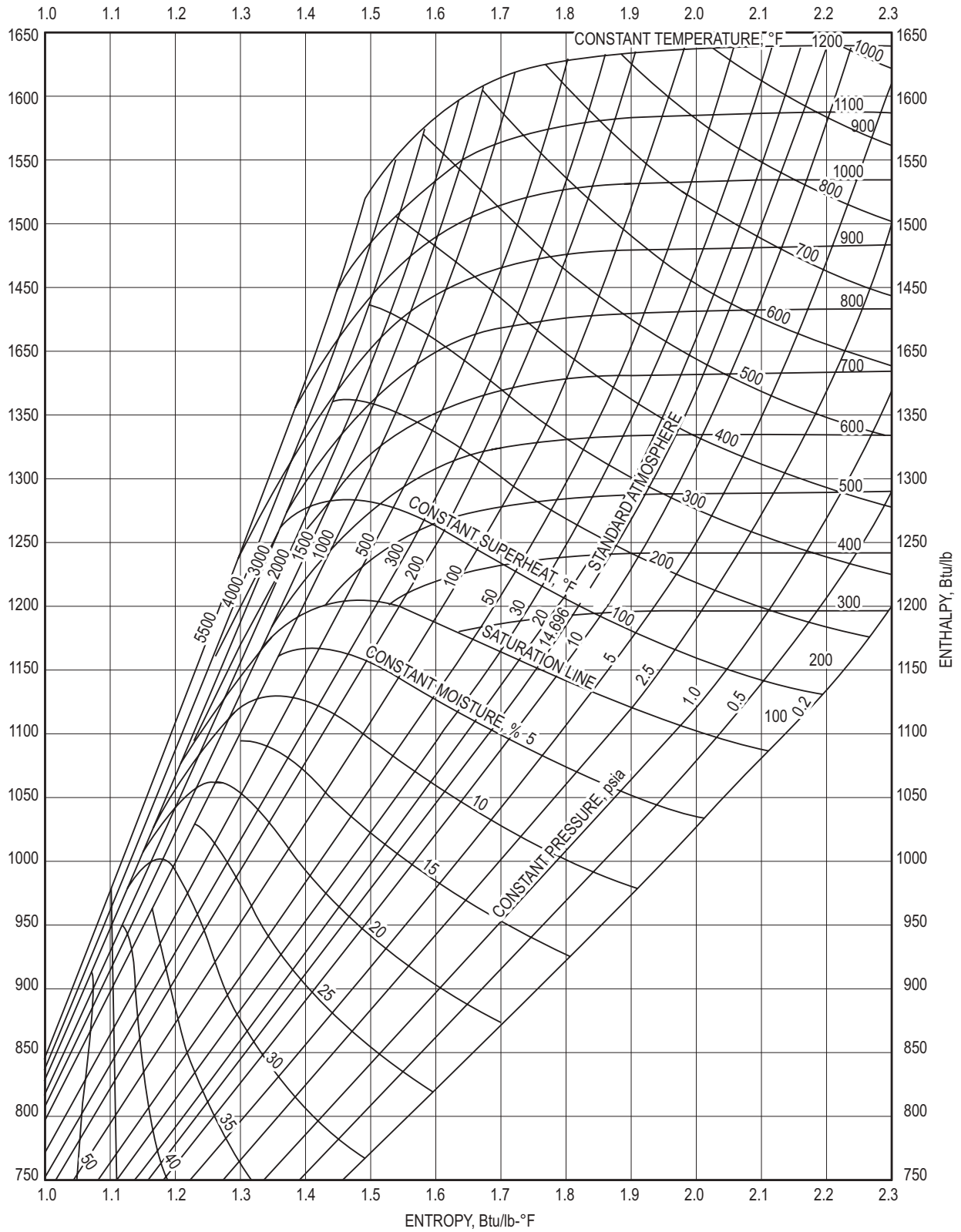

Howell, Ronald, H., William J. Coad, Harry J. Sauer, Jr., *Principles of Heating, Ventilating and Air Conditioning*, 6th ed., American Society of Heating, Refrigerating and Air-Conditioning Engineers, 2009, p. 21.

P-h Diagram for Refrigerant HFC-134a
(metric units)

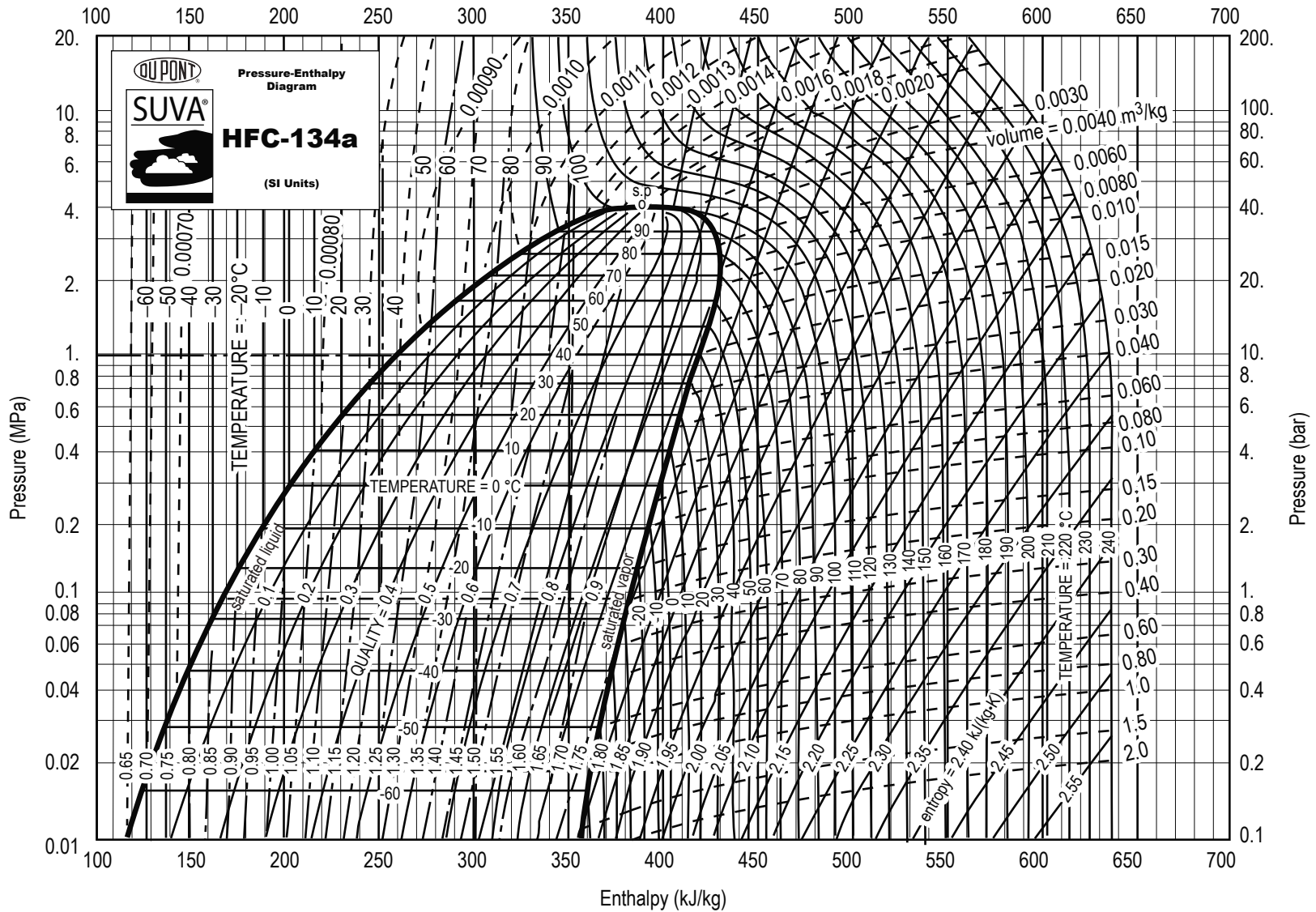

Data provided by DuPont Refrigerants, a division of E.I. duPont de Nemours and Co., Inc.

**Pressure Versus Enthalpy Curves for Refrigerant 134a
(USCS units)**

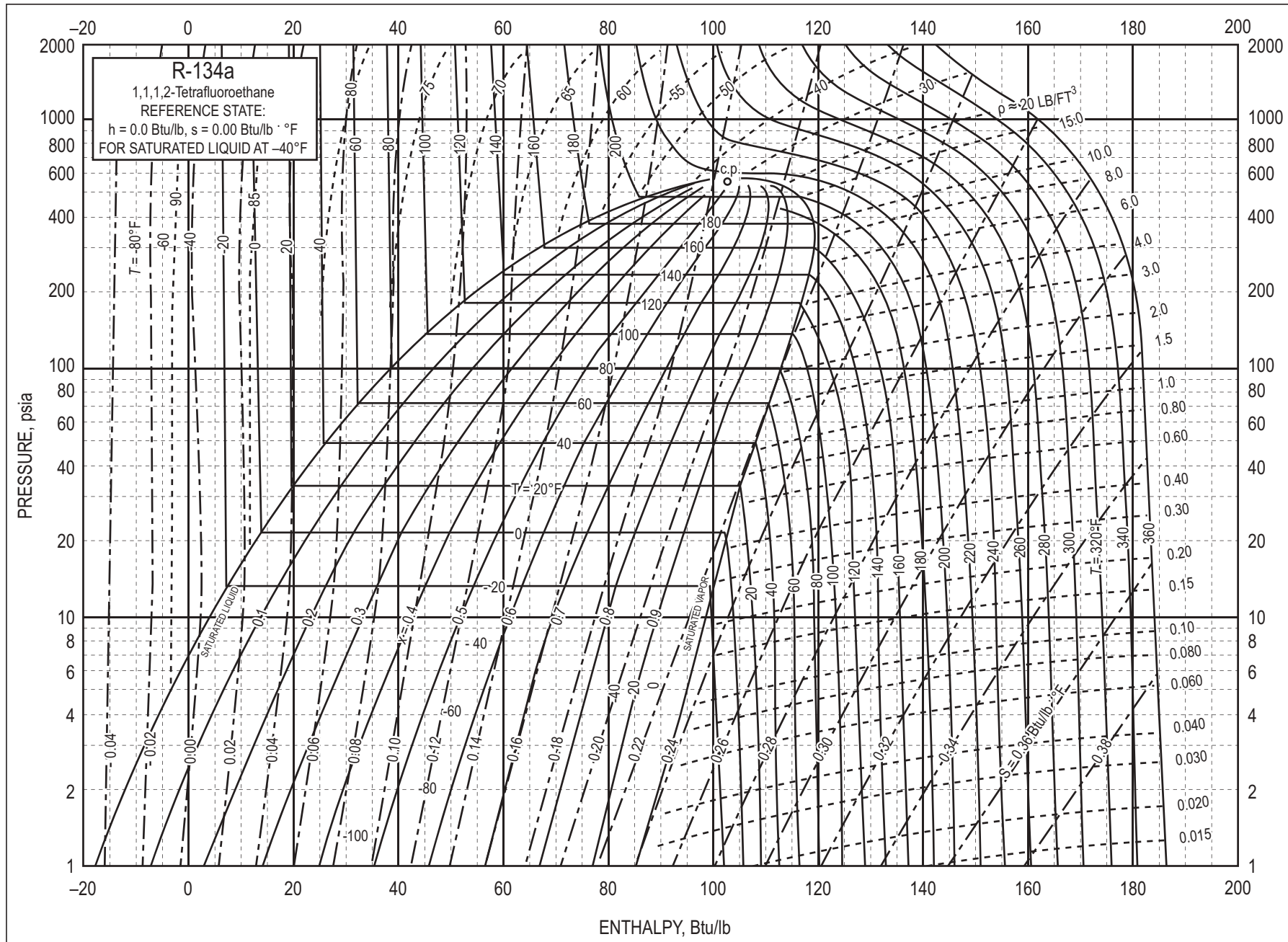

Refrigerant 134a (1,1,1,2-Tetrafluoroethane) Properties of Saturated Liquid and Saturated Vapor

Temp.,* °F	Pressure, psia	Density, lb/ft ³	Volume, ft ³ /lb	Enthalpy, Btu/lb-°F		Entropy, Btu/lb-°F		Specific Heat c _p Btu/lb-°F		C _p /C _v	Thermal Conductivity Btu/hr-ft-°F		Temp.,* °F
		Liquid	Vapor	Liquid	Vapor	Liquid	Vapor	Liquid	Vapor	Vapor	Liquid	Vapor	
-153.94 ^a	0.057	99.33	568.59	-32.992	80.362	-0.09154	0.27923	0.2829	0.1399	1.1637	0.0840	0.00178	-153.94 ^a
-150.00	0.072	98.97	452.12	-31.878	80.907	-0.08791	0.27629	0.2830	0.1411	1.1623	0.0832	0.00188	-150.00
-140.00	0.129	98.05	260.63	-29.046	82.304	-0.07891	0.26941	0.2834	0.1443	1.1589	0.0813	0.00214	-140.00
-130.00	0.221	97.13	156.50	-26.208	83.725	-0.07017	0.26329	0.2842	0.1475	1.1559	0.0794	0.00240	-130.00
-120.00	0.365	96.20	97.48	-23.360	85.168	-0.06166	0.25784	0.2853	0.1508	1.1532	0.0775	0.00265	-120.00
-110.00	0.583	95.27	62.763	-20.500	86.629	-0.05337	0.25300	0.2866	0.1540	1.1509	0.0757	0.00291	-110.00
-100.00	0.903	94.33	41.637	-17.626	88.107	-0.04527	0.24871	0.2881	0.1573	1.1490	0.0739	0.00317	-100.00
-90.00	1.359	93.38	28.381	-14.736	89.599	-0.03734	0.24490	0.2898	0.1607	1.1475	0.0722	0.00343	-90.00
-80.00	1.993	92.42	19.825	-11.829	91.103	-0.02959	0.24152	0.2916	0.1641	1.1465	0.0705	0.00369	-80.00
-75.00	2.392	91.94	16.711	-10.368	91.858	-0.02577	0.23998	0.2925	0.1658	1.1462	0.0696	0.00382	-75.00
-70.00	2.854	91.46	14.161	-8.903	92.614	-0.02198	0.23854	0.2935	0.1676	1.1460	0.0688	0.00395	-70.00
-65.00	3.389	90.97	12.060	-7.432	93.372	-0.01824	0.23718	0.2945	0.1694	1.1459	0.0680	0.00408	-65.00
-60.00	4.002	90.49	10.321	-5.957	94.131	-0.01452	0.23590	0.2955	0.1713	1.1460	0.0671	0.00420	-60.00
-55.00	4.703	90.00	8.873	-4.476	94.890	-0.01085	0.23470	0.2965	0.1731	1.1462	0.0663	0.00433	-55.00
-50.00	5.501	89.50	7.662	-2.989	95.650	-0.00720	0.23358	0.2976	0.1751	1.1466	0.0655	0.00446	-50.00
-45.00	6.406	89.00	6.6438	-1.498	96.409	-0.00358	0.23252	0.2987	0.1770	1.1471	0.0647	0.00460	-45.00
-40.00	7.427	88.50	5.7839	0.000	97.167	0.00000	0.23153	0.2999	0.1790	1.1478	0.0639	0.00473	-40.00
-35.00	8.576	88.00	5.0544	1.503	97.924	0.00356	0.23060	0.3010	0.1811	1.1486	0.0632	0.00486	-35.00
-30.00	9.862	87.49	4.4330	3.013	98.679	0.00708	0.22973	0.3022	0.1832	1.1496	0.0624	0.00499	-30.00
-25.00	11.299	86.98	3.9014	4.529	99.433	0.01058	0.22892	0.3035	0.1853	1.1508	0.0616	0.00512	-25.00
-20.00	12.898	86.47	3.4449	6.051	100.184	0.01406	0.22816	0.3047	0.1875	1.1521	0.0608	0.00525	-20.00
-15.00	14.671	85.95	3.0514	7.580	100.932	0.01751	0.22744	0.3060	0.1898	1.1537	0.0601	0.00538	-15.00
-14.93 ^b	14.696	85.94	3.0465	7.600	100.942	0.01755	0.22743	0.3061	0.1898	1.1537	0.0601	0.00538	-14.93 ^b
-10.00	16.632	85.43	2.7109	9.115	101.677	0.02093	0.22678	0.3074	0.1921	1.1554	0.0593	0.00552	-10.00
-5.00	18.794	84.90	2.4154	10.657	102.419	0.02433	0.22615	0.3088	0.1945	1.1573	0.0586	0.00565	-5.00

Refrigerant 134a (1,1,1,2-Tetrafluoroethane) Properties of Saturated Liquid and Saturated Vapor (cont'd)

Temp.,* °F	Pressure, psia	Density, lb/ft ³	Volume, ft ³ /lb	Enthalpy, Btu/lb-°F		Entropy, Btu/lb-°F		Specific Heat c _p Btu/lb-°F		C _p /C _v	Thermal Conductivity Btu/hr-ft-°F		Temp.,* °F
		Liquid	Vapor	Liquid	Vapor	Liquid	Vapor	Liquid	Vapor	Vapor	Liquid	Vapor	
0.00	21.171	84.37	2.1579	12.207	103.156	0.02771	0.22557	0.3102	0.1969	1.1595	0.0578	0.00578	0.00
5.00	23.777	83.83	1.9330	13.764	103.889	0.03107	0.22502	0.3117	0.1995	1.1619	0.0571	0.00592	5.00
10.00	26.628	83.29	1.7357	15.328	104.617	0.03440	0.22451	0.3132	0.2021	1.1645	0.0564	0.00605	10.00
15.00	29.739	82.74	1.5623	16.901	105.339	0.03772	0.22403	0.3147	0.2047	1.1674	0.0556	0.00619	15.00
20.00	33.124	82.19	1.4094	18.481	106.056	0.04101	0.22359	0.3164	0.2075	1.1705	0.0549	0.00632	20.00
25.00	36.800	81.63	1.2742	20.070	106.767	0.04429	0.22317	0.3181	0.2103	1.1740	0.0542	0.00646	25.00
30.00	40.784	81.06	1.1543	21.667	107.471	0.04755	0.22278	0.3198	0.2132	1.1777	0.0535	0.00660	30.00
35.00	45.092	80.49	1.0478	23.274	108.167	0.05079	0.22241	0.3216	0.2163	1.1818	0.0528	0.00674	35.00
40.00	49.741	79.90	0.9528	24.890	108.856	0.05402	0.22207	0.3235	0.2194	1.1862	0.0521	0.00688	40.00
45.00	54.749	79.32	0.8680	26.515	109.537	0.05724	0.22174	0.3255	0.2226	1.1910	0.0514	0.00703	45.00
50.00	60.134	78.72	0.7920	28.150	110.209	0.06044	0.22144	0.3275	0.2260	1.1961	0.0507	0.00717	50.00
55.00	65.913	78.11	0.7238	29.796	110.871	0.06362	0.22115	0.3297	0.2294	1.2018	0.0500	0.00732	55.00
60.00	72.105	77.50	0.6625	31.452	111.524	0.06680	0.22088	0.3319	0.2331	1.2079	0.0493	0.00747	60.00
65.00	78.729	76.87	0.6072	33.120	112.165	0.06996	0.22062	0.3343	0.2368	1.2145	0.0486	0.00762	65.00
70.00	85.805	76.24	0.5572	34.799	112.796	0.07311	0.22037	0.3368	0.2408	1.2217	0.0479	0.00777	70.00
75.00	93.351	75.59	0.5120	36.491	113.414	0.07626	0.22013	0.3394	0.2449	1.2296	0.0472	0.00793	75.00
80.00	101.390	74.94	0.4710	38.195	114.019	0.07939	0.21989	0.3422	0.2492	1.2382	0.0465	0.00809	80.00
85.00	109.930	74.27	0.4338	39.913	114.610	0.08252	0.21966	0.3451	0.2537	1.2475	0.0458	0.00825	85.00
90.00	119.010	73.58	0.3999	41.645	115.186	0.08565	0.21944	0.3482	0.2585	1.2578	0.0451	0.00842	90.00
95.00	128.650	72.88	0.3690	43.392	115.746	0.08877	0.21921	0.3515	0.2636	1.2690	0.0444	0.00860	95.00
100.00	138.850	72.17	0.3407	45.155	116.289	0.09188	0.21898	0.3551	0.2690	1.2813	0.0437	0.00878	100.00
105.00	149.650	71.44	0.3148	46.934	116.813	0.09500	0.21875	0.3589	0.2747	1.2950	0.0431	0.00897	105.00
110.00	161.070	70.69	0.2911	48.731	117.317	0.09811	0.21851	0.3630	0.2809	1.3101	0.0424	0.00916	110.00
115.00	173.140	69.93	0.2693	50.546	117.799	0.10123	0.21826	0.3675	0.2875	1.3268	0.0417	0.00936	115.00
120.00	185.860	69.14	0.2493	52.382	118.258	0.10435	0.21800	0.3723	0.2948	1.3456	0.0410	0.00958	120.00

Refrigerant 134a (1,1,1,2-Tetrafluoroethane) Properties of Saturated Liquid and Saturated Vapor (cont'd)

Temp.,* °F	Pressure, psia	Density, lb/ft ³	Volume, ft ³ /lb	Enthalpy, Btu/lb-°F		Entropy, Btu/lb-°F		Specific Heat c _p Btu/lb-°F		C _p /C _v	Thermal Conductivity Btu/hr-ft-°F		Temp.,* °F
		Liquid	Vapor	Liquid	Vapor	Liquid	Vapor	Liquid	Vapor	Vapor	Liquid	Vapor	
125.00	199.280	68.32	0.2308	54.239	118.690	0.10748	0.21772	0.3775	0.3026	1.3666	0.0403	0.00981	125.00
130.00	213.410	67.49	0.2137	56.119	119.095	0.11062	0.21742	0.3833	0.3112	1.3903	0.0396	0.01005	130.00
135.00	228.280	66.62	0.1980	58.023	119.468	0.11376	0.21709	0.3897	0.3208	1.4173	0.0389	0.01031	135.00
140.00	243.920	65.73	0.1833	59.954	119.807	0.11692	0.21673	0.3968	0.3315	1.4481	0.0382	0.01058	140.00
145.00	260.360	64.80	0.1697	61.915	120.108	0.12010	0.21634	0.4048	0.3435	1.4837	0.0375	0.01089	145.00
150.00	277.610	63.83	0.1571	63.908	120.366	0.12330	0.21591	0.4138	0.3571	1.5250	0.0368	0.01122	150.00
155.00	295.730	62.82	0.1453	65.936	120.576	0.12653	0.21542	0.4242	0.3729	1.5738	0.0361	0.01158	155.00
160.00	314.730	61.76	0.1343	68.005	120.731	0.12979	0.21488	0.4362	0.3914	1.6318	0.0354	0.01199	160.00
165.00	334.650	60.65	0.1239	70.118	120.823	0.13309	0.21426	0.4504	0.4133	1.7022	0.0346	0.01245	165.00
170.00	355.530	59.47	0.1142	72.283	120.842	0.13644	0.21356	0.4675	0.4400	1.7889	0.0339	0.01297	170.00
175.00	377.410	58.21	0.1051	74.509	120.773	0.13985	0.21274	0.4887	0.4733	1.8984	0.0332	0.01358	175.00
180.00	400.340	56.86	0.0964	76.807	120.598	0.14334	0.21180	0.5156	0.5159	2.0405	0.0325	0.01430	180.00
185.00	424.360	55.38	0.0881	79.193	120.294	0.14693	0.21069	0.5512	0.5729	2.2321	0.0318	0.01516	185.00
190.00	449.520	53.76	0.0801	81.692	119.822	0.15066	0.20935	0.6012	0.6532	2.5041	0.0311	0.01623	190.00
195.00	475.910	51.91	0.0724	84.343	119.123	0.15459	0.20771	0.6768	0.7751	2.9192	0.0304	0.01760	195.00
200.00	503.590	49.76	0.0647	87.214	118.097	0.15880	0.20562	0.8062	0.9835	3.6309	0.0300	0.01949	200.00
205.00	532.680	47.08	0.0567	90.454	116.526	0.16353	0.20275	1.0830	1.4250	5.1360	0.0300	0.02240	205.00
210.00	563.350	43.20	0.0477	94.530	113.746	0.16945	0.19814	2.1130	3.0080	10.5120	0.0316	0.02848	210.00
213.91 ^c	588.750	31.96	0.0313	103.894	103.894	0.18320	0.18320	∞	∞	∞	∞	∞	213.91 ^c

* Temperature on ITS-90 scale ^a Triple point ^b Normal boiling point ^c Critical point

Reprinted with permission from 2013 ASHRAE Handbook — Fundamentals, ASHRAE: 2013.

**Pressure Versus Enthalpy Curves for Refrigerant 410A
(USCS units)**

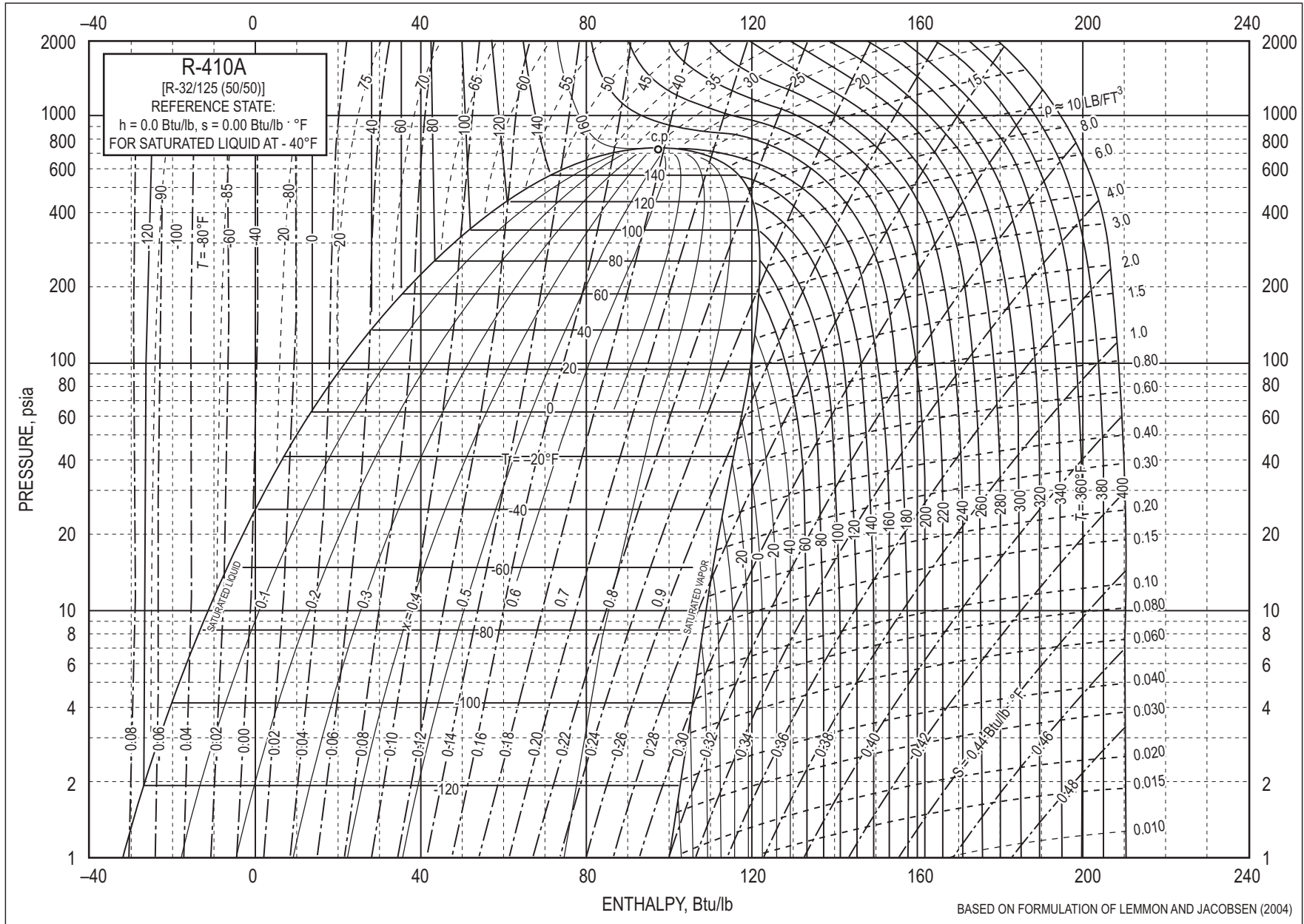

165

Thermodynamics

Refrigerant 410A [R-32/125 (50/50)] Properties of Liquid on Bubble Line and Vapor on Dew Line

Pressure, psia	Temp., * °F		Density, lb/ft ³	Volume, ft ³ /lb	Enthalpy, Btu/lb-°F		Entropy, Btu/lb-°F		Specific Heat c _p Btu/lb-°F		C _p /C _v	Thermal Conductivity Btu/hr-ft-°F		Pressure, psia
	Bubble	Dew	Liquid	Vapor	Liquid	Vapor	Liquid	Vapor	Liquid	Vapor	Vapor	Liquid	Vapor	
1	-135.16	-134.98	92.02	47.6458	-30.90	100.62	-0.08330	0.32188	0.3215	0.1568	1.228	0.1043	0.00421	1
1.5	-126.03	-125.87	91.10	32.5774	-27.97	101.90	-0.07439	0.31477	0.3212	0.1600	1.227	0.1023	0.00431	1.5
2	-119.18	-119.02	90.41	24.8810	-25.76	102.86	-0.06786	0.30981	0.3213	0.1626	1.227	0.1008	0.00439	2
2.5	-113.63	-113.48	89.84	20.1891	-23.98	103.63	-0.06267	0.30602	0.3214	0.1648	1.228	0.0996	0.00446	2.5
3	-108.94	-108.78	89.36	17.0211	-22.47	104.27	-0.05834	0.30296	0.3216	0.1668	1.228	0.0985	0.00451	3
4	-101.22	-101.07	88.57	13.0027	-19.98	105.33	-0.05133	0.29820	0.3221	0.1703	1.229	0.0968	0.00461	4
5	-94.94	-94.80	87.92	10.5514	-17.96	106.18	-0.04574	0.29455	0.3226	0.1733	1.230	0.0954	0.00469	5
6	-89.63	-89.48	87.36	8.8953	-16.24	106.89	-0.04107	0.29162	0.3231	0.1760	1.232	0.0942	0.00476	6
7	-84.98	-84.84	86.87	7.6992	-14.74	107.50	-0.03704	0.28916	0.3236	0.1785	1.233	0.0931	0.00482	7
8	-80.85	-80.71	86.44	6.7935	-13.40	108.05	-0.03349	0.28705	0.3241	0.1807	1.234	0.0922	0.00488	8
10	-73.70	-73.56	85.67	5.5105	-11.08	108.97	-0.02743	0.28356	0.3251	0.1848	1.237	0.0905	0.00498	10
12	-67.62	-67.48	85.02	4.6434	-9.10	109.75	-0.02235	0.28075	0.3261	0.1884	1.240	0.0891	0.00507	12
14	-62.31	-62.16	84.44	4.0168	-7.36	110.42	-0.01795	0.27840	0.3270	0.1917	1.243	0.0879	0.00515	14
14.70 ^b	-60.60	-60.46	84.26	3.8375	-6.80	110.63	-0.01655	0.27766	0.3274	0.1928	1.244	0.0875	0.00517	14.70 ^b
16	-57.56	-57.42	83.93	3.5423	-5.80	111.01	-0.01407	0.27638	0.3279	0.1947	1.245	0.0868	0.00522	16
18	-53.27	-53.13	83.45	3.1699	-4.39	111.54	-0.01059	0.27461	0.3288	0.1975	1.248	0.0858	0.00528	18
20	-49.34	-49.19	83.02	2.8698	-3.09	112.01	-0.00743	0.27305	0.3297	0.2002	1.251	0.0849	0.00535	20
22	-45.70	-45.56	82.61	2.6225	-1.89	112.45	-0.00452	0.27164	0.3305	0.2027	1.254	0.0841	0.00540	22
24	-42.32	-42.18	82.23	2.4151	-0.77	112.85	-0.00184	0.27036	0.3313	0.2050	1.256	0.0833	0.00546	24
26	-39.15	-39.01	81.87	2.2386	0.28	113.22	0.0007	0.26919	0.3321	0.2073	1.259	0.0826	0.00551	26
28	-36.17	-36.02	81.54	2.0865	1.27	113.56	0.0030	0.26811	0.3329	0.2094	1.261	0.0819	0.00556	28
30	-33.35	-33.20	81.21	1.9540	2.22	113.88	0.0052	0.26711	0.3337	0.2115	1.264	0.0813	0.00561	30
32	-30.68	-30.53	80.90	1.8375	3.11	114.19	0.0073	0.26617	0.3345	0.2135	1.267	0.0806	0.00565	32
34	-28.13	-27.98	80.61	1.7343	3.97	114.47	0.0093	0.26530	0.3352	0.2154	1.269	0.0801	0.00570	34
36	-25.69	-25.54	80.33	1.6422	4.79	114.74	0.0112	0.26448	0.3360	0.2173	1.272	0.0795	0.00574	36

Refrigerant 410A [R-32/125 (50/50)] Properties of Liquid on Bubble Line and Vapor on Dew Line (con't)

Pressure, psia	Temp., * °F		Density, lb/ft ³	Volume, ft ³ /lb	Enthalpy, Btu/lb-°F		Entropy, Btu/lb-°F		Specific Heat c _p Btu/lb-°F		C _p /C _v	Thermal Conductivity Btu/hr-ft-°F		Pressure, psia
	Bubble	Dew	Liquid	Vapor	Liquid	Vapor	Liquid	Vapor	Liquid	Vapor	Vapor	Liquid	Vapor	
38	-23.36	-23.20	80.05	1.5594	5.57	115.00	0.0130	0.26371	0.3367	0.2191	1.274	0.0790	0.00578	38
40	-21.12	-20.96	79.79	1.4847	6.33	115.24	0.0147	0.26297	0.3374	0.2208	1.277	0.0785	0.00582	40
42	-18.96	-18.81	79.54	1.4168	7.06	115.47	0.0163	0.26228	0.3382	0.2226	1.279	0.0780	0.00586	42
44	-16.89	-16.73	79.29	1.3549	7.76	115.69	0.0179	0.26162	0.3389	0.2242	1.282	0.0775	0.00589	44
46	-14.88	-14.73	79.05	1.2982	8.45	115.90	0.0194	0.26098	0.3396	0.2259	1.284	0.0771	0.00593	46
48	-12.94	-12.79	78.82	1.2460	9.11	116.10	0.0209	0.26038	0.3403	0.2275	1.287	0.0766	0.00597	48
50	-11.07	-10.91	78.59	1.1979	9.75	116.30	0.0223	0.25980	0.3410	0.2290	1.289	0.0762	0.00600	50
55	-6.62	-6.45	78.05	1.0925	11.27	116.75	0.0257	0.25845	0.3427	0.2328	1.295	0.0752	0.00610	55
60	-2.46	-2.30	77.54	1.0040	12.70	117.16	0.0288	0.25722	0.3445	0.2365	1.301	0.0743	0.00619	60
65	1.43	1.60	77.06	0.9287	14.05	117.53	0.0317	0.25610	0.3462	0.2400	1.308	0.0734	0.00628	65
70	5.10	5.27	76.60	0.8638	15.33	117.88	0.0344	0.25505	0.3478	0.2434	1.314	0.0726	0.00636	70
75	8.58	8.75	76.15	0.8073	16.54	118.20	0.0370	0.25408	0.3495	0.2467	1.320	0.0719	0.00645	75
80	11.88	12.06	75.73	0.7576	17.70	118.49	0.0395	0.25316	0.3512	0.2499	1.326	0.0711	0.00653	80
85	15.03	15.21	75.32	0.7135	18.81	118.77	0.0418	0.25231	0.3528	0.2531	1.333	0.0704	0.00661	85
90	18.05	18.22	74.93	0.6742	19.88	119.02	0.0440	0.25149	0.3545	0.2562	1.339	0.0698	0.00669	90
95	20.93	21.11	74.54	0.6389	20.91	119.26	0.0461	0.25072	0.3561	0.2592	1.345	0.0692	0.00677	95
100	23.71	23.89	74.17	0.6070	21.90	119.48	0.0482	0.24999	0.3578	0.2622	1.352	0.0685	0.00684	100
110	28.96	29.14	73.46	0.5515	23.79	119.89	0.0520	0.24862	0.3611	0.2681	1.365	0.0674	0.00700	110
120	33.86	34.05	72.78	0.5051	25.57	120.24	0.0556	0.24736	0.3644	0.2738	1.378	0.0664	0.00715	120
130	38.46	38.65	72.13	0.4655	27.25	120.56	0.0589	0.24618	0.3678	0.2795	1.392	0.0654	0.00730	130
140	42.80	42.99	71.51	0.4314	28.85	120.83	0.0621	0.24508	0.3712	0.2852	1.406	0.0645	0.00745	140
150	46.91	47.11	70.90	0.4016	30.38	121.08	0.0650	0.24403	0.3746	0.2908	1.420	0.0636	0.00760	150
160	50.82	51.02	70.32	0.3755	31.85	121.29	0.0679	0.24304	0.3781	0.2965	1.435	0.0628	0.00775	160
170	54.56	54.76	69.75	0.3523	33.27	121.48	0.0706	0.24210	0.3816	0.3022	1.451	0.0620	0.00791	170
180	58.13	58.33	69.20	0.3316	34.63	121.65	0.0732	0.24119	0.3851	0.3080	1.467	0.0612	0.00807	180

Refrigerant 410A [R-32/125 (50/50)] Properties of Liquid on Bubble Line and Vapor on Dew Line (con't)

Pressure, psia	Temp., * °F		Density, lb/ft ³	Volume, ft ³ /lb	Enthalpy, Btu/lb-°F		Entropy, Btu/lb-°F		Specific Heat c _p Btu/lb-°F		C _p /C _v	Thermal Conductivity Btu/hr-ft-°F		Pressure, psia
	Bubble	Dew	Liquid	Vapor	Liquid	Vapor	Liquid	Vapor	Liquid	Vapor	Vapor	Liquid	Vapor	
190	61.55	61.76	68.66	0.3130	35.95	121.79	0.0757	0.24031	0.3888	0.3139	1.483	0.0605	0.00823	190
200	64.84	65.05	68.13	0.2962	37.22	121.91	0.0780	0.23946	0.3925	0.3200	1.500	0.0598	0.00839	200
220	71.07	71.28	67.10	0.2669	39.67	122.09	0.0826	0.23783	0.4001	0.3325	1.537	0.0585	0.00873	220
240	76.89	77.10	66.11	0.2424	41.99	122.20	0.0868	0.23628	0.4081	0.3457	1.576	0.0573	0.00908	240
260	82.35	82.57	65.14	0.2215	44.21	122.25	0.0908	0.23478	0.4165	0.3599	1.619	0.0562	0.00945	260
280	87.51	87.73	64.19	0.2034	46.34	122.24	0.0946	0.23333	0.4255	0.3751	1.665	0.0552	0.00983	280
300	92.40	92.61	63.26	0.1876	48.40	122.18	0.0983	0.23190	0.4350	0.3915	1.716	0.0542	0.01024	300
320	97.04	97.26	62.34	0.1736	50.38	122.07	0.1018	0.23049	0.4452	0.4094	1.772	0.0533	0.01067	320
340	101.48	101.69	61.42	0.1613	52.31	121.91	0.1051	0.22909	0.4564	0.4290	1.833	0.0524	0.01113	340
360	105.71	105.93	60.52	0.1501	54.19	121.70	0.1083	0.22769	0.4685	0.4507	1.901	0.0515	0.01162	360
380	109.78	109.99	59.61	0.1401	56.03	121.44	0.1115	0.22629	0.4820	0.4747	1.977	0.0507	0.01214	380
400	113.68	113.89	58.70	0.1310	57.83	121.13	0.1145	0.22488	0.4971	0.5016	2.063	0.0499	0.01271	400
450	122.82	123.01	56.39	0.1114	62.23	120.14	0.1218	0.22124	0.5443	0.5857	2.333	0.0481	0.01433	450
500	131.19	131.38	53.97	0.0952	66.54	118.80	0.1289	0.21732	0.6143	0.7083	2.728	0.0465	0.01636	500
550	138.93	139.09	51.32	0.0814	70.89	117.02	0.1359	0.21295	0.7303	0.9059	3.367	0.0451	0.01902	550
600	146.12	146.25	48.24	0.0690	75.47	114.59	0.1432	0.20777	0.9603	1.2829	4.579	0.0440	0.02275	600
692.78 ^c	158.40	158.40	34.18	0.0293	90.97	90.97	0.1678	0.16781	—	—	—	—	—	692.78 ^c

* Temperature on ITS-90 scale

^b Bubble and dew point at one standard atmosphere

^c Critical point

Reprinted with permission from 2013 ASHRAE Handbook — Fundamentals, ASHRAE: 2013.

Thermodynamics

Thermal and Physical Property Tables (at room temperature)

GASES								
Substance	Mol wt	c_p		c_v		k	R	
		kJ/(kg·K)	Btu/(lbm·°R)	kJ/(kg·K)	Btu/(lbm·°R)		kJ/(kg·K)	ft·lbf/(lbm·°R)
Gases								
Air	29	1.00	0.240	0.718	0.171	1.40	0.2870	53.34
Argon	40	0.520	0.125	0.312	0.0756	1.67	0.2081	38.68
Butane	58	1.72	0.415	1.57	0.381	1.09	0.1430	26.58
Carbon dioxide	44	0.846	0.203	0.657	0.158	1.29	0.1889	35.10
Carbon monoxide	28	1.04	0.249	0.744	0.178	1.40	0.2968	55.16
Ethane	30	1.77	0.427	1.49	0.361	1.18	0.2765	51.38
Helium	4	5.19	1.25	3.12	0.753	1.67	2.0769	386.0
Hydrogen	2	14.3	3.43	10.2	2.44	1.40	4.1240	766.4
Methane	16	2.25	0.532	1.74	0.403	1.30	0.5182	96.35
Neon	20	1.03	0.246	0.618	0.148	1.67	0.4119	76.55
Nitrogen	28	1.04	0.248	0.743	0.177	1.40	0.2968	55.15
Octane vapor	114	1.71	0.409	1.64	0.392	1.04	0.0729	13.53
Oxygen	32	0.918	0.219	0.658	0.157	1.40	0.2598	48.28
Propane	44	1.68	0.407	1.49	0.362	1.12	0.1885	35.04
Steam	18	1.87	0.445	1.41	0.335	1.33	0.4615	85.76

GASES						
Substance	Critical Temperature, T_{cr}		Critical Pressure, P_{cr}		Critical Volume, V_{cr}	
	K	°R	MPa	atm	m ³ /kmol	ft ³ /lbmol
Air	132.5	238.5	3.77	37.2	—	—
Argon	150.8	271.4	4.87	48.1	0.0749	1.20
Butane	425.0	765.4	3.80	37.5	0.255	4.08
Carbon dioxide	304.1	547.4	7.38	72.8	0.0939	1.50
Carbon monoxide	132.9	239.2	3.50	34.5	0.09325	1.49
Ethane	305.4	549.7	4.88	48.2	0.1483	2.376
Helium	5.19	9.34	0.227	2.24	0.0574	0.9195
Hydrogen	33.2	59.8	1.30	12.8	0.0651	1.043
Methane	190.4	342.7	4.60	45.4	0.0992	1.59
Neon	44.4	79.9	2.76	27.2	0.0416	0.666
Nitrogen	126.2	227.2	3.39	33.5	0.0898	1.44
Octane vapor	568.8	1024.0	2.49	24.6	0.492	7.88
Oxygen	154.6	278.3	5.04	49.7	0.0734	1.18
Propane	369.8	665.6	4.25	41.9	0.203	3.25
Steam	647.1	1165.0	22.06	217.7	0.0560	0.8971

Howell, John R., and Richard O. Buckius, *Fundamentals of Engineering Thermodynamics*, 2nd ed., 1992, McGraw Hill, adapted from Table C.4 Critical Constants, pp. 870-872.

SELECTED LIQUIDS AND SOLIDS				
Substance	c_p		Density	
	kJ/(kg·K)	Btu/(lbm·°R)	kg/m ³	lbm/ft ³
Liquids				
Ammonia	4.80	1.146	602	38
Mercury	0.139	0.033	13,560	847
Water	4.18	1.000	997	62.4
Solids				
Aluminum	0.900	0.215	2,700	170
Copper	0.386	0.092	8,900	555
Ice (0°C; 32°F)	2.11	0.502	917	57.2
Iron	0.450	0.107	7,840	490
Lead	0.128	0.030	11,310	705

Howell, John, R. and Richard O. Bukins, *Fundamentals of Engineering Thermodynamics*, 2nd ed., McGraw-Hill, 1992, p. 896.

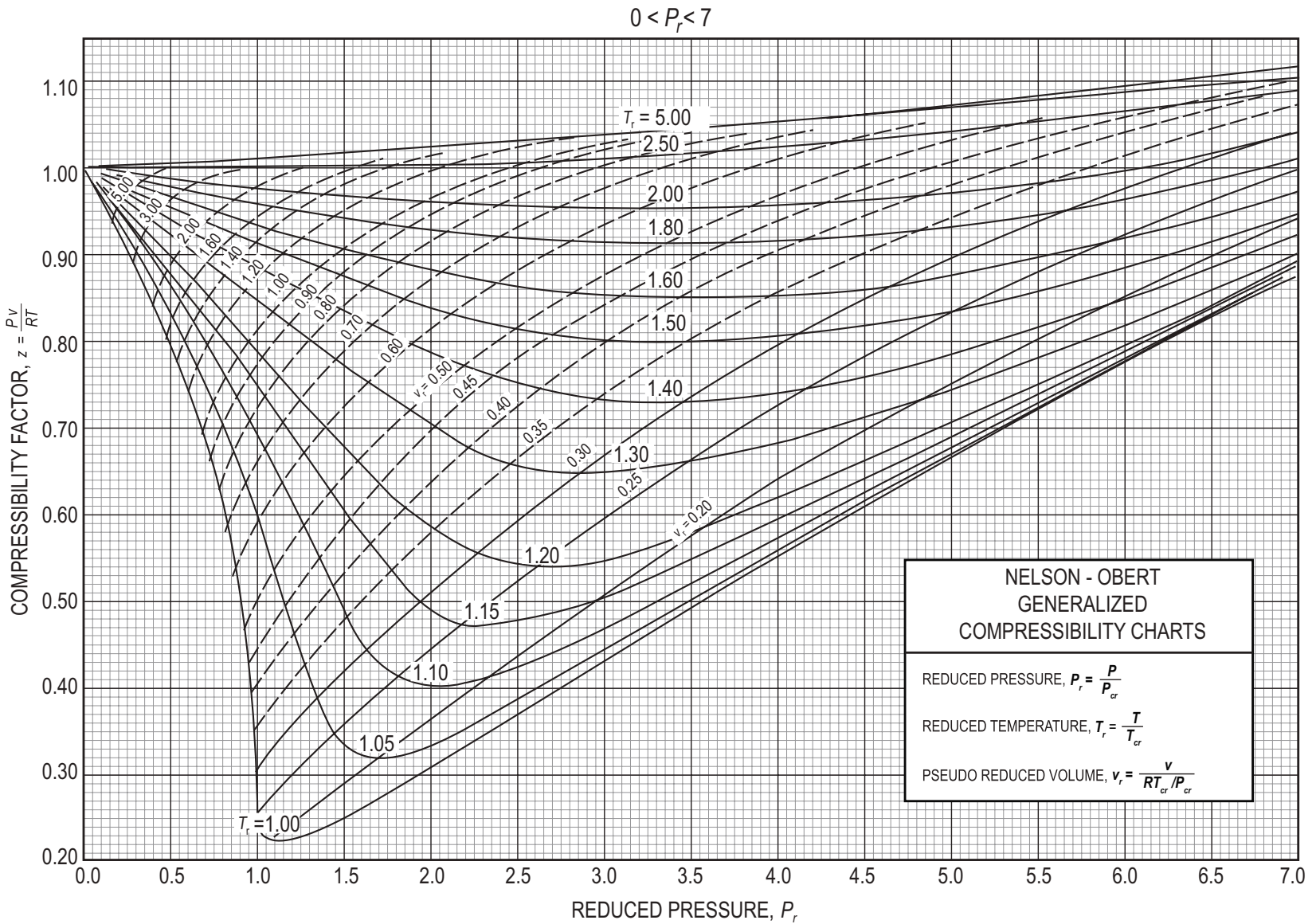

Definition of Compressibility Factor

The compressibility factor z is the ratio of the volume actually occupied by a gas at given temperature and pressure to the volume the gas would occupy if it behaved like an ideal gas at the same temperature and pressure. The compressibility factor is not a constant but varies with changes in gas composition, temperature, and pressure. It must be determined experimentally.

$$z = \frac{V_{\text{actual}}}{V_{\text{ideal}}}$$

COMMON THERMODYNAMIC CYCLES

Carnot Cycle

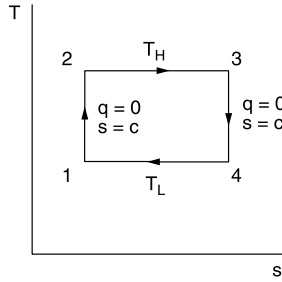
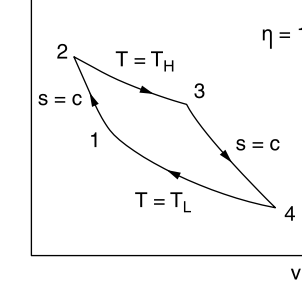

Reversed Carnot

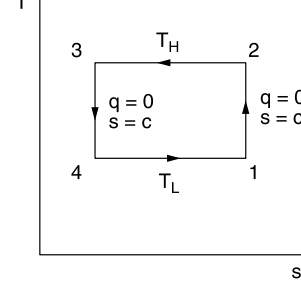

Otto Cycle
(Gasoline Engine)

$$\eta = 1 - r^{1-k}$$

$$r = v_1/v_2$$

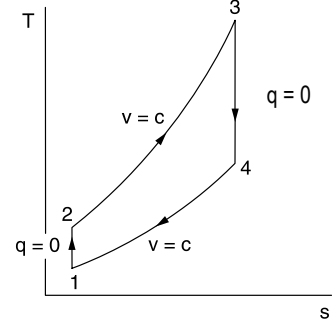
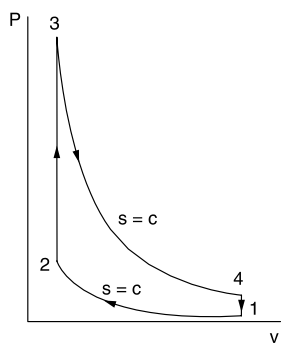

Rankine Cycle

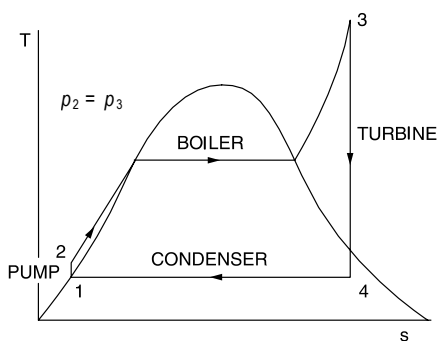
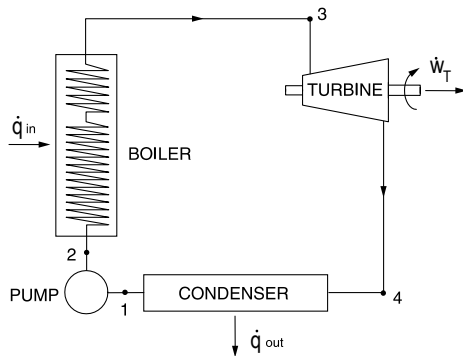

$$\eta = \frac{(h_3 - h_4) - (h_2 - h_1)}{h_3 - h_2}$$

Refrigeration

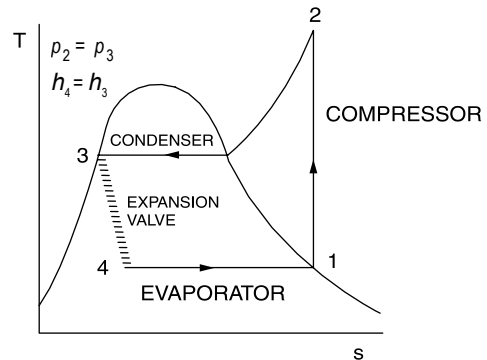
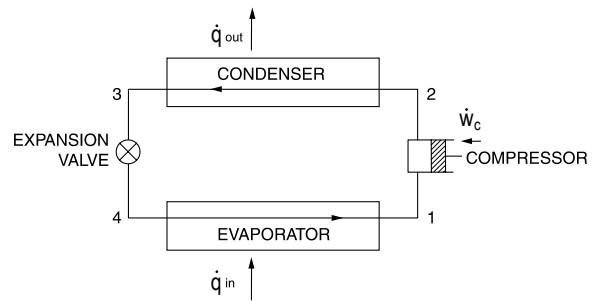

$$COP_{ref} = \frac{h_1 - h_4}{h_2 - h_1}$$

$$COP_{HP} = \frac{h_2 - h_3}{h_2 - h_1}$$

Refrigeration and HVAC

Cycles

Refrigeration and HVAC

Two-Stage Cycle

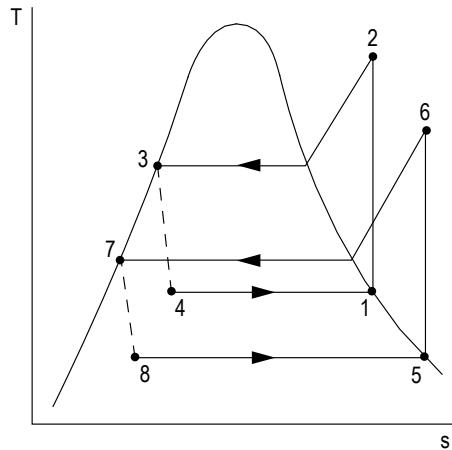
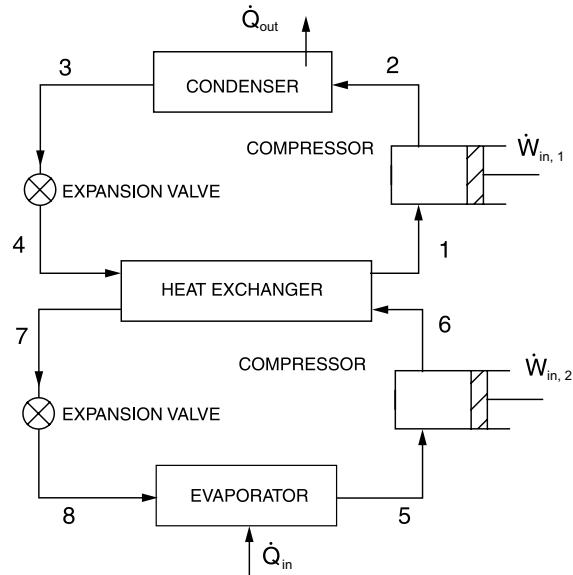

The following equations are valid if the mass flows are the same in each stage.

$$COP_{ref} = \frac{\dot{Q}_{in}}{\dot{W}_{in,1} + \dot{W}_{in,2}} = \frac{h_5 - h_8}{h_2 - h_1 + h_6 - h_5}$$

$$COP_{HP} = \frac{\dot{Q}_{out}}{\dot{W}_{in,1} + \dot{W}_{in,2}} = \frac{h_2 - h_3}{h_2 - h_1 + h_6 - h_5}$$

Air Refrigeration Cycle

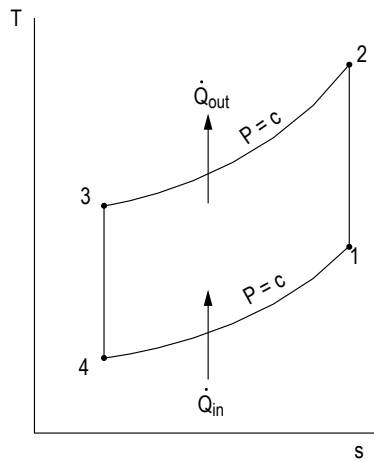
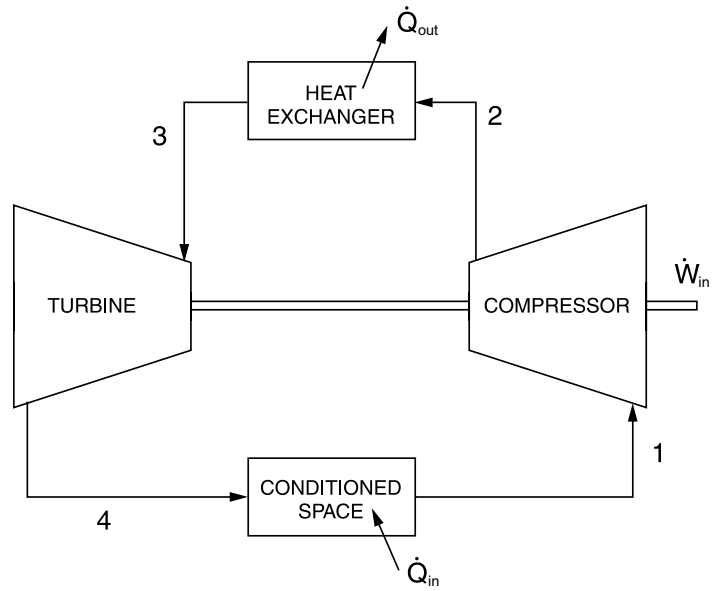

$$COP_{ref} = \frac{h_1 - h_4}{(h_2 - h_1) - (h_3 - h_4)}$$

$$COP_{HP} = \frac{h_2 - h_3}{(h_2 - h_1) - (h_3 - h_4)}$$



ASHRAE PSYCHROMETRIC CHART NO.1

NORMAL TEMPERATURE

BAROMETRIC PRESSURE: 101.325 kPa

Copyright 1992

AMERICAN SOCIETY OF HEATING, REFRIGERATING AND AIR-CONDITIONING ENGINEERS, INC.



SEA LEVEL

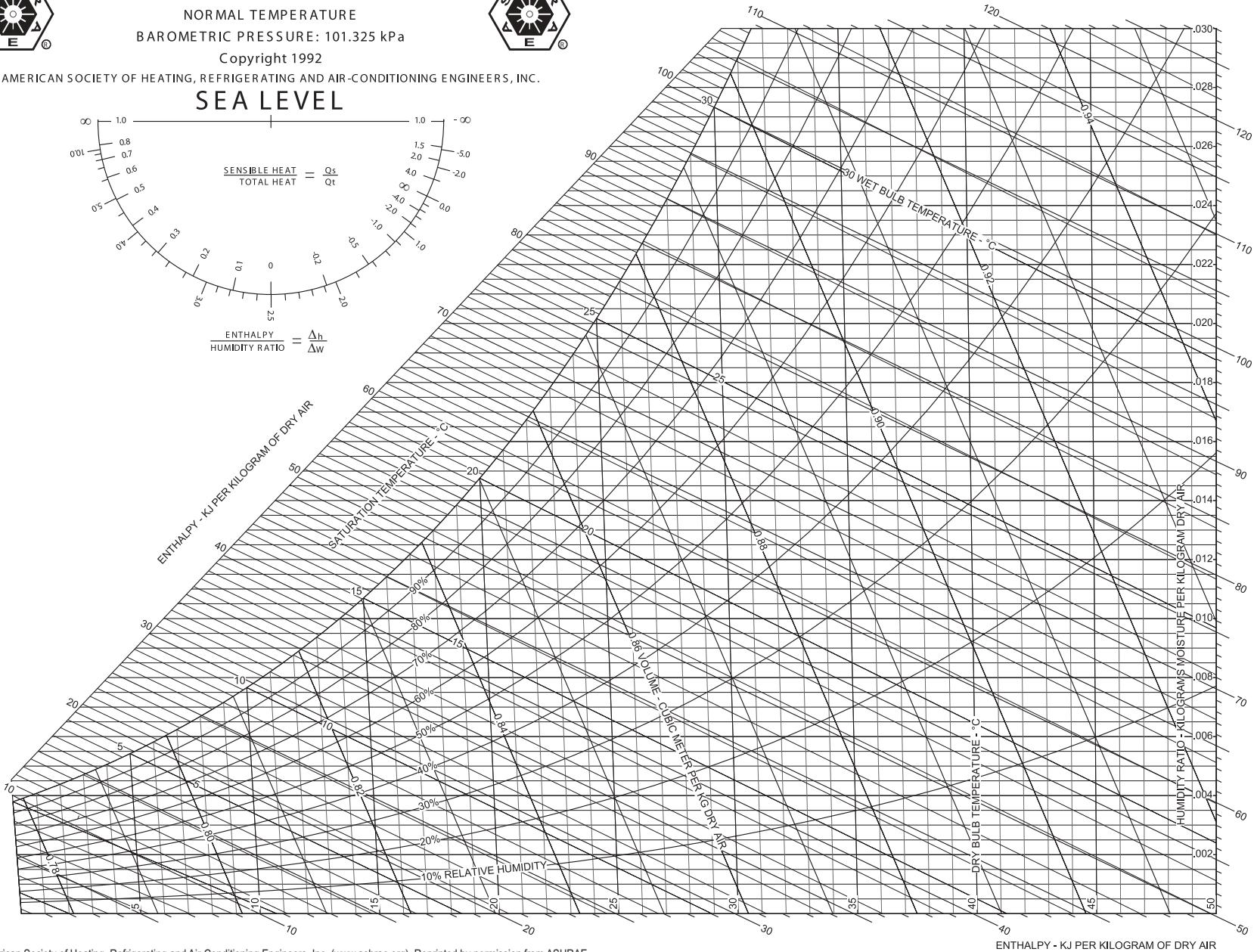
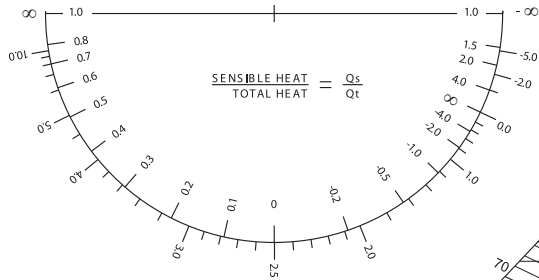

ASHRAE Psychrometric Chart No. 1 (metric units)

©American Society of Heating, Refrigerating and Air-Conditioning Engineers, Inc. (www.ashrae.org). Reprinted by permission from ASHRAE. This chart may not be copied or distributed in either paper or digital form without ASHRAE's permission.

ENTHALPY - KJ PER KILOGRAM OF DRY AIR



ASHRAE PSYCHROMETRIC CHART NO.1

NORMAL TEMPERATURE

BAROMETRIC PRESSURE: 29.921 INCHES OF MERCURY

Copyright 1992

AMERICAN SOCIETY OF HEATING, REFRIGERATING AND AIR-CONDITIONING ENGINEERS, INC.



SEA LEVEL

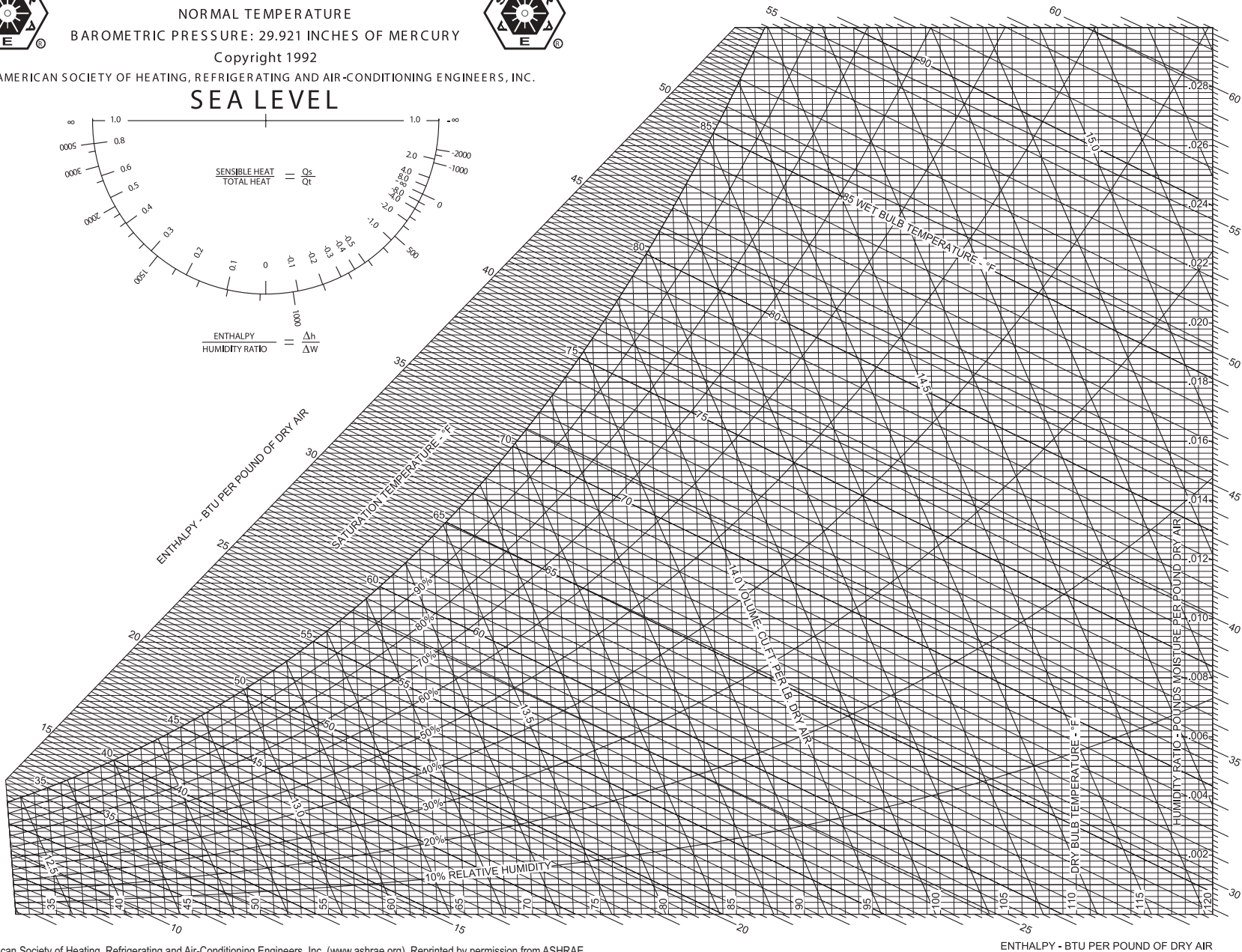
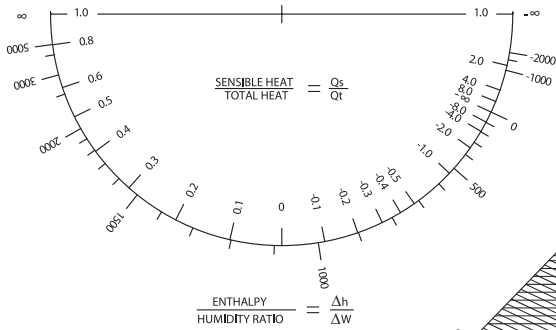

ASHRAE Psychrometric Chart No. 1
(English units)

Fluid Mechanics

Definitions

Density, Specific Volume, Specific Weight, and Specific Gravity

The definitions of density, specific weight, and specific gravity follow:

$$\rho = \lim_{\Delta V \rightarrow 0} \Delta m / \Delta V$$

$$\gamma = \lim_{\Delta V \rightarrow 0} \Delta W / \Delta V$$

$$\gamma = \lim_{\Delta V \rightarrow 0} g \cdot \Delta m / \Delta V = \rho g$$

also

$$SG = \gamma / \gamma_w = \rho / \rho_w$$

where

ρ = density (also called mass density)

Δm = mass of infinitesimal volume

ΔV = volume of infinitesimal object considered

γ = specific weight

$$= \rho g$$

ΔW = weight of an infinitesimal volume

SG = specific gravity

ρ_w = density of water at standard conditions

$$= 1,000 \text{ kg/m}^3 \text{ (62.4 lbm/ft}^3\text{)}$$

γ_w = specific weight of water at standard conditions

$$= 9,810 \text{ N/m}^3 \text{ (62.4 lbf/ft}^3\text{)}$$

$$= 9,810 \text{ kg/(m}^2 \cdot \text{s}^2\text{)}$$

Stress, Pressure, and Viscosity

Stress is defined as

$$\tau(1) = \lim_{\Delta A \rightarrow 0} \Delta F / \Delta A$$

where

$\tau(1)$ = surface stress vector at Point 1

ΔF = force acting on infinitesimal area ΔA

ΔA = infinitesimal area at Point 1

$$\tau_n = -P$$

$$\tau_t = \mu(dv/dy) \text{ (one-dimensional; i.e., } y\text{)}$$

where

τ_n and τ_t = normal and tangential stress components at Point 1, respectively

P = pressure at Point 1

μ = absolute dynamic viscosity of the fluid

$$\text{N}\cdot\text{s/m}^2 \text{ [lbm/(ft}\cdot\text{sec)]}$$

dv = differential velocity

dy = differential distance, normal to boundary

v = velocity at boundary condition

y = normal distance, measured from boundary

ν = kinematic viscosity (m^2/s or ft^2/sec)

where $\nu = \frac{\mu}{\rho}$

For a thin Newtonian fluid film and a linear velocity profile,

$$v(y) = \nu y/\delta; \quad dv/dy = \nu/\delta$$

where

ν = velocity of plate on film

δ = thickness of fluid film

For a power law (non-Newtonian) fluid

$$\tau_t = K (dv/dy)^n$$

where

K = consistency index

n = power law index

$n < 1$ \equiv pseudo plastic

$n > 1$ \equiv dilatant

Surface Tension and Capillarity

Surface tension σ is the force per unit contact length

$$\sigma = F/L$$

where

σ = surface tension, force/length

F = surface force at the interface

L = length of interface

The capillary rise h is approximated by

$$h = (4\sigma \cos \beta)/(\gamma d)$$

where

h = height of the liquid in the vertical tube

σ = surface tension

β = angle made by the liquid with the wetted tube wall

γ = specific weight of the liquid

d = diameter of the capillary tube

Characteristics of a Static Liquid

The Pressure Field in a Static Liquid

The difference in pressure between two different points is

$$P_2 - P_1 = -\gamma (z_2 - z_1) = -\gamma h = -\rho gh$$

Absolute pressure = atmospheric pressure + gauge pressure reading

Absolute pressure = atmospheric pressure – vacuum gauge pressure reading

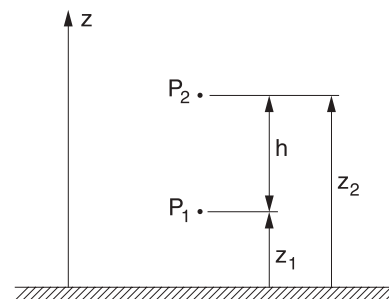

Bober, W., and R.A. Kenyon, *Fluid Mechanics*, Wiley, 1980. Diagrams reprinted by permission of William Bober and Richard A. Kenyon.

Manometers

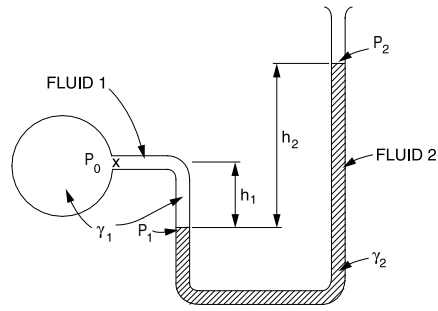

Bober, W., and R.A. Kenyon, *Fluid Mechanics*, Wiley, 1980. Diagrams reprinted by permission of William Bober and Richard A. Kenyon.

For a simple manometer,

$$P_0 = P_2 + \gamma_2 h_2 - \gamma_1 h_1 = P_2 + g(\rho_2 h_2 - \rho_1 h_1)$$

If $h_1 = h_2 = h$

$$P_0 = P_2 + (\gamma_2 - \gamma_1)h = P_2 + (\rho_2 - \rho_1)gh$$

Note that the difference between the two densities is used.

P = pressure

γ = specific weight of fluid

h = height

g = acceleration of gravity

ρ = fluid density

Another device that works on the same principle as the manometer is the simple barometer.

$$P_{\text{atm}} = P_A = P_v + \gamma h = P_B + \gamma h = P_B + \rho gh$$

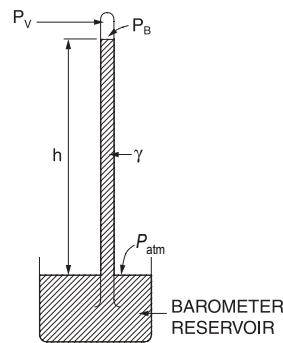

P_v = vapor pressure of the barometer fluid

Bober, W., and R.A. Kenyon, *Fluid Mechanics*, Wiley, 1980. Diagrams reprinted by permission of William Bober and Richard A. Kenyon.

Forces on Submerged Surfaces and the Center of Pressure

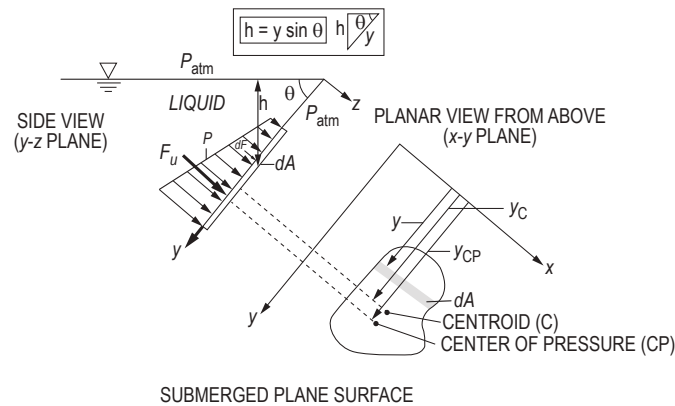

Elger, Donald F., et al, *Engineering Fluid Mechanics*, 10th ed., 2012. Reproduced with permission of John Wiley & Sons, Inc.

The pressure on a point at a vertical distance h below the surface is:

$$P = P_{\text{atm}} + \rho gh, \text{ for } h \geq 0$$

where

P = pressure

P_{atm} = atmospheric pressure

P_C = pressure at the centroid of area

P_{CP} = pressure at center of pressure

y_C = slant distance from liquid surface to the centroid of area

$y_C = h_C / \sin \theta$

h_C = vertical distance from liquid surface to centroid of area

y_{CP} = slant distance from liquid surface to center of pressure

h_{CP} = vertical distance from liquid surface to center of pressure

θ = angle between liquid surface and edge of submerged surface

I_{x_C} = moment of inertia about the centroidal x -axis

If atmospheric pressure acts above the liquid surface and on the non-wetted side of the submerged surface:

$$y_{\text{CP}} = y_C + I_{x_C} / y_C A$$

$$y_{\text{CP}} = y_C + \rho g \sin \theta I_{x_C} / P_C A$$

$$\text{Wetted side: } F_R = (P_{\text{atm}} + \rho g y_C \sin \theta) A$$

$$P_{\text{atm}} \text{ acting both sides: } F_{R_{\text{net}}} = (\rho g y_C \sin \theta) A$$

Archimedes Principle and Buoyancy

1. The buoyant force exerted on a submerged or floating body is equal to the weight of the fluid displaced by the body.
2. A floating body displaces a weight of fluid equal to its own weight; i.e., a floating body is in equilibrium.

The *center of buoyancy* is located at the centroid of the displaced fluid volume.

In the case of a body lying at the *interface of two immiscible fluids*, the buoyant force equals the sum of the weights of the fluids displaced by the body.

Principles of One-Dimensional Fluid Flow

The Continuity Equation

So long as the flow Q is continuous, the *continuity equation*, as applied to one-dimensional flows, states that the flow passing two points (1 and 2) in a stream is equal at each point, $A_1v_1 = A_2v_2$.

$$Q = Av$$

$$\dot{m} = \rho Q = \rho Av$$

where

Q = volumetric flowrate

\dot{m} = mass flowrate

A = cross-sectional area of flow

v = average flow velocity

ρ = the fluid density

For steady, one-dimensional flow, \dot{m} is a constant. If, in addition, the density is constant, then Q is constant.

Energy Equation

The energy equation for steady incompressible flow with no shaft device is

$$\frac{P_1}{\gamma} + z_1 + \frac{v_1^2}{2g} = \frac{P_2}{\gamma} + z_2 + \frac{v_2^2}{2g} + h_f \quad \text{or}$$

$$\frac{P_1}{\rho g} + z_1 + \frac{v_1^2}{2g} = \frac{P_2}{\rho g} + z_2 + \frac{v_2^2}{2g} + h_f$$

where h_f = the head loss, considered a friction effect, and all remaining terms are defined above.

If the cross-sectional area and the elevation of the pipe are the same at both sections (1 and 2), then $z_1 = z_2$ and $v_1 = v_2$.

The pressure drop $P_1 - P_2$ is given by the following:

$$P_1 - P_2 = \gamma h_f = \rho g h_f$$

Bernoulli Equation

The field equation is derived when the energy equation is applied to one-dimensional flows. Assuming no friction losses and that no pump or turbine exists between sections 1 and 2 in the system,

$$\frac{P_2}{\gamma} + \frac{v_2^2}{2g} + z_2 = \frac{P_1}{\gamma} + \frac{v_1^2}{2g} + z_1 \quad \text{or}$$

$$\frac{P_2}{\rho} + \frac{v_2^2}{2} + z_2 g = \frac{P_1}{\rho} + \frac{v_1^2}{2} + z_1 g$$

where

P_1, P_2 = pressure at sections 1 and 2

v_1, v_2 = average velocity of the fluid at the sections

z_1, z_2 = vertical distance from a datum to the sections (the potential energy)

γ = specific weight of the fluid (ρg)

g = acceleration of gravity

ρ = fluid density

Euler's Equation

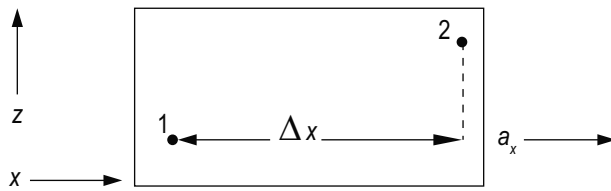

For unsteady flow due to local acceleration (i.e., temporal acceleration) in the x -direction, the change in pressure between two points in a fluid can be determined by Euler's equation:

$$(P_2 + \gamma \cdot z_2) - (P_1 + \gamma \cdot z_1) = -\Delta x \cdot \rho \cdot a_x$$

where

P_1, P_2 = pressure at Locations 1 and 2

γ = specific weight of the fluid (ρg)

z_1, z_2 = elevation at Locations 1 and 2

ρ = fluid density

a_x = local (temporal) acceleration of fluid in the x -direction

Δx = distance between Locations 1 and 2 in the x -direction

Crowe, Clayton T., *Engineering Fluid Mechanics*, 2nd ed., New York: John Wiley and Sons, 1980, p. 144.

Hydraulic Gradient (Grade Line)

Hydraulic grade line is the line connecting the sum of pressure and elevation heads at different points in conveyance systems. If a row of piezometers were placed at intervals along the pipe, the grade line would join the water levels in the piezometer water columns.

Energy Line (Bernoulli Equation)

The Bernoulli equation states that the sum of the pressure, velocity, and elevation heads is constant. The energy line is this sum or the "total head line" above a horizontal datum. The difference between the hydraulic grade line and the energy line is the $v^2/2g$ term.

Fluid flow characterization

Reynolds Number

$$Re = \frac{vD\rho}{\mu} = \frac{vD}{\nu}$$

$$Re' = \frac{v^{(2-n)} D^n \rho}{K \left(\frac{3n+1}{4n} \right)^n 8^{(n-1)}}$$

where

v = fluid velocity

ρ = mass density

D = diameter of the pipe, dimension of the fluid streamline, or characteristic length

μ = dynamic viscosity

ν = kinematic viscosity

Re = Reynolds number (Newtonian fluid)

Re' = Reynolds number (Power law fluid)

K and n are defined in the Stress, Pressure, and Viscosity section.

The critical Reynolds number $(Re)_c$ is defined to be the minimum Reynolds number at which a flow will turn turbulent.

Flow through a pipe is generally characterized as laminar for $Re < 2,100$ and fully turbulent for $Re > 10,000$, and transitional flow for $2,100 < Re < 10,000$.

The velocity distribution for *laminar flow* in circular tubes or between planes is

$$v(r) = v_{\max} \left[1 - \left(\frac{r}{R} \right)^2 \right]$$

where

r = distance (m) from the centerline

R = radius (m) of the tube or half the distance between the parallel planes

v = local velocity (m/s) at r

v_{\max} = velocity (m/s) at the centerline of the duct

$v_{\max} = 1.18 \bar{v}$, for fully turbulent flow

$v_{\max} = 2\bar{v}$, for circular tubes in laminar flow and

$v_{\max} = 1.5\bar{v}$, for parallel planes in laminar flow, where

\bar{v} = average velocity (m/s) in the duct

The shear stress distribution is

$$\frac{\tau}{\tau_w} = \frac{r}{R}$$

where τ and τ_w are the shear stresses at radii r and R , respectively.

Consequences of Fluid Flow

Head Loss Due to Flow

The *Darcy-Weisbach equation* is

$$h_f = f \frac{L}{D} \frac{v^2}{2g}$$

where

f = $f(\text{Re}, \varepsilon/D)$, the Moody, Darcy, or Stanton friction factor

D = diameter of the pipe

L = length over which the pressure drop occurs

ε = roughness factor for the pipe, and other symbols are defined as before

An alternative formulation employed by chemical engineers is

$$h_f = (4f_{\text{Fanning}}) \frac{Lv^2}{D2g} = \frac{2f_{\text{Fanning}} Lv^2}{Dg}$$

$$\text{Fanning friction factor, } f_{\text{Fanning}} = \frac{f}{4}$$

A chart that gives f versus Re for various values of ε/D , known as a *Moody, Darcy, or Stanton diagram*, is available in this section.

Minor Losses in Pipe Fittings, Contractions, and Expansions

Head losses also occur as the fluid flows through pipe fittings (i.e., elbows, valves, couplings, etc.) and sudden pipe contractions and expansions.

$$\frac{P_1}{\gamma} + z_1 + \frac{v_1^2}{2g} = \frac{P_2}{\gamma} + z_2 + \frac{v_2^2}{2g} + h_f + h_{f, \text{fitting}}$$

$$\frac{P_1}{\rho g} + z_1 + \frac{v_1^2}{2g} = \frac{P_2}{\rho g} + z_2 + \frac{v_2^2}{2g} + h_f + h_{f, \text{fitting}}$$

where

$$h_{f, \text{fitting}} = C \frac{v^2}{2g}$$

$$\frac{v^2}{2g} = 1 \text{ velocity head}$$

Specific fittings have characteristic values of C , which will be provided in the problem statement. A generally accepted *nominal value* for head loss in *well-streamlined gradual contractions* is

$$h_{f, \text{fitting}} = 0.04 v^2 / 2g$$

The *head loss* at either an *entrance* or *exit* of a pipe from or to a reservoir is also given by the $h_{f, \text{fitting}}$ equation. Values for C for various cases are shown as follows.

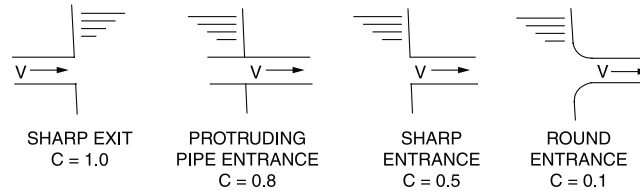

Bober, W., and R.A. Kenyon, *Fluid Mechanics*, Wiley, 1980. Diagrams reprinted by permission of William Bober and Richard A. Kenyon.

Pressure Drop for Laminar Flow

The equation for Q in terms of the pressure drop ΔP_f is the Hagen-Poiseuille equation. This relation is valid only for flow in the laminar region.

$$Q = \frac{\pi R^4 \Delta P_f}{8\mu L} = \frac{\pi D^4 \Delta P_f}{128\mu L}$$

Flow in Noncircular Conduits

Analysis of flow in conduits having a noncircular cross section uses the *hydraulic radius* R_H , or the *hydraulic diameter* D_H , as follows:

$$R_H = \frac{\text{cross-sectional area}}{\text{wetted perimeter}} = \frac{D_H}{4}$$

Drag Force

The *drag force* F_D on objects immersed in a large body of flowing fluid or objects moving through a stagnant fluid is

$$F_D = \frac{C_D \rho v^2 A}{2}$$

where

C_D = drag coefficient

v = velocity (m/s) of the flowing fluid or moving object

A = projected area (m^2) of blunt objects such as spheres, ellipsoids, disks, and plates, cylinders, ellipses, and air foils with axes perpendicular to the flow

ρ = fluid density

For flat plates placed parallel with the flow:

$$C_D = 1.33/\text{Re}^{0.5} \quad (10^4 < \text{Re} < 5 \times 10^5)$$

$$C_D = 0.031/\text{Re}^{1/7} \quad (10^6 < \text{Re} < 10^9)$$

The characteristic length in the Reynolds Number (Re) is the length of the plate parallel with the flow. For blunt objects, the characteristic length is the largest linear dimension (diameter of cylinder, sphere, disk, etc.) that is perpendicular to the flow.

Characteristics of Selected Flow Configurations

Open-Channel Flow and/or Pipe Flow of Water

Manning's Equation

$$Q = \frac{K}{n} A R_H^{2/3} S^{1/2}$$

$$V = \frac{K}{n} R_H^{2/3} S^{1/2}$$

where

Q = discharge (ft³/sec or m³/s)

V = velocity (ft/sec or m/s)

K = 1.486 for USCS units, 1.0 for SI units

n = roughness coefficient

A = cross-sectional area of flow (ft² or m²)

R_H = hydraulic radius (ft or m) = $\frac{A}{P}$

P = wetted perimeter (ft or m)

S = slope (ft/ft or m/m)

Hazen-Williams Equation

$$v = k_1 C R_H^{0.63} S^{0.54}$$

$$Q = k_1 C A R_H^{0.63} S^{0.54}$$

where

k_1 = 0.849 for SI units, 1.318 for USCS units

C = roughness coefficient, as tabulated in the Civil Engineering section. Other symbols are defined as before.

Flow Through a Packed Bed

A porous, fixed bed of solid particles can be characterized by

L = length of particle bed (m)

D_p = average particle diameter (m)

Φ_s = sphericity of particles, dimensionless (0–1)

ε = porosity or void fraction of the particle bed, dimensionless (0–1)

The Ergun equation can be used to estimate pressure loss through a packed bed under laminar and turbulent flow conditions.

$$\frac{\Delta P}{L} = \frac{150 v_o \mu (1 - \varepsilon)^2}{\Phi_s^2 D_p^2 \varepsilon^3} + \frac{1.75 \rho v_o^2 (1 - \varepsilon)}{\Phi_s D_p \varepsilon^3}$$

where

ΔP = pressure loss across packed bed (Pa)

v_o = superficial (flow through empty vessel) fluid velocity (m/s)

ρ = fluid density (kg/m³)

μ = fluid viscosity [kg/(m·s)]

Submerged Orifice Operating under Steady-Flow Conditions:

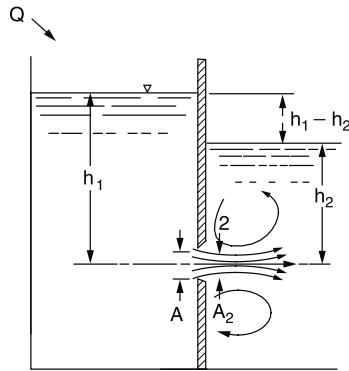

Vennard, J.K., *Elementary Fluid Mechanics*, 6th ed., J.K. Vennard, 1954.

$$Q = A_2 v_2 = C_c C_v A \sqrt{2g(h_1 - h_2)} = CA \sqrt{2g(h_1 - h_2)}$$

in which the product of C_c and C_v is defined as the *coefficient of discharge* of the orifice.

where

v_2 = velocity of fluid exiting orifice

Orifice Discharging Freely into Atmosphere

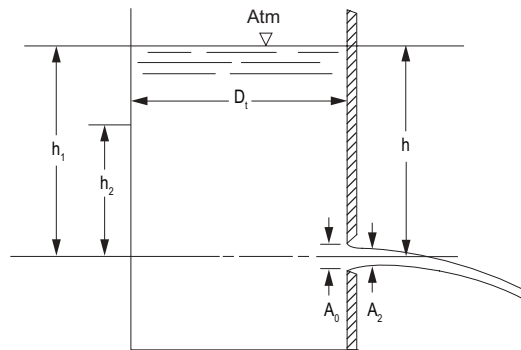

Vennard, J.K., *Elementary Fluid Mechanics*, 6th ed., J.K. Vennard, 1954.

$$Q = CA_0 \sqrt{2gh}$$

in which h is measured from the liquid surface to the centroid of the orifice opening.

Q = volumetric flow

A_0 = cross-sectional area of flow

g = acceleration of gravity

h = height of fluid above orifice

Time required to drain a tank

$$\Delta t = \frac{2(A_t/A_0)}{\sqrt{2g}} (h_1^{1/2} - h_2^{1/2})$$

where

$$A_t = \text{cross-sectional area of tank} = \frac{\pi D_t^2}{4}$$

Multipath Pipeline Problems

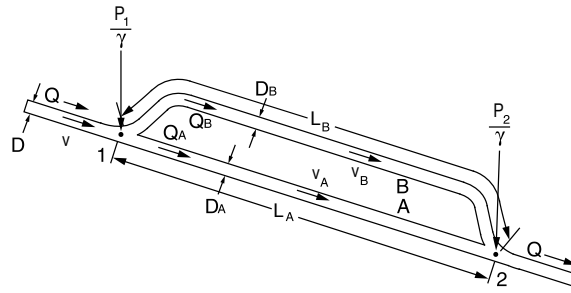

Vennard, J.K., *Elementary Fluid Mechanics*, 6th ed., J.K. Vennard, 1954.

For pipes in parallel, the head loss is the same in each pipe.

$$h_L = f_A \frac{L_A}{D_A} \frac{v_A^2}{2g} = f_B \frac{L_B}{D_B} \frac{v_B^2}{2g}$$

$$(\pi D^2/4)v = (\pi D_A^2/4)v_A + (\pi D_B^2/4)v_B$$

The total flowrate Q is the sum of the flowrates in the parallel pipes.

The Impulse-Momentum Principle

The resultant force in a given direction acting on the fluid equals the rate of change of momentum of the fluid.

$$\Sigma F = \Sigma Q_2 \rho_2 v_2 - \Sigma Q_1 \rho_1 v_1$$

where

ΣF = resultant of all external forces acting on the control volume

$\Sigma Q_1 \rho_1 v_1$ = rate of momentum of the fluid flow entering the control volume in the same direction of the force

$\Sigma Q_2 \rho_2 v_2$ = rate of momentum of the fluid flow leaving the control volume in the same direction of the force

Pipe Bends, Enlargements, and Contractions

The force exerted by a flowing fluid on a bend, enlargement, or contraction in a pipeline may be computed using the impulse-momentum principle.

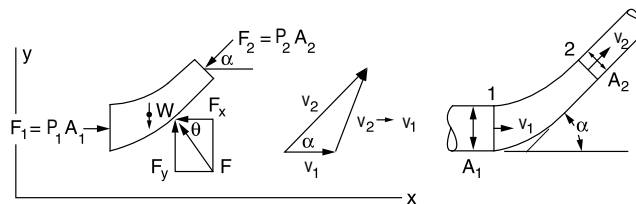

Vennard, J.K., *Elementary Fluid Mechanics*, 6th ed., J.K. Vennard, 1954.

$$P_1 A_1 - P_2 A_2 \cos \alpha - F_x = Q \rho (v_2 \cos \alpha - v_1)$$

$$F_y - W - P_2 A_2 \sin \alpha = Q \rho (v_2 \sin \alpha - 0)$$

where

F = force exerted by the bend on the fluid (the force exerted by the fluid on the bend is equal in magnitude and opposite in sign), F_x and F_y are the x-component and y-component of the force $F = \sqrt{F_x^2 + F_y^2}$ and

$$\theta = \tan^{-1} \left(\frac{F_y}{F_x} \right)$$

where

- P = internal pressure in the pipe line
- A = cross-sectional area of the pipe line
- W = weight of the fluid
- v = velocity of the fluid flow
- α = angle the pipe bend makes with the horizontal
- ρ = density of the fluid
- Q = fluid volumetric flowrate

Jet Propulsion

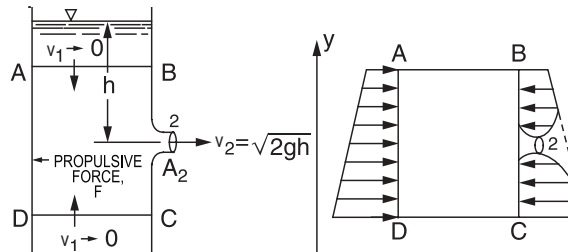

Vennard, J.K., *Elementary Fluid Mechanics*, 6th ed., J.K. Vennard, 1954.

$$F = Q\rho(v_2 - 0)$$

$$F = 2\gamma h A_2$$

where

- F = propulsive force
- γ = specific weight of the fluid
- h = height of the fluid above the outlet
- A_2 = area of the nozzle tip
- $Q = A_2 \sqrt{2gh}$
- $v_2 = \sqrt{2gh}$

Deflectors and Blades

Fixed Blade

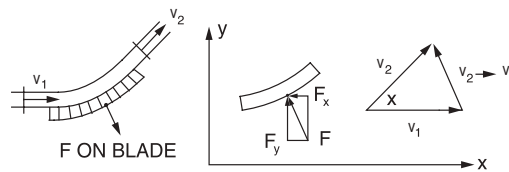

Vennard, J.K., *Elementary Fluid Mechanics*, 6th ed., J.K. Vennard, 1954.

$$-F_x = Q\rho(v_2 \cos \alpha - v_1)$$

$$F_y = Q\rho(v_2 \sin \alpha - 0)$$

Moving Blade

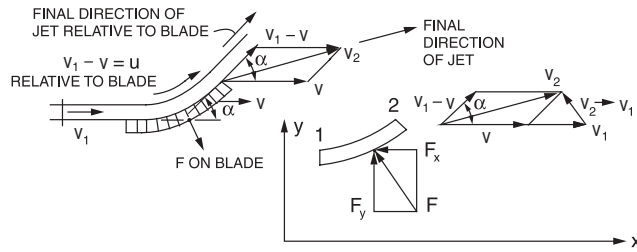

$$-F_x = Q\rho(v_{2x} - v_{1x})$$

$$= -Q\rho(v_1 - v)(1 - \cos \alpha)$$

$$F_y = Q\rho(v_{2y} - v_{1y})$$

$$= +Q\rho(v_1 - v) \sin \alpha$$

where v = velocity of the blade

Vennard, J.K., *Elementary Fluid Mechanics*, 6th ed., J.K. Vennard, 1954.

Impulse Turbine

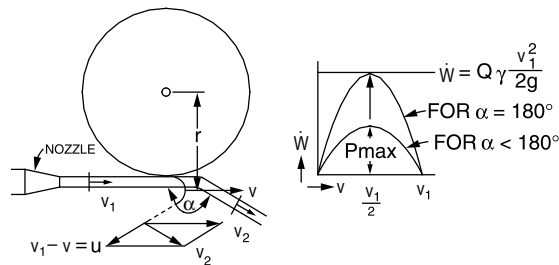

Vennard, J.K., *Elementary Fluid Mechanics*, 6th ed., J.K. Vennard, 1954.

$$\dot{W} = Q\rho(v_1 - v)(1 - \cos \alpha)v$$

\dot{W} = power of the turbine.

where $\dot{W}_{max} = Q\rho(v_1^2/4)(1 - \cos \alpha)$

When $\alpha = 180^\circ$,

$$\dot{W}_{max} = (Q\rho v_1^2)/2 = (Q\gamma v_1^2)/2g$$

Compressible Flow

Mach Number

The local *speed of sound* in an ideal gas is given by:

$$c = \sqrt{kRT}$$

where

c \equiv local speed of sound

k \equiv ratio of specific heats = $\frac{c_p}{c_v}$

R \equiv specific gas constant = $\bar{R}/(\text{molecular weight})$

T \equiv absolute temperature

Example: speed of sound in dry air at 1 atm 20°C is 343.2 m/s.

This shows that the acoustic velocity in an ideal gas depends only on its temperature. The *Mach number* (Ma) is the ratio of the fluid velocity to the speed of sound.

$$Ma \equiv \frac{V}{c}$$

$V \equiv$ mean fluid velocity

Isentropic Flow Relationships

In an ideal gas for an isentropic process, the following relationships exist between static properties at any two points in the flow.

$$\frac{P_2}{P_1} = \left(\frac{T_2}{T_1}\right)^{\frac{k}{k-1}} = \left(\frac{\rho_2}{\rho_1}\right)^k$$

The stagnation temperature, T_0 , at a point in the flow is related to the static temperature as follows:

$$T_0 = T + \frac{V^2}{2 \cdot c_p}$$

Energy relation between two points:

$$h_1 + \frac{V_1^2}{2} = h_2 + \frac{V_2^2}{2}$$

Vennard, J.K., *Elementary Fluid Mechanics*, 6th ed., J.K. Vennard, 1954.

The relationship between the static and stagnation properties (T_0 , P_0 , and ρ_0) at any point in the flow can be expressed as a function of the Mach number as follows:

$$\frac{T_0}{T} = 1 + \frac{k-1}{2} \cdot Ma^2$$

$$\frac{P_0}{P} = \left(\frac{T_0}{T}\right)^{\frac{k}{k-1}} = \left(1 + \frac{k-1}{2} \cdot Ma^2\right)^{\frac{k}{k-1}}$$

$$\frac{\rho_0}{\rho} = \left(\frac{T_0}{T}\right)^{\frac{1}{k-1}} = \left(1 + \frac{k-1}{2} \cdot Ma^2\right)^{\frac{1}{k-1}}$$

Compressible flows are often accelerated or decelerated through a nozzle or diffuser. For subsonic flows, the velocity decreases as the flow cross-sectional area increases and vice versa. For supersonic flows, the velocity increases as the flow cross-sectional area increases and decreases as the flow cross-sectional area decreases. The point at which the Mach number is sonic is called the throat and its area is represented by the variable, A^* . The following area ratio holds for any Mach number.

$$\frac{A}{A^*} = \frac{1}{Ma} \left[\frac{1 + \frac{1}{2}(k-1)Ma^2}{\frac{1}{2}(k+1)} \right]^{\frac{(k+1)}{2(k-1)}}$$

where

$$A \equiv \text{area [length}^2\text{]}$$

$$A^* \equiv \text{area at the sonic point (Ma = 1.0)}$$

Normal Shock Relationships

A normal shock wave is a physical mechanism that slows a flow from supersonic to subsonic. It occurs over an infinitesimal distance. The flow upstream of a normal shock wave is always supersonic and the flow downstream is always subsonic as depicted in the figure.

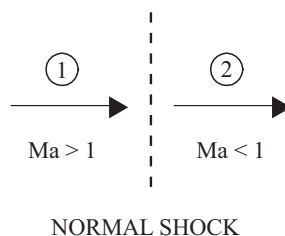

The following equations relate downstream flow conditions to upstream flow conditions for a normal shock wave.

$$Ma_2 = \sqrt{\frac{(k-1)Ma_1^2 + 2}{2kMa_1^2 - (k-1)}}$$

$$\frac{T_2}{T_1} = \left[2 + (k-1)Ma_1^2\right] \frac{2kMa_1^2 - (k-1)}{(k+1)^2Ma_1^2}$$

$$\frac{P_2}{P_1} = \frac{1}{k+1} [2kMa_1^2 - (k-1)]$$

$$\frac{\rho_2}{\rho_1} = \frac{V_1}{V_2} = \frac{(k+1)Ma_1^2}{(k-1)Ma_1^2 + 2}$$

$$T_{01} = T_{02}$$

Fluid Flow Machinery

Centrifugal Pump Characteristics

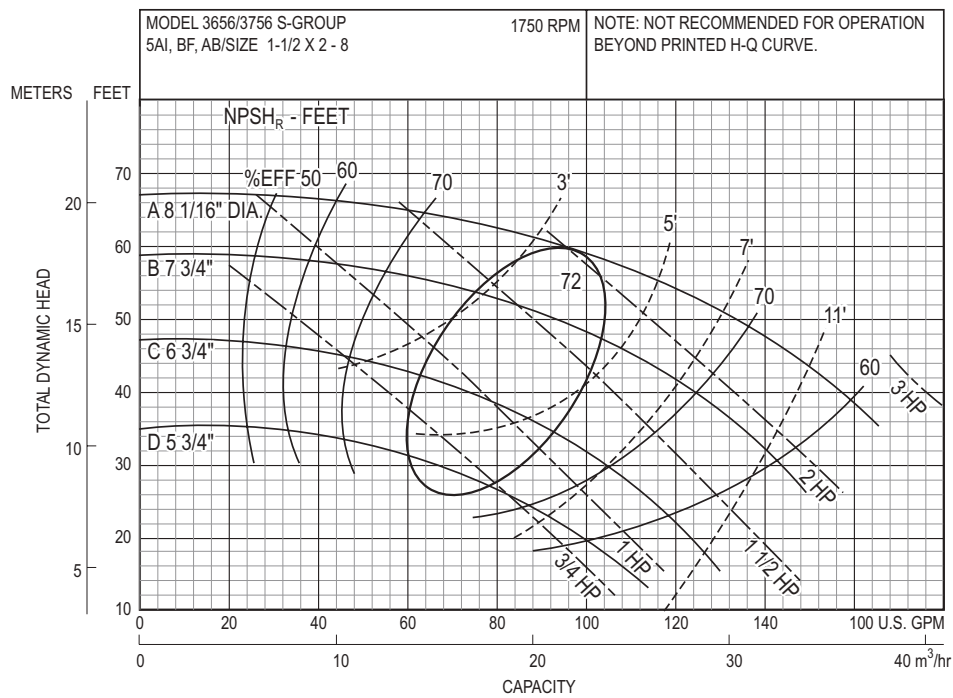
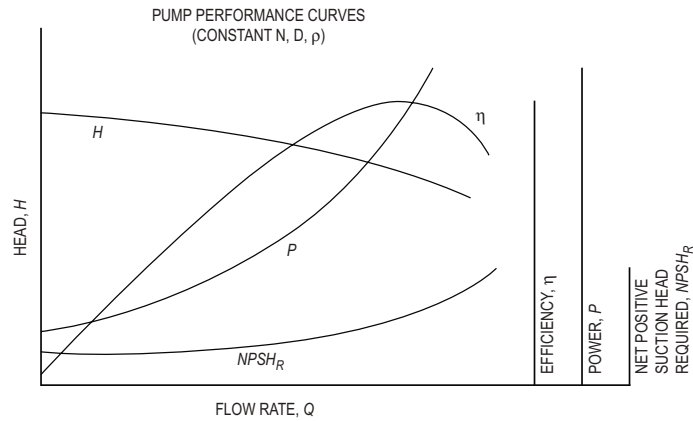

CENTRIFUGAL PUMP CURVE FOR A GOULD MODEL 3656/3756 PUMP

Net Positive Suction Head Available ($NPSH_A$)

$$NPSH_A = H_{pa} + H_s - \sum h_L - H_{vp} = \frac{P_{inlet}}{\rho g} + \frac{v_{inlet}^2}{2g} - \frac{P_{vapor}}{\rho g}$$

where

- H_{pa} = atmospheric pressure head on the surface of the liquid in the sump (ft or m)
- H_s = static suction head of liquid. This is the height of the surface of the liquid above the centerline of the pump impeller (ft or m).
- $\sum h_L$ = total friction losses in the suction line (ft or m)
- H_{vp} = vapor pressure head of the liquid at the operating temperature (ft or m)
- v = fluid velocity at pump inlet
- P_{vapor} = fluid vapor pressure at pump inlet
- ρ = fluid density
- g = acceleration due to gravity

Fluid power $\dot{W}_{fluid} = \rho g H Q$

Pump (brake) power $\dot{W} = \frac{\rho g H Q}{\eta_{pump}}$

Purchased power $\dot{W}_{purchased} = \frac{\dot{W}}{\eta_{motor}}$

where

- η_{pump} = pump efficiency (0 to 1)
- η_{motor} = motor efficiency (0 to 1)
- H = head increase provided by pump

Pump Power Equation

$$\dot{W} = Q \gamma h / \eta_t = Q \rho g h / \eta_t$$

where

- Q = volumetric flow (m^3/s or cfs)
- h = head (m or ft) the fluid has to be lifted
- η_t = total efficiency ($\eta_{pump} \times \eta_{motor}$)
- \dot{W} = power ($kg \cdot m^2 / sec^3$ or ft-lbf/sec)

Fan Characteristics

Typical Backward Curved Fans

$$\dot{W} = \frac{\Delta P Q}{\eta_f}$$

where

- \dot{W} = fan power
- ΔP = pressure rise
- η_f = fan efficiency

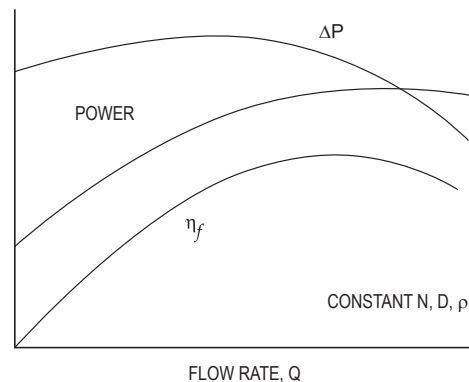

Compressors

Compressors consume power to add energy to the working fluid. This energy addition results in an increase in fluid pressure (head).

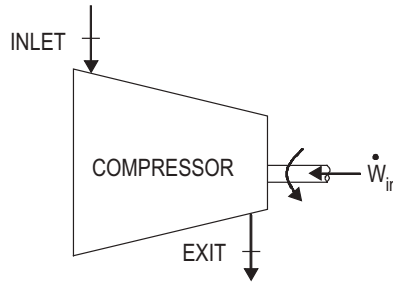

For an adiabatic compressor with $\Delta PE = 0$ and negligible ΔKE :

$$\dot{W}_{\text{comp}} = -\dot{m}(h_e - h_i)$$

For an ideal gas with constant specific heats:

$$\dot{W}_{\text{comp}} = -\dot{m}c_p(T_e - T_i)$$

Per unit mass:

$$w_{\text{comp}} = -c_p(T_e - T_i)$$

Compressor Isentropic Efficiency

$$\eta_C = \frac{w_s}{w_a} = \frac{T_{es} - T_i}{T_e - T_i}$$

where

$w_a \equiv$ actual compressor work per unit mass

$w_s \equiv$ isentropic compressor work per unit mass

$T_{es} \equiv$ isentropic exit temperature

For a compressor where ΔKE is included:

$$\begin{aligned} \dot{W}_{\text{comp}} &= -\dot{m} \left(h_e - h_i + \frac{V_e^2 - V_i^2}{2} \right) \\ &= -\dot{m} \left(c_p(T_e - T_i) + \frac{V_e^2 - V_i^2}{2} \right) \end{aligned}$$

Adiabatic Compression

$$\dot{W}_{\text{comp}} = \frac{\dot{m} P_i k}{(k - 1) \rho_i \eta_c} \left[\left(\frac{P_e}{P_i} \right)^{1 - 1/k} - 1 \right]$$

where

$\dot{W}_{\text{comp}} =$ fluid or gas power (W)

$P_i =$ inlet or suction pressure (N/m²)

$P_e =$ exit or discharge pressure (N/m²)

$k =$ ratio of specific heats = c_p/c_v

$\rho_i =$ inlet gas density (kg/m³)

$\eta_c =$ isentropic compressor efficiency

Isothermal Compression

$$\dot{W}_{\text{comp}} = \frac{\bar{R}T_i}{M\eta_c} \ln \frac{P_e}{P_i} (\dot{m})$$

where

\dot{W}_{comp} , P_i , P_e , and η_c as defined for adiabatic compression

\bar{R} = universal gas constant

T_i = inlet temperature of gas (K)

M = molecular weight of gas (kg/kmol)

Blowers

$$P_w = \frac{WRT_1}{Cne} \left[\left(\frac{P_2}{P_1} \right)^{0.283} - 1 \right]$$

where

C = 29.7 (constant for SI unit conversion)

= 550 ft-lbf/(sec-hp) (U.S. Customary Units)

P_w = power requirement (hp)

W = weight of flow of air (lb/sec)

R = engineering gas constant for air = 53.3 ft-lbf/(lb air-°R)

T_1 = absolute inlet temperature (°R)

P_1 = absolute inlet pressure (lbf/in²)

P_2 = absolute outlet pressure (lbf/in²)

n = $(k - 1)/k = 0.283$ for air

e = efficiency (usually $0.70 < e < 0.90$)

Metcalf and Eddy, *Wastewater Engineering: Treatment, Disposal, and Reuse*, 3rd ed., McGraw-Hill, 1991.

Turbines

Turbines produce power by extracting energy from a working fluid. The energy loss shows up as a decrease in fluid pressure (head).

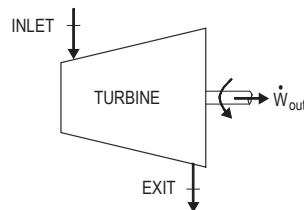

For an adiabatic turbine with $\Delta PE = 0$ and negligible ΔKE :

$$\dot{W}_{\text{turb}} = \dot{m}(h_i - h_e)$$

For an ideal gas with constant specific heats:

$$\dot{W}_{\text{turb}} = \dot{m}c_p(T_i - T_e)$$

Per unit mass:

$$w_{\text{turb}} = c_p(T_i - T_e)$$

Turbine Isentropic Efficiency

$$\eta_T = \frac{w_a}{w_s} = \frac{T_i - T_e}{T_i - T_{es}}$$

For a turbine where ΔKE is included:

$$\dot{W}_{\text{turb}} = \dot{m} \left(h_i - h_e + \frac{V_i^2 - V_e^2}{2} \right) = \dot{m} \left(c_p(T_i - T_e) + \frac{V_i^2 - V_e^2}{2} \right)$$

Performance of Components

Fans, Pumps, and Compressors

Scaling Laws; Affinity Laws

$$\left(\frac{Q}{ND^3}\right)_2 = \left(\frac{Q}{ND^3}\right)_1$$

$$\left(\frac{\dot{m}}{\rho ND^3}\right)_2 = \left(\frac{\dot{m}}{\rho ND^3}\right)_1$$

$$\left(\frac{H}{N^2 D^2}\right)_2 = \left(\frac{H}{N^2 D^2}\right)_1$$

$$\left(\frac{P}{\rho N^2 D^2}\right)_2 = \left(\frac{P}{\rho N^2 D^2}\right)_1$$

$$\left(\frac{\dot{W}}{\rho N^3 D^5}\right)_2 = \left(\frac{\dot{W}}{\rho N^3 D^5}\right)_1$$

where

Q = volumetric flowrate

\dot{m} = mass flowrate

H = head

P = pressure rise

\dot{W} = power

ρ = fluid density

N = rotational speed

D = impeller diameter

Subscripts 1 and 2 refer to different but similar machines or to different operating conditions of the same machine.

Fluid Flow Measurement

The Pitot Tube

From the stagnation pressure equation for an incompressible fluid,

$$v = \sqrt{(2/\rho)(P_0 - P_s)} = \sqrt{2g(P_0 - P_s)/\gamma}$$

where

v = velocity of the fluid

P_0 = stagnation pressure

P_s = static pressure of the fluid at the elevation where the measurement is taken

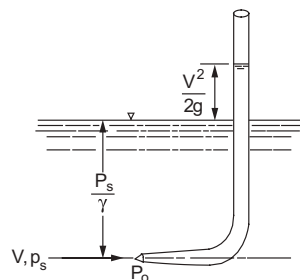

Vennard, J.K., *Elementary Fluid Mechanics*, 6th ed., J.K. Vennard, 1954.

For a *compressible fluid*, use the above incompressible fluid equation if the Mach number ≤ 0.3 .

Venturi Meters

$$Q = \frac{C_v A_2}{\sqrt{1 - (A_2/A_1)^2}} \sqrt{2g \left(\frac{P_1}{\gamma} + z_1 - \frac{P_2}{\gamma} - z_2 \right)}$$

where

- Q = volumetric flowrate
- C_v = coefficient of velocity
- A = cross-sectional area of flow
- P = pressure
- γ = ρg
- z_1 = elevation of venturi entrance
- z_2 = elevation of venturi throat

The above equation is for *incompressible fluids*.

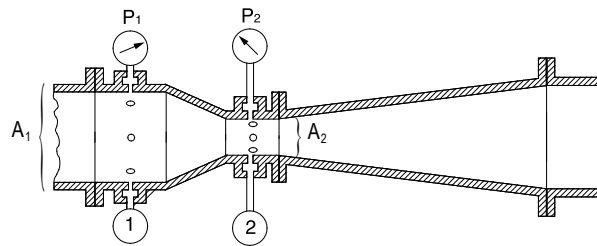

Vennard, J.K., *Elementary Fluid Mechanics*, 6th ed., J.K. Vennard, 1954.

Orifices

The cross-sectional area at the vena contracta A_2 is characterized by a *coefficient of contraction* C_c and given by $C_c A_0$.

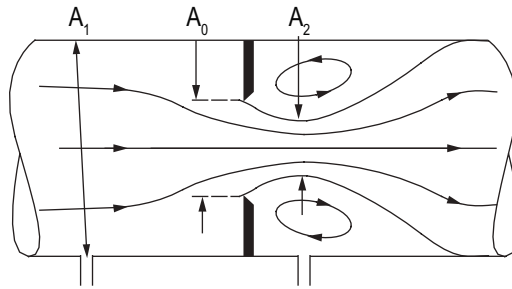





Vennard, J.K., *Elementary Fluid Mechanics*, 6th ed., J.K. Vennard, 1954.

$$Q = C A_0 \sqrt{2g \left(\frac{P_1}{\gamma} + z_1 - \frac{P_2}{\gamma} - z_2 \right)}$$

where C , the *coefficient of the meter (orifice coefficient)*, is given by

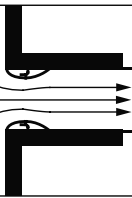
$$C = \frac{C_v C_c}{\sqrt{1 - C_c^2 (A_0/A_1)^2}}$$

ORIFICES AND THEIR NOMINAL COEFFICIENTS				
	SHARP EDGED	ROUNDED	SHORT TUBE	BORDA
				
C	0.61	0.98	0.80	0.51
C _C	0.62	1.00	1.00	0.52
C _V	0.98	0.98	0.80	0.98

Bober, W., and R.A. Kenyon, *Fluid Mechanics*, Wiley, 1980. Diagrams reprinted by permission of William Bober and Richard A. Kenyon.

For incompressible flow through a horizontal orifice meter installation

$$Q = CA_0 \sqrt{\frac{2}{\rho}(P_1 - P_2)}$$

Dimensional Homogeneity

Dimensional Analysis

A dimensionally homogeneous equation has the same dimensions on the left and right sides of the equation. Dimensional analysis involves the development of equations that relate dimensionless groups of variables to describe physical phenomena.

Buckingham Pi Theorem: The *number of independent dimensionless groups* that may be employed to describe a phenomenon known to involve n variables is equal to the number $(n - \bar{r})$, where \bar{r} is the number of basic dimensions (e.g., M, L, T) needed to express the variables dimensionally.

Similitude

In order to use a model to simulate the conditions of the prototype, the model must be *geometrically, kinematically, and dynamically similar* to the prototype system.

To obtain dynamic similarity between two flow pictures, all independent force ratios that can be written must be the same in both the model and the prototype. Thus, dynamic similarity between two flow pictures (when all possible forces are acting) is expressed in the five simultaneous equations below.

$$\begin{aligned} \left[\frac{F_I}{F_P} \right]_p &= \left[\frac{F_I}{F_P} \right]_m = \left[\frac{\rho v^2}{P} \right]_p = \left[\frac{\rho v^2}{P} \right]_m \\ \left[\frac{F_I}{F_V} \right]_p &= \left[\frac{F_I}{F_V} \right]_m = \left[\frac{vl\rho}{\mu} \right]_p = \left[\frac{vl\rho}{\mu} \right]_m = [\text{Re}]_p = [\text{Re}]_m \\ \left[\frac{F_I}{F_G} \right]_p &= \left[\frac{F_I}{F_G} \right]_m = \left[\frac{v^2}{lg} \right]_p = \left[\frac{v^2}{lg} \right]_m = [\text{Fr}]_p = [\text{Fr}]_m \\ \left[\frac{F_I}{F_E} \right]_p &= \left[\frac{F_I}{F_E} \right]_m = \left[\frac{\rho v^2}{E_v} \right]_p = \left[\frac{\rho v^2}{E_v} \right]_m = [\text{Ca}]_p = [\text{Ca}]_m \\ \left[\frac{F_I}{F_T} \right]_p &= \left[\frac{F_I}{F_T} \right]_m = \left[\frac{\rho lv^2}{\sigma} \right]_p = \left[\frac{\rho lv^2}{\sigma} \right]_m = [\text{We}]_p = [\text{We}]_m \end{aligned}$$

where the subscripts p and m stand for *prototype* and *model* respectively, and

- F_I = inertia force
- F_P = pressure force
- F_V = viscous force
- F_G = gravity force
- F_E = elastic force
- F_T = surface tension force
- Re = Reynolds number
- We = Weber number
- Ca = Cauchy number
- Fr = Froude number
- l = characteristic length
- v = velocity
- ρ = density
- σ = surface tension
- E_v = bulk modulus
- μ = dynamic viscosity
- P = pressure
- g = acceleration of gravity

Aerodynamics

Airfoil Theory

The lift force on an airfoil F_L is given by

$$F_L = \frac{C_L \rho v^2 A_p}{2}$$

where

- C_L = lift coefficient
- ρ = fluid density
- v = velocity (m/s) of the undisturbed fluid and
- A_p = projected area of the airfoil as seen from above (plan area). This same area is used in defining the drag coefficient for an airfoil.

The lift coefficient C_L can be approximated by the equation

$$C_L = 2\pi k_1 \sin(\alpha + \beta), \text{ which is valid for small values of } \alpha \text{ and } \beta$$

where

- k_1 = constant of proportionality
- α = angle of attack (angle between chord of airfoil and direction of flow)
- β = negative of angle of attack for zero lift

The drag coefficient C_D may be approximated by

$$C_D = C_{D\infty} + \frac{C_L^2}{\pi AR}$$

where $C_{D\infty}$ = infinite span drag coefficient

The aspect ratio AR is defined

$$AR = \frac{b^2}{A_p} = \frac{A_p}{c^2}$$

where

- b = span length
- A_p = plan area
- c = chord length

The aerodynamic moment M is given by

$$M = \frac{C_M \rho v^2 A_p c}{2}$$

where the moment is taken about the front quarter point of the airfoil.

- C_M = moment coefficient
- ρ = fluid density
- v = velocity

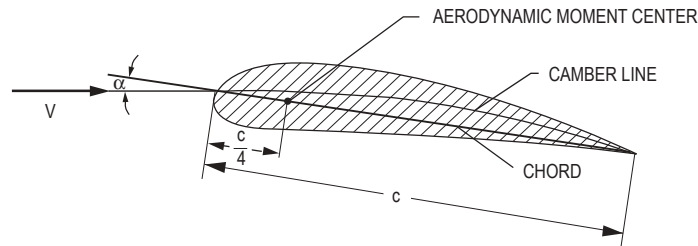

Properties of Water (SI Metric Units)

Temperature (°C)	Specific Weight γ (kN/m ³)	Density ρ (kg/m ³)	Absolute Dynamic Viscosity μ (Pa•s)	Kinematic Viscosity ν (m ² /s)	Vapor Pressure P_v (kPa)
0	9.805	999.8	0.001781	0.000001785	0.61
5	9.807	1000.0	0.001518	0.000001518	0.87
10	9.804	999.7	0.001307	0.000001306	1.23
15	9.798	999.1	0.001139	0.000001139	1.70
20	9.789	998.2	0.001002	0.000001003	2.34
25	9.777	997.0	0.000890	0.000000893	3.17
30	9.764	995.7	0.000798	0.000000800	4.24
40	9.730	992.2	0.000653	0.000000658	7.38
50	9.689	988.0	0.000547	0.000000553	12.33
60	9.642	983.2	0.000466	0.000000474	19.92
70	9.589	977.8	0.000404	0.000000413	31.16
80	9.530	971.8	0.000354	0.000000364	47.34
90	9.466	965.3	0.000315	0.000000326	70.10
100	9.399	958.4	0.000282	0.000000294	101.33

Properties of Water (English Units)

Temperature (°F)	Specific Weight γ (lbf/ft ³)	Mass Density ρ (lbf-sec ² /ft ⁴)	Absolute Dynamic Viscosity μ ($\times 10^{-5}$ lbf-sec/ft ²)	Kinematic Viscosity ν ($\times 10^{-5}$ ft ² /sec)	Vapor Pressure P_v (psi)
32	62.42	1.940	3.746	1.931	0.09
40	62.43	1.940	3.229	1.664	0.12
50	62.41	1.940	2.735	1.410	0.18
60	62.37	1.938	2.359	1.217	0.26
70	62.30	1.936	2.050	1.059	0.36
80	62.22	1.934	1.799	0.930	0.51
90	62.11	1.931	1.595	0.826	0.70
100	62.00	1.927	1.424	0.739	0.95
110	61.86	1.923	1.284	0.667	1.24
120	61.71	1.918	1.168	0.609	1.69
130	61.55	1.913	1.069	0.558	2.22
140	61.38	1.908	0.981	0.514	2.89
150	61.20	1.902	0.905	0.476	3.72
160	61.00	1.896	0.838	0.442	4.74
170	60.80	1.890	0.780	0.413	5.99
180	60.58	1.883	0.726	0.385	7.51
190	60.36	1.876	0.678	0.362	9.34
200	60.12	1.868	0.637	0.341	11.52
212	59.83	1.860	0.593	0.319	14.70

Vennard, John K., and Robert L. Street, *Elementary Fluid Mechanics*, 6th ed., New York: Wiley, 1982, p. 663. Reproduced with permission of John Wiley & Sons, Inc.

Moody, Darcy, or Stanton Friction Factor Diagram

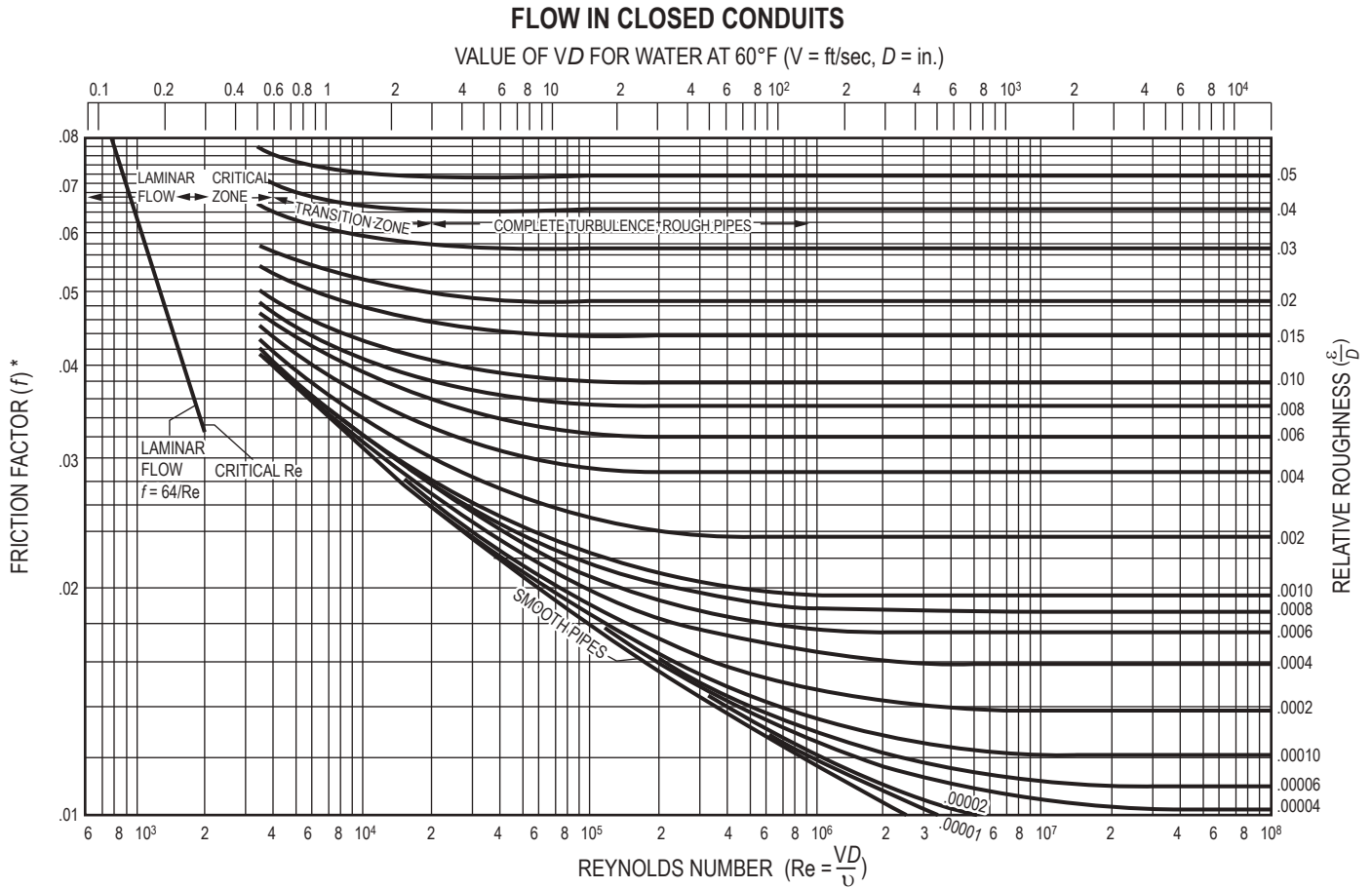

* The Fanning Friction is this factor divided by 4.

	ϵ (ft)	ϵ (mm)
GLASS, DRAWN BRASS, COPPER, LEAD	SMOOTH	SMOOTH
COMMERCIAL STEEL, WROUGHT IRON	0.0001–0.0003	0.03–0.09
ASPHALTED CAST IRON	0.0002–0.0006	0.06–0.18
GALVANIZED IRON	0.0002–0.0008	0.06–0.24
CAST IRON	0.0006–0.003	0.18–0.91
CONCRETE	0.001–0.01	0.30–3.0
RIVETED STEEL	0.003–0.03	0.91–9.1
CORRUGATED METAL PIPE	0.1–0.2	30–61
LARGE TUNNEL, CONCRETE OR STEEL LINED	0.002–0.004	0.61–1.2
BLASTED ROCK TUNNEL	1.0–2.0	300–610

Chow, Ven Te, *Handbook of Applied Hydrology*, McGraw-Hill, 1964.

Drag Coefficient for Spheres, Disks, and Cylinders

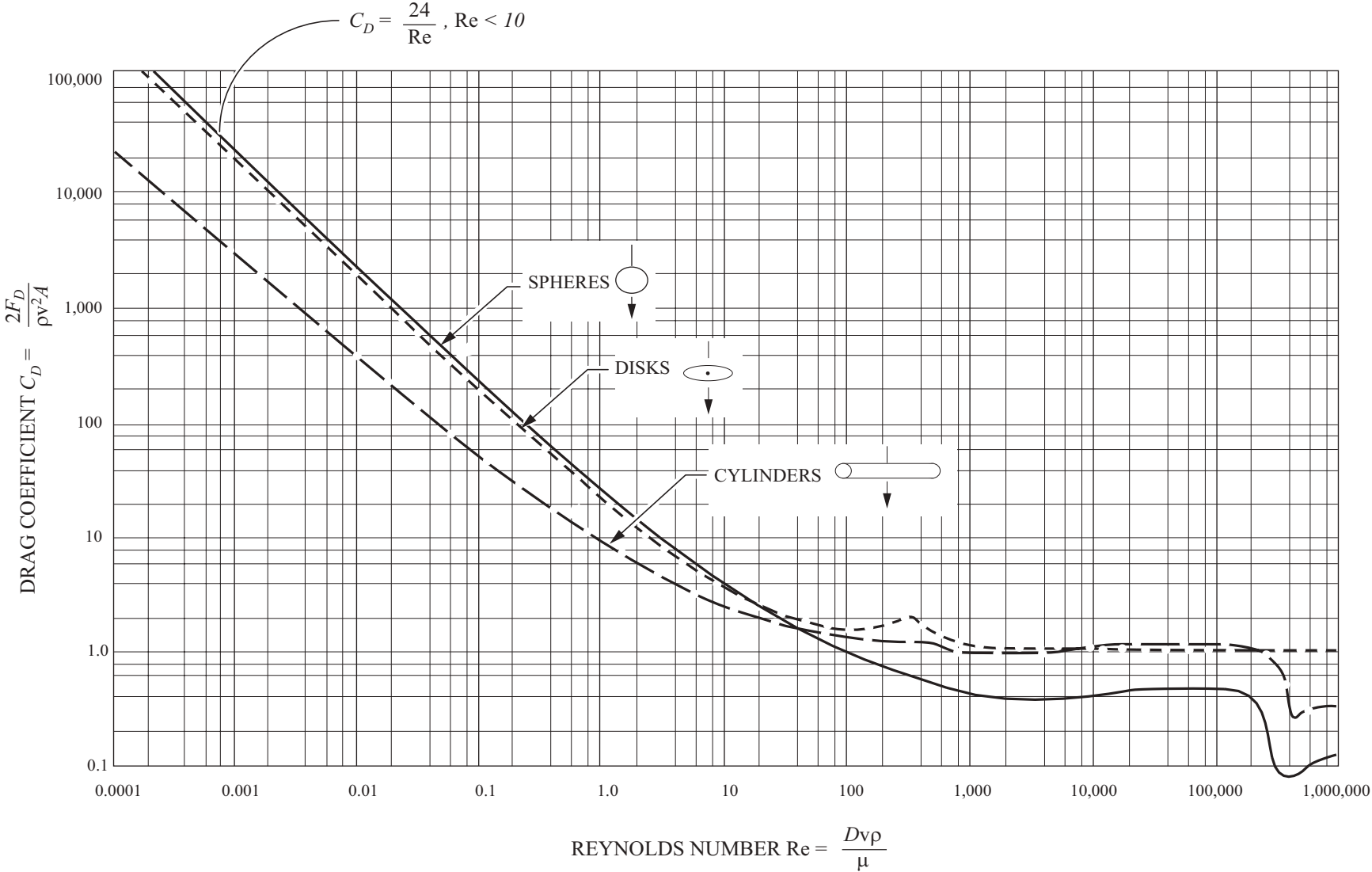

Note: Intermediate divisions are 2, 4, 6, and 8

Terminal Velocities of Spherical Particles of Different Densities

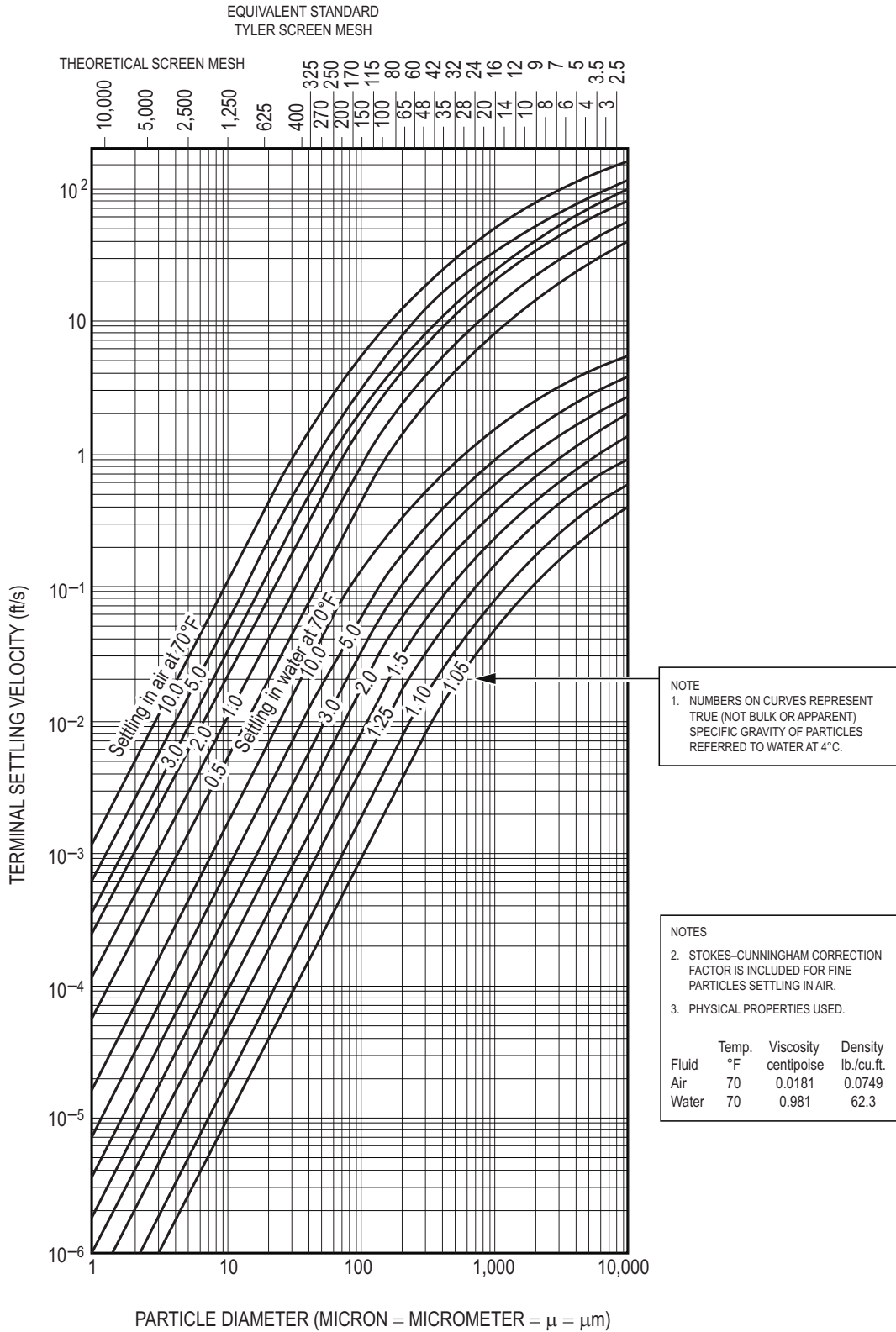

Heat Transfer

There are three modes of heat transfer: conduction, convection, and radiation.

Basic Heat-Transfer Rate Equations

Conduction

Fourier's Law of Conduction

$$\dot{Q} = -kA \frac{dT}{dx}$$

where

$$\dot{Q} = \text{rate of heat transfer (W)}$$

$$k = \text{thermal conductivity [W/(m}\cdot\text{K)]}$$

$$A = \text{surface area perpendicular to direction of heat transfer (m}^2\text{)}$$

Convection

Newton's Law of Cooling

$$\dot{Q} = hA(T_w - T_\infty)$$

where

$$h = \text{convection heat-transfer coefficient of the fluid [W/(m}^2\cdot\text{K)]}$$

$$A = \text{convection surface area (m}^2\text{)}$$

$$T_w = \text{wall surface temperature (K)}$$

$$T_\infty = \text{bulk fluid temperature (K)}$$

Radiation

The radiation emitted by a body is given by

$$\dot{Q} = \varepsilon\sigma AT^4$$

where

$$\varepsilon = \text{emissivity of the body}$$

$$\sigma = \text{Stefan-Boltzmann constant}$$
$$= 5.67 \times 10^{-8} \text{ W/(m}^2\cdot\text{K}^4\text{)}$$

$$A = \text{body surface area (m}^2\text{)}$$

$$T = \text{absolute temperature (K)}$$

Conduction

Conduction Through a Plane Wall

$$\dot{Q} = \frac{-kA(T_2 - T_1)}{L}$$

where

$$A = \text{wall surface area normal to heat flow (m}^2\text{)}$$

$$L = \text{wall thickness (m)}$$

$$T_1 = \text{temperature of one surface of the wall (K)}$$

$$T_2 = \text{temperature of the other surface of the wall (K)}$$

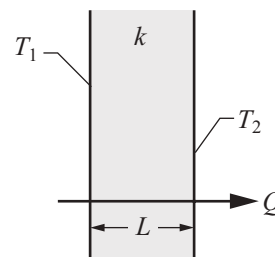

Conduction Through a Cylindrical Wall

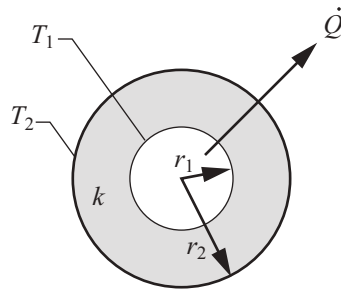

Cylinder (Length = L)

$$\dot{Q} = \frac{2\pi kL(T_1 - T_2)}{\ln\left(\frac{r_2}{r_1}\right)}$$

Critical Insulation Radius

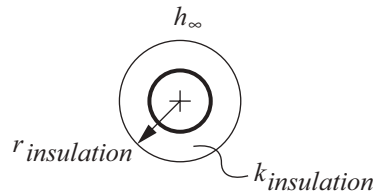

$$r_{cr} = \frac{k_{insulation}}{h_{\infty}}$$

Thermal Resistance (R)

$$\dot{Q} = \frac{\Delta T}{R_{total}}$$

Resistances in series are added:

$$R_{total} = \Sigma R$$

where

Plane Wall Conduction Resistance (K/W):

$$R = \frac{L}{kA}$$

where L = wall thickness

Cylindrical Wall Conduction Resistance (K/W):

$$R = \frac{\ln\left(\frac{r_2}{r_1}\right)}{2\pi kL}$$

where L = cylinder length

Convection Resistance (K/W) :

$$R = \frac{1}{hA}$$

Composite Plane Wall

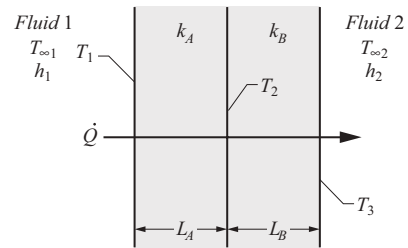
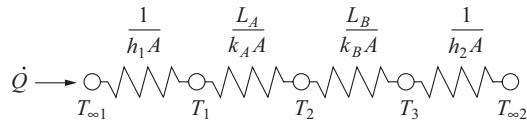

To evaluate surface or intermediate temperatures:

$$\dot{Q} = \frac{T_1 - T_2}{R_A} = \frac{T_2 - T_3}{R_B}$$

Transient Conduction Using the Lumped Capacitance Model

The lumped capacitance model is valid if

$$\text{Biot number, } Bi = \frac{hV}{kA_s} < 0.1$$

where

h = convection heat-transfer coefficient of the fluid [W/(m²•K)]

V = volume of the body (m³)

k = thermal conductivity of the body [W/(m•K)]

A_s = surface area of the body (m²)

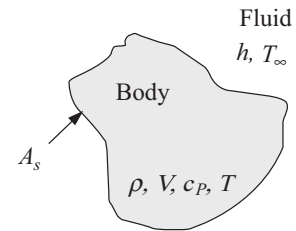

Constant Fluid Temperature

If the temperature may be considered uniform within the body at any time, the heat-transfer rate at the body surface is given by

$$\dot{Q} = hA_s(T - T_\infty) = -\rho V(c_p) \left(\frac{dT}{dt} \right)$$

where

T = body temperature (K)

T_∞ = fluid temperature (K)

ρ = density of the body (kg/m³)

c_p = heat capacity of the body [J/(kg•K)]

t = time (s)

The temperature variation of the body with time is

$$T - T_\infty = (T_i - T_\infty)e^{-\beta t}$$

$$\beta = \frac{hA_s}{\rho V c_p}$$

where

$$\beta = \frac{1}{\tau}$$

τ = time constant (s)

The total heat transferred (Q_{total}) up to time t is

$$Q_{\text{total}} = \rho V c_p (T_i - T)$$

where T_i = initial body temperature (K)

Approximate Solution for Solid with Sudden Convection

The time dependence of the temperature at any location within the solid is the same as that of the midplane/centerline/centerpoint temperature T_o .

PLANE WALL

$$\text{For } Fo = \frac{\alpha t}{L^2} > 0.2$$

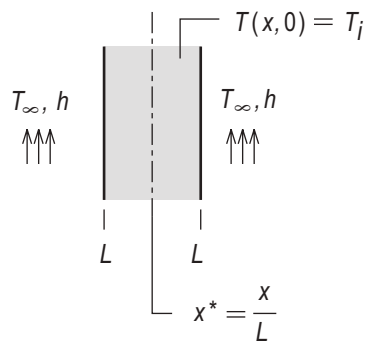

INFINITE CYLINDER AND SPHERE

$$\text{For } Fo = \frac{\alpha t}{r_o^2} > 0.2$$

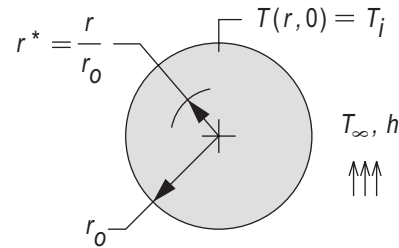

where

T_∞ = bulk fluid temperature

T_i = initial uniform temperature of solid

T_o = temperature at midplane of wall, centerline of cylinder, centerpoint of sphere at time t

L = half-thickness of plane wall

x = distance from midplane of wall

r_o = radius of cylinder/sphere

r = radial distance from centerline of cylinder/centerpoint of sphere

h = convective heat transfer coefficient

t = time

α = thermal diffusivity = $\frac{k}{\rho c}$

k = thermal conductivity of solid

ρ = density of solid

c = specific heat of solid

$$\frac{(T_o - T_\infty)}{(T_i - T_\infty)} = C_1 \exp(-\zeta_1^2 Fo)$$

where C_1 and ζ are obtained from the following table

Coefficients used in the one-term approximation to the series solutions for transient one-dimensional conduction						
Plane Wall			Infinite Cylinder		Sphere	
Bi^*	ζ_1 (rad)	C_1	ζ_1 (rad)	C_1	ζ_1 (rad)	C_1
0.01	0.0998	1.0017	0.1412	1.0025	0.1730	1.0030
0.02	0.1410	1.0033	0.1995	1.0050	0.2445	1.0060
0.03	0.1732	1.0049	0.2439	1.0075	0.2989	1.0090
0.04	0.1987	1.0066	0.2814	1.0099	0.3450	1.0120
0.05	0.2217	1.0082	0.3142	1.0124	0.3852	1.0149
0.06	0.2425	1.0098	0.3438	1.0148	0.4217	1.0179
0.07	0.2615	1.0114	0.3708	1.0173	0.4550	1.0209
0.08	0.2791	1.0130	0.3960	1.0197	0.4860	1.0239
0.09	0.2956	1.0145	0.4195	1.0222	0.5150	1.0268
0.10	0.3111	1.0160	0.4417	1.0246	0.5423	1.0298
0.15	0.3779	1.0237	0.5376	1.0365	0.6608	1.0445
0.20	0.4328	1.0311	0.6170	1.0483	0.7593	1.0592
0.25	0.4801	1.0382	0.6856	1.0598	0.8448	1.0737
0.30	0.5218	1.0450	0.7465	1.0712	0.9208	1.0880
0.40	0.5932	1.0580	0.8516	1.0932	1.0528	1.1164
0.50	0.6533	1.0701	0.9408	1.1143	1.1656	1.1441
0.60	0.7051	1.0814	1.0185	1.1346	1.2644	1.1713
0.70	0.7506	1.0919	1.0873	1.1539	1.3525	1.1978
0.80	0.7910	1.1016	1.1490	1.1725	1.4320	1.2236
0.90	0.8274	1.1107	1.2048	1.1902	1.5044	1.2488
1.0	0.8603	1.1191	1.2558	1.2071	1.5708	1.2732
2.0	1.0769	1.1795	1.5995	1.3384	2.0288	1.4793
3.0	1.1925	1.2102	1.7887	1.4191	2.2889	1.6227
4.0	1.2646	1.2287	1.9081	1.4698	2.4556	1.7201
5.0	1.3138	1.2402	1.9898	1.5029	2.5704	1.7870
6.0	1.3496	1.2479	2.0490	1.5253	2.6537	1.8338
7.0	1.3766	1.2532	2.0937	1.5411	2.7165	1.8674
8.0	1.3978	1.2570	2.1286	1.5526	1.7654	1.8921
9.0	1.4149	1.2598	2.1566	1.5611	2.8044	1.9106
10.0	1.4289	1.2620	2.1795	1.5677	2.8363	1.9249
20.0	1.4961	1.2699	2.2881	1.5919	2.9857	1.9781
30.0	1.5202	1.2717	2.3261	1.5973	3.0372	1.9898
40.0	1.5325	1.2723	2.3455	1.5993	3.0632	1.9942
50.0	1.5400	1.2727	2.3572	1.6002	3.0788	1.9962
100.0	1.5552	1.2731	2.3809	1.6015	3.1102	1.9990
∞	1.5707	1.2733	2.4050	1.6018	3.1415	2.0000

* $Bi = hL/k$ for the plane wall and hr_o/k for the infinite cylinder and sphere.

Incropera, Frank P. and David P. DeWitt, *Introduction to Heat Transfer*, 4th ed., John Wiley and Sons, 2002, pp. 256–261.

Fins

For a straight fin with uniform cross section (assuming negligible heat transfer from tip),

$$\dot{Q} = \sqrt{hPkA_c}(T_b - T_\infty)\tanh(mL_c)$$

where

h = convection heat-transfer coefficient of the fluid [W/(m²•K)]

P = perimeter of exposed fin cross section (m)

k = fin thermal conductivity [W/(m•K)]

A_c = fin cross-sectional area (m²)

T_b = temperature at base of fin (K)

T_∞ = fluid temperature (K)

$$m = \sqrt{\frac{hP}{kA_c}}$$

$$L_c = L + \frac{A_c}{P}, \text{ corrected length of fin (m)}$$

Rectangular Fin

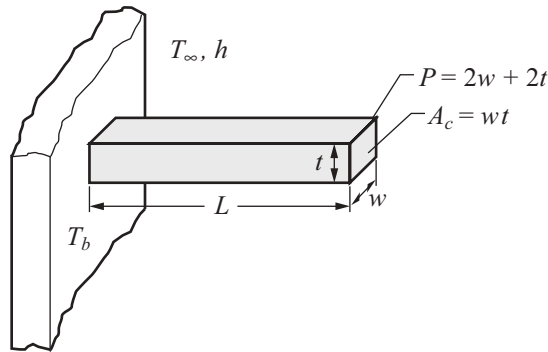

Pin Fin

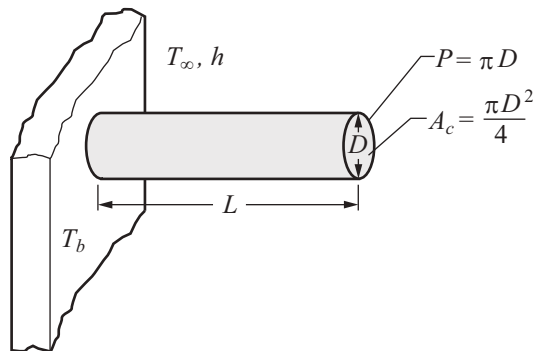

Convection

Terms

D = diameter (m)

\bar{h} = average convection heat-transfer coefficient of the fluid [W/(m²•K)]

L = length (m)

\overline{Nu} = average Nusselt number

Pr = Prandtl number = $\frac{c_p \mu}{k}$

u_m = mean velocity of fluid (m/s)

- u_∞ = free stream velocity of fluid (m/s)
- μ = dynamic viscosity of fluid [kg/(m•s)]
- ρ = density of fluid (kg/m³)

External Flow

In all cases, evaluate fluid properties at average temperature between that of the body and that of the flowing fluid.

Flat Plate of Length L in Parallel Flow

$$\text{Re}_L = \frac{\rho u_\infty L}{\mu}$$

$$\overline{Nu}_L = \frac{\overline{h}L}{k} = 0.6640 \text{Re}_L^{1/2} \text{Pr}^{1/3} \quad (\text{Re}_L < 10^5)$$

$$\overline{Nu}_L = \frac{\overline{h}L}{k} = 0.0366 \text{Re}_L^{0.8} \text{Pr}^{1/3} \quad (\text{Re}_L > 10^5)$$

Cylinder of Diameter D in Cross Flow

$$\text{Re}_D = \frac{\rho u_\infty D}{\mu}$$

$$\overline{Nu}_D = \frac{\overline{h}D}{k} = C \text{Re}_D^n \text{Pr}^{1/3}$$

where

Re_D	C	n
1 – 4	0.989	0.330
4 – 40	0.911	0.385
40 – 4,000	0.683	0.466
4,000 – 40,000	0.193	0.618
40,000 – 250,000	0.0266	0.805

Flow Over a Sphere of Diameter, D

$$\overline{Nu}_D = \frac{\overline{h}D}{k} = 2.0 + 0.60 \text{Re}_D^{1/2} \text{Pr}^{1/3}$$

($1 < \text{Re}_D < 70,000; 0.6 < \text{Pr} < 400$)

Internal Flow

$$\text{Re}_D = \frac{\rho u_m D}{\mu}$$

Laminar Flow in Circular Tubes

For laminar flow ($\text{Re}_D < 2300$), fully developed conditions

- $\text{Nu}_D = 4.36$ (uniform heat flux)
- $\text{Nu}_D = 3.66$ (constant surface temperature)

For laminar flow ($\text{Re}_D < 2300$), combined entry length with constant surface temperature

$$\text{Nu}_D = 1.86 \left(\frac{\text{Re}_D \text{Pr}}{\frac{L}{D}} \right)^{1/3} \left(\frac{\mu_b}{\mu_s} \right)^{0.14}$$

where

- L = length of tube (m)
- D = tube diameter (m)
- μ_b = dynamic viscosity of fluid [kg/(m•s)] at bulk temperature of fluid T_b
- μ_s = dynamic viscosity of fluid [kg/(m•s)] at inside surface temperature of the tube T_s

Turbulent Flow in Circular Tubes

Dittus-Boelter Equation

$$Nu_D = 0.023 Re_D^{4/5} Pr^n \quad \text{where} \quad \left[\begin{array}{l} 0.7 \leq Pr \leq 160 \\ Re_D \geq 10,000 \\ \frac{L}{D} \geq 10 \end{array} \right]$$

where

$$n = 0.4 \text{ for heating}$$

$$n = 0.3 \text{ for cooling}$$

should be used for small to moderate temperature differences

Sieder-Tate Equation

$$Nu_D = 0.027 Re_D^{4/5} Pr^{1/3} \left(\frac{\mu}{\mu_s} \right)^{0.14} \quad \text{where} \quad \left[\begin{array}{l} 0.7 \leq Pr \leq 16,700 \\ Re_D \geq 10,000 \\ \frac{L}{D} \geq 10 \end{array} \right]$$

should be used for flows characterized by large property variations.

Incropera, Frank P. and David P. DeWitt, *Fundamentals of Heat and Mass Transfer*, 3rd ed., Wiley, 1990, p. 496.

Noncircular Ducts

In place of the diameter, D , use the equivalent (hydraulic) diameter (D_H) defined as

$$D_H = \frac{4 \times \text{cross-sectional area}}{\text{wetted perimeter}}$$

Circular Annulus ($D_o > D_i$)

In place of the diameter, D , use the equivalent (hydraulic) diameter (D_H) defined as

$$D_H = D_o - D_i$$

Liquid Metals ($0.003 < Pr < 0.05$)

$$Nu_D = 6.3 + 0.0167 Re_D^{0.85} Pr^{0.93} \text{ (uniform heat flux)}$$

$$Nu_D = 7.0 + 0.025 Re_D^{0.8} Pr^{0.8} \text{ (constant wall temperature)}$$

Boiling

Evaporation occurring at a solid-liquid interface when

$$T_{\text{solid}} > T_{\text{sat, liquid}}$$

$$q'' = h(T_s - T_{\text{sat}}) = h\Delta T_e$$

where ΔT_e = excess temperature

Pool Boiling – Liquid is quiescent; motion near solid surface is due to free convection and mixing induced by bubble growth and detachment.

Forced Convection Boiling – Fluid motion is induced by external means in addition to free convection and bubble-induced mixing.

Sub-Cooled Boiling – Temperature of liquid is below saturation temperature; bubbles forming at surface may condense in the liquid.

Saturated Boiling – Liquid temperature slightly exceeds the saturation temperature; bubbles forming at the surface are propelled through liquid by buoyancy forces.

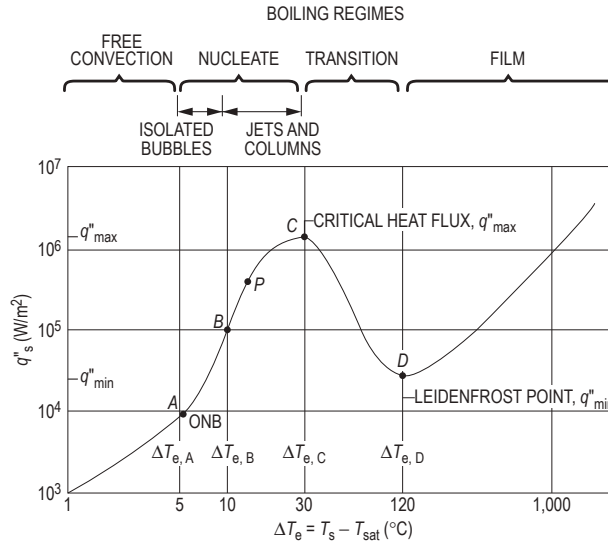

Incropera, Frank P. and David P. DeWitt, *Fundamentals of Heat and Mass Transfer*, 3rd ed., Wiley, 1990. Reproduced with permission of John Wiley & Sons, Inc.

Typical boiling curve for water at one atmosphere: surface heat flux q''_s as a function of excess temperature, $\Delta T_e = T_s - T_{sat}$
Free Convection Boiling – Insufficient vapor is in contact with the liquid phase to cause boiling at the saturation temperature.
Nucleate Boiling – Isolated bubbles form at nucleation sites and separate from surface; vapor escapes as jets or columns.

For nucleate boiling a widely used correlation was proposed in 1952 by Rohsenow:

$$\dot{q}_{nucleate} = \mu_l h_{fg} \left[\frac{g(\rho_l - \rho_v)}{\sigma} \right]^{1/2} \left[\frac{c_{pl}(T_s - T_{sat})}{C_{sf} h_{fg} Pr_l^n} \right]^3$$

where

- $\dot{q}_{nucleate}$ = nucleate boiling heat flux (W/m²)
- μ_l = viscosity of the liquid [kg/(m•s)]
- h_{fg} = enthalpy of vaporization (J/kg)
- g = gravitational acceleration (m/s²)
- ρ_l = density of the liquid (kg/m³)
- ρ_v = density of the vapor (kg/m³)
- σ = surface tension of liquid–vapor interface (N/m)
- c_{pl} = specific heat of the liquid [J/(kg•°C)]
- T_s = surface temperature of the heater (°C)
- T_{sat} = saturation temperature of the fluid (°C)
- C_{sf} = experimental constant that depends on surface–fluid combination
- Pr_l = Prandtl number of the liquid
- n = experimental constant that depends on the fluid

Çengel, Yunus A., *Heat and Mass Transfer: A Practical Approach*, 3rd ed., New York: McGraw-Hill, 2007.

Peak Heat Flux

The maximum (or critical) heat flux (CHF) in nucleate pool boiling:

$$\dot{q}_{max} = C_{cr} h_{fg} \left[\sigma g \rho_v^2 (\rho_l - \rho_v) \right]^{1/4}$$

C_{cr} is a constant whose value depends on the heater geometry, but generally is about 0.15.

The CHF is independent of the fluid–heating surface combination, as well as the viscosity, thermal conductivity, and specific heat of the liquid.

The CHF increases with pressure up to about one-third of the critical pressure, and then starts to decrease and becomes zero at the critical pressure.

The CHF is proportional to h_{fg} , and large maximum heat fluxes can be obtained using fluids with a large enthalpy of vaporization, such as water.

Values of the coefficient C_{cr} for maximum heat flux (dimensionless parameter $L^* = L[g(\rho_l - \rho_v)/\sigma]^{1/2}$)

Heater Geometry	C_{cr}	Charac. Dimension of Heater, L	Range of L^*
Large horizontal flat heater	0.149	Width or diameter	$L^* > 27$
Small horizontal flat heater ¹	$18.9 K_1$	Width or diameter	$9 < L^* < 20$
Large horizontal cylinder	0.12	Radius	$L^* > 1.2$
Small horizontal cylinder	$0.12 L^{*-0.25}$	Radius	$0.15 < L^* < 1.2$
Large sphere	0.11	Radius	$L^* > 4.26$
Small sphere	$0.227 L^{*-0.5}$	Radius	$0.15 < L^* < 4.26$

$$^1K_1 = \sigma/[g(\rho_l - \rho_v)A_{\text{heater}}]$$

Çengel, Yunus A., *Heat and Mass Transfer: A Practical Approach*, 3rd ed., New York: McGraw-Hill, 2007.

Minimum Heat Flux

Minimum heat flux, which occurs at the Leidenfrost point, it represents the lower limit for the heat flux in the film boiling regime.

Zuber derived the following expression for the minimum heat flux for a large horizontal plate

$$\dot{q}_{\min} = 0.09 \rho_v h_{fg} \left[\frac{\sigma g (\rho_l - \rho_v)}{(\rho_l + \rho_v)^2} \right]^{1/4}$$

The relation above can be in error by 50% or more.

Transition Boiling – Rapid bubble formation results in vapor film on surface and oscillation between film and nucleate boiling.

Film Boiling – Surface completely covered by vapor blanket; includes significant radiation through vapor film.

Çengel, Yunus A., *Heat and Mass Transfer: A Practical Approach*, 3rd ed., New York: McGraw-Hill, 2007.

Film Boiling

The heat flux for film boiling on a horizontal cylinder or sphere of diameter D is given by

$$\dot{q}_{\text{film}} = C_{\text{film}} \left[\frac{g k_v^3 \rho_v (\rho_l - \rho_v) [h_{fg} + 0.4 c_{pv} (T_s - T_{\text{sat}})]}{\mu_v D (T_s - T_{\text{sat}})} \right]^{1/4} (T_s - T_{\text{sat}})$$

$$C_{\text{film}} = \begin{cases} 0.62 & \text{for horizontal cylinders} \\ 0.67 & \text{for spheres} \end{cases}$$

Çengel, Yunus A., *Heat and Mass Transfer: A Practical Approach*, 3rd ed., New York: McGraw-Hill, 2007.

Film Condensation of a Pure Vapor

On a Vertical Surface

$$\overline{Nu}_L = \frac{\bar{h}L}{k_l} = 0.943 \left[\frac{\rho_l^2 g h_{fg} L^3}{\mu_l k_l (T_{sat} - T_s)} \right]^{0.25}$$

where

- ρ_l = density of liquid phase of fluid (kg/m³)
- g = gravitational acceleration (9.81 m/s²)
- h_{fg} = latent heat of vaporization (J/kg)
- L = length of surface (m)
- μ_l = dynamic viscosity of liquid phase of fluid [kg/(s•m)]
- k_l = thermal conductivity of liquid phase of fluid [W/(m•K)]
- T_{sat} = saturation temperature of fluid (K)
- T_s = temperature of vertical surface (K)

Note: Evaluate all liquid properties at the average temperature between the saturated temperature T_{sat} and the surface temperature T_s .

Outside Horizontal Tubes

$$\overline{Nu}_D = \frac{\bar{h}D}{k} = 0.729 \left[\frac{\rho_l^2 g h_{fg} D^3}{\mu_l k_l (T_{sat} - T_s)} \right]^{0.25}$$

where D = tube outside diameter (m)

Note: Evaluate all liquid properties at the average temperature between the saturated temperature T_{sat} and the surface temperature T_s .

Natural (Free) Convection

Vertical Flat Plate in Large Body of Stationary Fluid

Equation also can apply to vertical cylinder of sufficiently large diameter in large body of stationary fluid.

$$\bar{h} = C \left(\frac{k}{L} \right) Ra_L^n$$

where

L = length of the plate (cylinder) in the vertical direction

$$Ra_L = \text{Rayleigh Number} = \frac{g\beta(T_s - T_\infty)L^3}{\nu^2} Pr$$

T_s = surface temperature (K)

T_∞ = fluid temperature (K)

β = coefficient of thermal expansion (1/K)

(For an ideal gas: $\beta = \frac{2}{T_s + T_\infty}$ with T in absolute temperature)

ν = kinematic viscosity (m²/s)

Range of Ra_L	C	n
$10^4 - 10^9$	0.59	1/4
$10^9 - 10^{13}$	0.10	1/3

Long Horizontal Cylinder in Large Body of Stationary Fluid

$$\bar{h} = C \left(\frac{k}{D} \right) \text{Ra}_D^n$$

$$\text{Ra}_D = \frac{g\beta(T_s - T_\infty)D^3}{\nu^2} Pr$$

Ra_D	C	n
$10^{-3} - 10^2$	1.02	0.148
$10^2 - 10^4$	0.850	0.188
$10^4 - 10^7$	0.480	0.250
$10^7 - 10^{12}$	0.125	0.333

Heat Exchangers

The rate of heat transfer associated with either stream in a heat exchanger in which incompressible fluid or ideal gas with constant specific heats flows is

$$\dot{Q} = \dot{m}c_p(T_{\text{exit}} - T_{\text{inlet}})$$

where

c_p = specific heat (at constant pressure)

\dot{m} = mass flow rate

The rate of heat transfer in a heat exchanger is

$$\dot{Q} = UAF\Delta T_{lm}$$

where

A = any convenient reference area (m^2)

F = correction factor for log mean temperature difference for more complex heat exchangers (shell and tube arrangements with several tube or shell passes or cross-flow exchangers with mixed and unmixed flow); otherwise $F = 1$.

U = overall heat-transfer coefficient based on area A and the log mean temperature difference [$\text{W}/(\text{m}^2 \cdot \text{K})$]

ΔT_{lm} = log mean temperature difference (K)

Log Mean Temperature Difference (LMTD)

For *counterflow* in tubular heat exchangers

$$\Delta T_{lm} = \frac{(T_{Ho} - T_{Ci}) - (T_{Hi} - T_{Co})}{\ln \left(\frac{T_{Ho} - T_{Ci}}{T_{Hi} - T_{Co}} \right)}$$

For *parallel flow* in tubular heat exchangers

$$\Delta T_{lm} = \frac{(T_{Ho} - T_{Co}) - (T_{Hi} - T_{Ci})}{\ln \left(\frac{T_{Ho} - T_{Co}}{T_{Hi} - T_{Ci}} \right)}$$

where

ΔT_{lm} = log mean temperature difference (K)

T_{Hi} = inlet temperature of the hot fluid (K)

T_{Ho} = outlet temperature of the hot fluid (K)

T_{Ci} = inlet temperature of the cold fluid (K)

T_{Co} = outlet temperature of the cold fluid (K)

Heat Exchanger Effectiveness, ε

$$\varepsilon = \frac{\dot{Q}}{\dot{Q}_{\max}} = \frac{\text{actual heat transfer rate}}{\text{maximum possible heat transfer rate}}$$

$$\varepsilon = \frac{C_H(T_{Hi} - T_{Ho})}{C_{\min}(T_{Hi} - T_{Ci})} \quad \text{or} \quad \varepsilon = \frac{C_C(T_{Co} - T_{Ci})}{C_{\min}(T_{Hi} - T_{Ci})}$$

where

$C = \dot{m}c_p =$ heat capacity rate (W/K)

$C_{\min} =$ smaller of C_C or C_H

Number of Transfer Units (NTU)

$$NTU = \frac{UA}{C_{\min}}$$

Effectiveness-NTU Relations

$$C_r = \frac{C_{\min}}{C_{\max}} = \text{heat capacity ratio}$$

For *parallel flow concentric tube* heat exchanger

$$\varepsilon = \frac{1 - \exp[-NTU(1 + C_r)]}{1 + C_r}$$

$$NTU = - \frac{\ln[1 - \varepsilon(1 + C_r)]}{1 + C_r}$$

For *counterflow concentric tube* heat exchanger

$$\varepsilon = \frac{1 - \exp[-NTU(1 - C_r)]}{1 - C_r \exp[-NTU(1 - C_r)]} \quad (C_r < 1)$$

$$\varepsilon = \frac{NTU}{1 + NTU} \quad (C_r = 1)$$

$$NTU = \frac{1}{C_r - 1} \ln\left(\frac{\varepsilon - 1}{\varepsilon C_r - 1}\right) \quad (C_r < 1)$$

$$NTU = \frac{\varepsilon}{1 - \varepsilon} \quad (C_r = 1)$$

Overall Heat-Transfer Coefficient for Concentric Tube and Shell-and-Tube Heat Exchangers

$$\frac{1}{UA} = \frac{1}{h_i A_i} + \frac{R_{fi}}{A_i} + \frac{\ln\left(\frac{D_o}{D_i}\right)}{2\pi k L} + \frac{R_{fo}}{A_o} + \frac{1}{h_o A_o}$$

where

$A_i =$ inside area of tubes (m²)

$A_o =$ outside area of tubes (m²)

$D_i =$ inside diameter of tubes (m)

$D_o =$ outside diameter of tubes (m)

$h_i =$ convection heat-transfer coefficient for inside of tubes [W/(m²•K)]

$h_o =$ convection heat-transfer coefficient for outside of tubes [W/(m²•K)]

$k =$ thermal conductivity of tube material [W/(m•K)]

$R_{fi} =$ fouling factor for inside of tube [(m²•K)/W]

$R_{fo} =$ fouling factor for outside of tube [(m²•K)/W]

Radiation

Types of Bodies

Any Body

For any body

$$\alpha + \rho + \tau = 1$$

where

α = absorptivity (ratio of energy absorbed to incident energy)

ρ = reflectivity (ratio of energy reflected to incident energy)

τ = transmissivity (ratio of energy transmitted to incident energy)

Opaque Body

For an opaque body

$$\alpha + \rho = 1$$

Gray Body

A gray body is one for which

$$\alpha = \varepsilon, (0 < \alpha < 1; 0 < \varepsilon < 1)$$

where

ε = the emissivity of the body

For a gray body

$$\varepsilon + \rho = 1$$

Real bodies are frequently approximated as gray bodies.

Black body

A black body is defined as one that absorbs all energy incident upon it. It also emits radiation at the maximum rate for a body of a particular size at a particular temperature. For such a body

$$\alpha = \varepsilon = 1$$

Shape Factor (View Factor, Configuration Factor) Relations

Reciprocity Relations

$$A_i F_{ij} = A_j F_{ji}$$

where

A_i = surface area (m²) of surface i

F_{ij} = shape factor (view factor, configuration factor); fraction of the radiation leaving surface i that is intercepted by surface j ; $0 \leq F_{ij} \leq 1$

Summation Rule for N Surfaces

$$\sum_{j=1}^N F_{ij} = 1$$

Net Energy Exchange by Radiation between Two Bodies

Body Small Compared to its Surroundings

$$\dot{Q}_{12} = \epsilon \sigma A (T_1^4 - T_2^4)$$

where

\dot{Q}_{12} = net heat-transfer rate from the body (W)

ϵ = emissivity of the body

σ = Stefan-Boltzmann constant [$\sigma = 5.67 \times 10^{-8} \text{ W}/(\text{m}^2 \cdot \text{K}^4)$]

A = body surface area (m^2)

T_1 = absolute temperature (K) of the body surface

T_2 = absolute temperature (K) of the surroundings

Net Energy Exchange by Radiation between Two Black Bodies

The net energy exchange by radiation between two black bodies that see each other is given by

$$\dot{Q}_{12} = A_1 F_{12} \sigma (T_1^4 - T_2^4)$$

Net Energy Exchange by Radiation between Two Diffuse-Gray Surfaces that Form an Enclosure

Generalized Cases

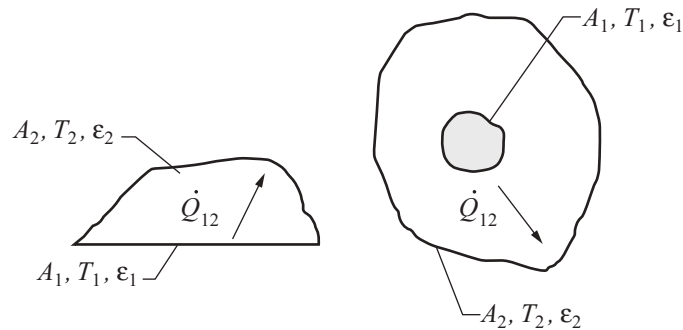

$$\dot{Q}_{12} = \frac{\sigma (T_1^4 - T_2^4)}{\frac{1 - \epsilon_1}{\epsilon_1 A_1} + \frac{1}{A_1 F_{12}} + \frac{1 - \epsilon_2}{\epsilon_2 A_2}}$$

One-Dimensional Geometry with Thin Low-Emissivity Shield
Inserted between Two Parallel Plates

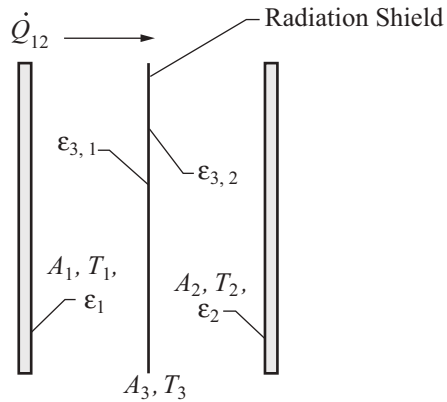

$$\dot{Q}_{12} = \frac{\sigma(T_1^4 - T_2^4)}{\frac{1 - \epsilon_1}{\epsilon_1 A_1} + \frac{1}{A_1 F_{13}} + \frac{1 - \epsilon_{3,1}}{\epsilon_{3,1} A_3} + \frac{1 - \epsilon_{3,2}}{\epsilon_{3,2} A_3} + \frac{1}{A_3 F_{32}} + \frac{1 - \epsilon_2}{\epsilon_2 A_2}}$$

Reradiating Surface

Reradiating Surfaces are considered to be insulated or adiabatic ($\dot{Q}_R = 0$).

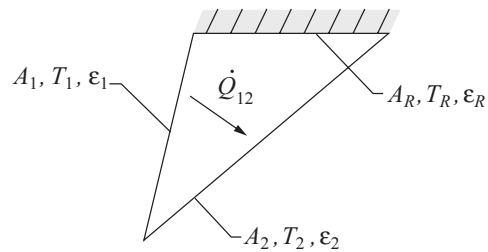

$$\dot{Q}_{12} = \frac{\sigma(T_1^4 - T_2^4)}{\frac{1 - \epsilon_1}{\epsilon_1 A_1} + \frac{1}{A_1 F_{12} + \left[\left(\frac{1}{A_1 F_{1R}} \right) + \left(\frac{1}{A_2 F_{2R}} \right) \right]^{-1}} + \frac{1 - \epsilon_2}{\epsilon_2 A_2}}$$

Instrumentation, Measurement, and Control

Measurement

Definitions

Calibration – the comparison of an instrument's output to accepted input reference values (for example, using a different instrument with known accuracy), including an evaluation of all the associated uncertainties. The formal definition of calibration is published in ISO/JCGM 200:2012.

Transducer – a device used to convert a physical parameter such as temperature, pressure, flow, light intensity, etc. into an electrical signal (also called a *sensor*).

Transducer Sensitivity – the ratio of change in electrical signal magnitude to the change in magnitude of the physical parameter being measured.

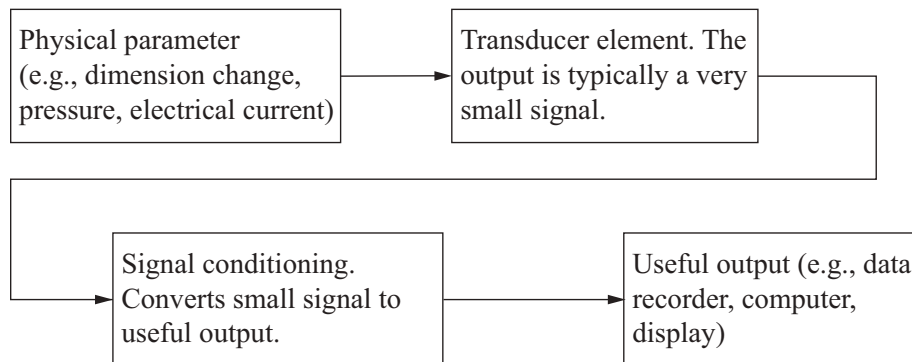

Temperature Sensors

Resistance Temperature Detector (RTD) – a device used to relate change in resistance to change in temperature. Typically made from platinum, the controlling equation for an RTD is given by:

$$R_T = R_0 [1 + \alpha(T - T_0)]$$

where

R_T = resistance of the RTD at temperature T (in °C)

R_0 = resistance of the RTD at the reference temperature T_0 (usually 0°C)

α = resistance temperature coefficient of the RTD (typically 0.00385 Ω/Ω per °C for platinum)

The following graph shows tolerance values as a function of temperature for 100- Ω RTDs.

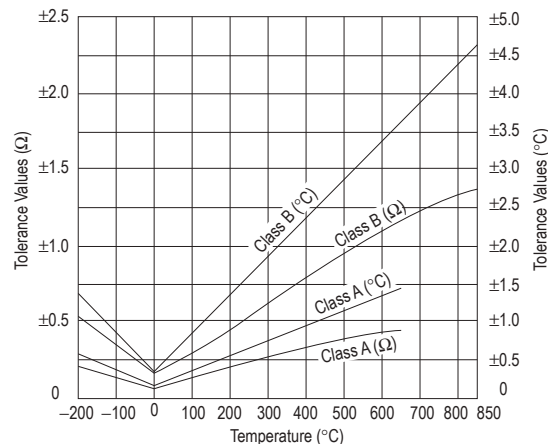

From Tempco Manufactured Products, as posted on www.tempco.com, July 2013.

Thermistors – Typically manufactured from a semiconductor, with a negative temperature coefficient.

The thermistor resistance is:

$$R_T = R_0 e^{\beta \left(\frac{1}{T} - \frac{1}{T_0} \right)}$$

where β is a material dependent value and T is in Kelvin.

The Steinhart-Hart equation is often provided as a more precise model for thermistors:

$$\frac{1}{T} = A + B \ln(R) + C (\ln(R))^3$$

Where the thermistor manufacturer will provide the coefficients A , B , and C . When R is in Ω and T is in Kelvin, a typical thermistor might have $A = 1.403 \times 10^{-3}$; $B = 2.373 \times 10^{-4}$; $C = 9.827 \times 10^{-8}$.

Thermocouple (TC) – a device using the Seebeck effect to sense temperature differences. A thermocouple consists of two dissimilar conductors in electrical contact a measured point and also at a reference junction; the voltage output is proportional to the difference in temperature between the measured point and the reference junction.

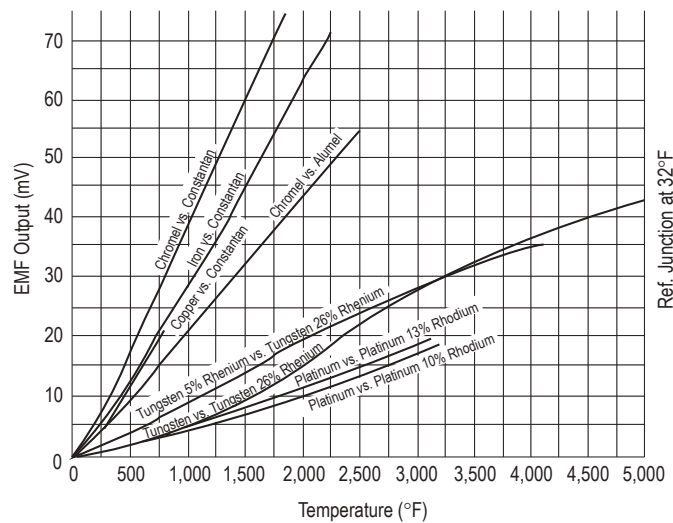

From Convectronics Inc., as posted on www.convectronics.com, July 2013.

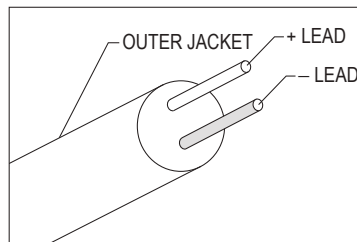

Typical Thermocouple (TC) Cable

From Convectronics Inc., as posted on www.convectronics.com, July 2013.

ANSI Code	Alloy Combination and Color		Outer Jacket Color		Maximum Thermocouple Temperature Range	Environment
	+ Lead	- Lead	Thermocouple Leads	Extension Cable		
J	IRON Fe (magnetic) White	CONSTANTAN COPPER-NICKEL Cu-Ni Red	Brown	Black	-346 to 2,193°F -210 to 1,200°C	Reducing, Vacuum, Inert. Limited Use in Oxidizing at High Temperatures. Not Recommended for Low Temperatures
K	NICKELCHROMIUM Ni-Cr Yellow	NICKEL-ALUMINUM Ni-Al (magnetic) Red	Brown	Yellow	-454 to 2,501°F -270 to 1,372°C	Clean Oxidizing and Inert. Limited Use in Vacuum or Reducing.
T	COPPER Cu Blue	CONSTANTAN COPPER-NICKEL Cu-Ni Red	Brown	Blue	-454 to 752°F -270 to 400°C	Mild Oxidizing, Reducing Vacuum or Inert. Good where moisture is present.
E	NICKELCHROMIUM Ni-Cr Purple	CONSTANTAN COPPER-NICKEL Cu-Ni Red	Brown	Purple	-454 to 1,832°F -270 to 1,000°C	Oxidizing or Inert. Limited Use in Vacuum or Reducing.

Strain Transducers

Strain Gauge – a device whose electrical resistance varies in proportion to the amount of strain in the device.

Gauge Factor (GF) – the ratio of fractional change in electrical resistance to the fractional change in length (strain):

$$GF = \frac{\Delta R/R}{\Delta L/L} = \frac{\Delta R/R}{\epsilon}$$

where

R = nominal resistance of the strain gauge at nominal length L

ΔR = change in resistance due the change in length ΔL

ϵ = normal strain sensed by the gauge

For metals, the change in resistance is due primarily to geometry. The gauge factor for metallic strain gauges is typically around 2.

Piezoresistive effect – a change in the intrinsic electrical conductivity of a material due to a mechanical strain. For many semiconductors, this leads to a gauge factor between 30 and 200 in strain transducers.

Piezoelectric effect – many crystalline or special ceramic materials convert mechanical energy to electrical energy. When a mechanical force is applied, the material changes dimension and an electric field is produced. Piezoelectric transducers can have many different geometries, including using multiple layers to increase gain. A simple peizoelectric transducer generates electrical charge that is proportional to the change in its ceramic's volume or will change volume proportional to an applied electric field. Dimensional changes are usually very small and can be predominantly in one dimension.

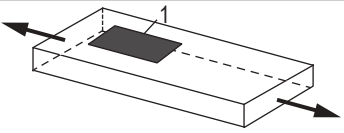
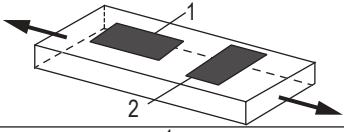
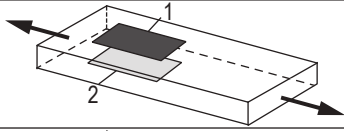
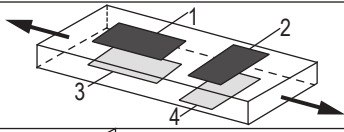
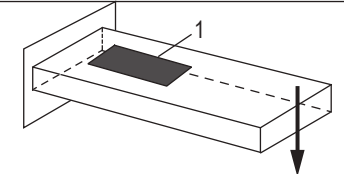
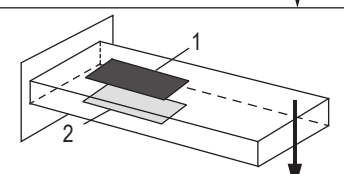
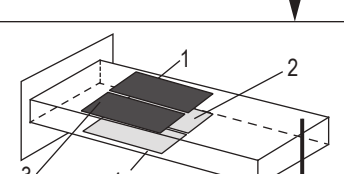
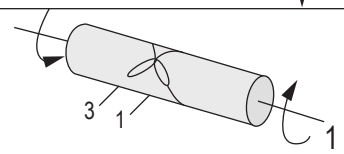
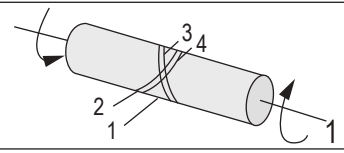
Strain	Gauge Setup	Bridge Type	Sensitivity mV/V @ 1,000 $\mu\epsilon$	Details
Axial		1/4	0.5	Good: Simplest to implement, but must use a dummy gauge if compensating for temperature. Also responds to bending strain.
		1/2	0.65	Better: Temperature compensated, but it is sensitive to bending strain.
		1/2	1.0	Better: Rejects bending strain, but not temperature. Must use dummy gauges if compensating for temperature.
		Full	1.3	Best: More sensitive and compensates for both temperature and bending strain.
Bending		1/4	0.5	Good: Simplest to implement, but must use a dummy gauge if compensating for temperature. Responds equally to axial strain.
		1/2	1.0	Better: Rejects axial strain and is temperature compensated.
		Full	2.0	Best: Rejects axial strain and is temperature compensated. Most sensitive to bending strain.
Torsional and Shear		1/2	1.0	Good: Gauges must be mounted at 45 degrees from centerline.
		Full	2.0	Best: Most sensitive full-bridge version of previous setup. Rejects both axial and bending strains.

Wheatstone Bridge – an electrical circuit used to measure changes in resistance.

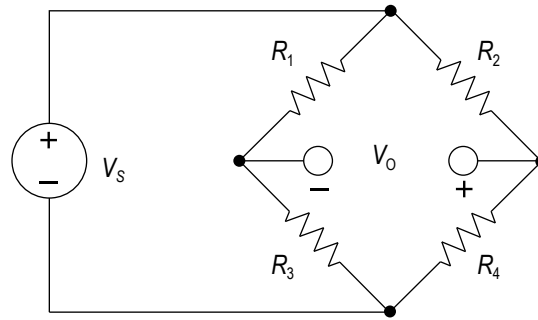

WHEATSTONE BRIDGE

If $\frac{R_1}{R_3} = \frac{R_2}{R_4}$ then $V_0 = 0 V$ and the bridge is said to be balanced.

If $R_1 = R_2 = R_3 = R$ and $R_4 = R + \Delta R$, where $\Delta R \ll R$, then

$$V_0 \approx \frac{\Delta R}{4R} \cdot V_s$$

Pressure Sensors

Pressure Sensors – can alternatively be called pressure transducers, pressure transmitters, pressure senders, pressure indicators, piezometers, and manometers. They are typically based on measuring the strain on a thin membrane due to an applied pressure.

Pressure Relative Measurement Types	Comparison
Absolute	Relative to 0 Pa, the pressure in a vacuum
Gauge	Relative to local atmospheric pressure
Differential	Relative to another pressurized source

From National Instruments Corporation, as posted on www.ni.com, July 2013.

pH Sensors

pH Sensor – a typical pH meter consists of a special measuring probe connected to an electronic meter that measures and displays the pH reading.

$$E_{el} = E^0 - S(\text{pH}_a - \text{pH}_i)$$

where

E_{el} = electrode potential

E^0 = zero potential

S = slope (mV per pH unit)

pH_a = pH value of the measured solution

pH_i = pH value of the internal buffer

From Alliance Technical Sales, Inc., as posted on www.alliancets.com, July 2013.

Examples of Common Chemical Sensors

Sensor Type	Principle	Materials	Analyte
Semiconducting oxide sensor	Conductivity impedance	SnO ₂ , TiO ₂ , ZnO ₂ , WO ₃ , polymers	O ₂ , H ₂ , CO, SO _x , NO _x , combustible hydrocarbons, alcohol, H ₂ S, NH ₃
Electrochemical sensor (liquid electrolyte)	Amperimetric	composite Pt, Au catalyst	H ₂ , O ₂ , O ₃ , CO, H ₂ S, SO ₂ , NO _x , NH ₃ , glucose, hydrazine
Ion-selective electrode (ISE)	Potentiometric	glass, LaF ₃ , CaF ₂	pH, K ⁺ , Na ⁺ , Cl ⁻ , Ca ²⁺ , Mg ²⁺ , F ⁻ , Ag ⁺
Solid electrode sensor	Amperimetric Potentiometric	YSZ, H ⁺ -conductor YSZ, β-alumina, Nasion, Nafion	O ₂ , H ₂ , CO, combustible hydrocarbons, O ₂ , H ₂ , CO ₂ , CO, NO _x , SO _x , H ₂ S, Cl ₂ H ₂ O, combustible hydrocarbons
Piezoelectric sensor	Mechanical w/ polymer film	quartz	combustible hydrocarbons, VOCs
Catalytic combustion sensor	Calorimetric	Pt/Al ₂ O ₃ , Pt-wire	H ₂ , CO, combustible hydrocarbons
Pyroelectric sensor	Calorimetric	Pyroelectric + film	Vapors
Optical sensors	Colorimetric fluorescence	optical fiber/indicator dye	Acids, bases, combustible hydrocarbons, biologicals

Reprinted with permission from *Journal of The Electrochemical Society*, 150 (2), ©2003, The Electrochemical Society.

Sampling

When a continuous-time or analog signal is sampled using a discrete-time method, certain basic concepts should be considered. The sampling rate or frequency is given by

$$f_s = \frac{1}{\Delta t}$$

Nyquist's (Shannon's) sampling theorem states that in order to accurately reconstruct the analog signal from the discrete sample points, the sample rate must be larger than twice the highest frequency contained in the measured signal. Denoting this frequency, which is called the Nyquist frequency, as f_N , the sampling theorem requires that

$$f_s > 2f_N$$

When the above condition is not met, the higher frequencies in the measured signal will not be accurately represented and will appear as lower frequencies in the sampled data. These are known as alias frequencies.

Analog-to-Digital Conversion

When converting an analog signal to digital form, the resolution of the conversion is an important factor. For a measured analog signal over the nominal range $[V_L, V_H]$, where V_L is the low end of the voltage range and V_H is the nominal high end of the voltage range, the voltage resolution is given by

$$\epsilon_V = \frac{V_H - V_L}{2^n}$$

where n is the number of conversion bits of the A/D converter with typical values of 4, 8, 10, 12, or 16. This number is a key design parameter. After converting an analog signal, the A/D converter produces an integer number of n bits. Call this number N . Note that the range of N is $[0, 2^n - 1]$. When calculating the discrete voltage, V , using the reading, N , from the A/D converter the following equation is used.

$$V = \epsilon_V N + V_L$$

Note that with this strategy, the highest measurable voltage is one voltage resolution less than V_H , or $V_H - \epsilon_V$.

Signal Conditioning

Signal conditioning of the measured analog signal is often required to prevent alias frequencies from being measured, and to reduce measurement errors.

Measurement Uncertainty

Measurement Accuracy is defined as “closeness of agreement between a measured quantity value and a true quantity value of a measurand.” [cite ISO JCGM 200:2012, definition 2.13]

Measurement Precision is defined as “closeness of agreement between indications or measured quantity values obtained by replicate measurements on the same or similar objects under specified conditions.” [cite ISO JCGM 200:2012, definition 2.15]

It is critical to always consider the measurement uncertainty of your instrumentation and processes when performing measurements. When reporting measurement results, it is necessary to provide an associated uncertainty so that those who use it may assess its reliability. The Engineering Probability and Statistics section provides a high-level overview of measurement uncertainty.

Suppose that a calculated result R depends on measurements whose values are $x_1 \pm w_1, x_2 \pm w_2, x_3 \pm w_3$, etc., where $R = f(x_1, x_2, x_3, \dots, x_n)$, x_i is the measured value, and w_i is the uncertainty in that value. The uncertainty in R , w_R , can be estimated using the Kline-McClintock equation:

$$w_R = \sqrt{\left(w_1 \frac{\partial f}{\partial x_1}\right)^2 + \left(w_2 \frac{\partial f}{\partial x_2}\right)^2 + \dots + \left(w_n \frac{\partial f}{\partial x_n}\right)^2}$$

Control Systems

The linear time-invariant transfer function model represented by the block diagram

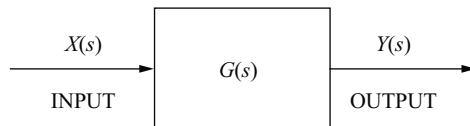

can be expressed as the ratio of two polynomials in the form

$$\frac{Y(s)}{X(s)} = G(s) = \frac{N(s)}{D(s)} = K \frac{\prod_{m=1}^M (s - z_m)}{\prod_{n=1}^N (s - p_n)}$$

where the M zeros, z_m , and the N poles, p_n , are the roots of the numerator polynomial, $N(s)$, and the denominator polynomial, $D(s)$, respectively.

One classical negative feedback control system model block diagram is

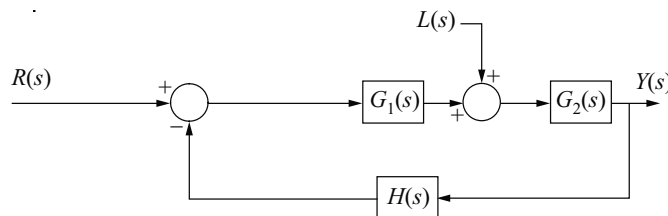

where $G_1(s)$ is a controller or compensator, $G_2(s)$ represents a plant model, and $H(s)$ represents the measurement dynamics. $Y(s)$ represents the controlled variable, $R(s)$ represents the reference input, and $L(s)$ represents a disturbance. $Y(s)$ is related to $R(s)$ and $L(s)$ by

$$Y(s) = \frac{G_1(s)G_2(s)}{1 + G_1(s)G_2(s)H(s)}R(s) + \frac{G_2(s)}{1 + G_1(s)G_2(s)H(s)}L(s)$$

$G_1(s) G_2(s) H(s)$ is the open-loop transfer function. The closed-loop characteristic equation is

$$1 + G_1(s) G_2(s) H(s) = 0$$

System performance studies normally include

1. Steady-state analysis using constant inputs based on the Final Value Theorem. If all poles of a $G(s)$ function have negative real parts, then

$$\text{dc gain} = \lim_{s \rightarrow 0} G(s)$$

Note that $G(s)$ could refer to either an open-loop or a closed-loop transfer function.

For the unity feedback control system model

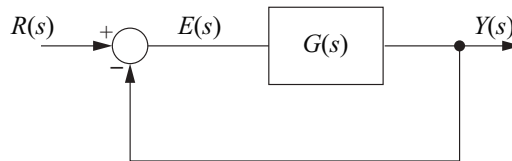

with the open-loop transfer function defined by

$$G(s) = \frac{K_B}{s^T} \times \frac{\prod_{m=1}^M (1 + s/\omega_m)}{\prod_{n=1}^N (1 + s/\omega_n)}$$

The following steady-state error analysis table can be constructed where T denotes the type of system, i.e., type 0, type 1, etc.

Steady-State Error e_{ss}				
Input \ Type	Type	$T = 0$	$T = 1$	$T = 2$
Unit Step		$1/(K_B + 1)$	0	0
Ramp		∞	$1/K_B$	0
Acceleration		∞	∞	$1/K_B$

2. Frequency response evaluations to determine dynamic performance and stability. For example, relative stability can be quantified in terms of

- a. Gain margin (GM), which is the additional gain required to produce instability in the unity gain feedback control system.

If at $\omega = \omega_{180}$,

$$\angle G(j\omega_{180}) = -180^\circ; \text{ then}$$

$$\text{GM} = -20 \log_{10} (|G(j\omega_{180})|)$$

- b. Phase margin (PM), which is the additional phase required to produce instability. Thus,

$$\text{PM} = 180^\circ + \angle G(j\omega_{0dB})$$

where ω_{0dB} is the ω that satisfies $|G(j\omega)| = 1$.

3. Transient responses are obtained by using Laplace transforms or computer solutions with numerical integration.

Common Compensator/Controller forms are

PID Controller $G_C(s) = K \left(1 + \frac{1}{T_I s} + T_D s \right)$

Lag or Lead Compensator $G_C(s) = K \left(\frac{1 + sT_1}{1 + sT_2} \right)$ depending on the ratio of T_1/T_2 .

First-Order Control System Models

The transfer function model for a first-order system is

$$\frac{Y(s)}{R(s)} = \frac{K}{\tau s + 1}$$

where

K = steady-state gain

τ = time constant

The step response of a first-order system to a step input of magnitude M is

$$y(t) = y_0 e^{-t/\tau} + KM(1 - e^{-t/\tau})$$

In the chemical process industry, y_0 is typically taken to be zero, and $y(t)$ is referred to as a deviation variable.

For systems with time delay (dead time or transport lag) θ , the transfer function is

$$\frac{Y(s)}{R(s)} = \frac{K e^{-\theta s}}{\tau s + 1}$$

The step response for $t \geq \theta$ to a step of magnitude M is

where

$$y(t) = \left[y_0 e^{-(t-\theta)/\tau} + KM(1 - e^{-(t-\theta)/\tau}) \right] u(t - \theta)$$

$u(t)$ is the unit step function.

Second-Order Control System Models

One standard second-order control system model is

$$\frac{Y(s)}{R(s)} = \frac{K \omega_n^2}{s^2 + 2\zeta \omega_n s + \omega_n^2}$$

where

K = steady-state gain

ζ = damping ratio

ω_n = undamped natural ($\zeta = 0$) frequency

$\omega_d = \omega_n \sqrt{1 - \zeta^2}$, the damped natural frequency

$\omega_r = \omega_n \sqrt{1 - 2\zeta^2}$, the damped resonant frequency

If the damping ratio ζ is less than unity, the system is said to be underdamped; if ζ is equal to unity, it is said to be critically damped; and if ζ is greater than unity, the system is said to be overdamped.

For a unit step input to a normalized underdamped second-order control system, the time required to reach a peak value t_p and the value of that peak M_p are given by

$$t_p = \pi / (\omega_n \sqrt{1 - \zeta^2})$$

$$M_p = 1 + e^{-\pi \zeta / \sqrt{1 - \zeta^2}}$$

The percent overshoot (% OS) of the response is given by

$$\% \text{ OS} = 100 e^{-\pi \zeta / \sqrt{1 - \zeta^2}}$$

For an underdamped second-order system, the logarithmic decrement is

$$\delta = \frac{1}{m} \ln\left(\frac{x_k}{x_{k+m}}\right) = \frac{2\pi\zeta}{\sqrt{1-\zeta^2}}$$

where x_k and x_{k+m} are the amplitudes of oscillation at cycles k and $k+m$, respectively. The period of oscillation τ is related to ω_d by

$$\omega_d \tau = 2\pi$$

The time required for the output of a second-order system to settle to within 2% of its final value (2% settling time) is defined to be

$$T_s = \frac{4}{\zeta\omega_n}$$

An alternative form commonly employed in the chemical process industry is

$$\frac{Y(s)}{R(s)} = \frac{K}{\tau^2 s^2 + 2\zeta\tau s + 1}$$

where

K = steady-state gain

ζ = the damping ratio

τ = the inverse natural frequency

Engineering Economics

Factor Name	Converts	Symbol	Formula
Single Payment Compound Amount	to F given P	$(F/P, i\%, n)$	$(1 + i)^n$
Single Payment Present Worth	to P given F	$(P/F, i\%, n)$	$(1 + i)^{-n}$
Uniform Series Sinking Fund	to A given F	$(A/F, i\%, n)$	$\frac{i}{(1 + i)^n - 1}$
Capital Recovery	to A given P	$(A/P, i\%, n)$	$\frac{i(1 + i)^n}{(1 + i)^n - 1}$
Uniform Series Compound Amount	to F given A	$(F/A, i\%, n)$	$\frac{(1 + i)^n - 1}{i}$
Uniform Series Present Worth	to P given A	$(P/A, i\%, n)$	$\frac{(1 + i)^n - 1}{i(1 + i)^n}$
Uniform Gradient Present Worth	to P given G	$(P/G, i\%, n)$	$\frac{(1 + i)^n - 1}{i^2(1 + i)^n} - \frac{n}{i(1 + i)^n}$
Uniform Gradient † Future Worth	to F given G	$(F/G, i\%, n)$	$\frac{(1 + i)^n - 1}{i^2} - \frac{n}{i}$
Uniform Gradient Uniform Series	to A given G	$(A/G, i\%, n)$	$\frac{1}{i} - \frac{n}{(1 + i)^n - 1}$

Nomenclature and Definitions

A Uniform amount per interest period
 B Benefit
 BV Book value
 C Cost
 d Inflation adjusted interest rate per interest period
 D_j Depreciation in year j
 EV Expected value
 F Future worth, value, or amount
 f General inflation rate per interest period
 G Uniform gradient amount per interest period
 i Interest rate per interest period
 i_e Annual effective interest rate
MARR..... Minimum acceptable/attractive rate of return
 m Number of compounding periods per year
 n Number of compounding periods; or the expected life of an asset
 P Present worth, value, or amount
 r Nominal annual interest rate
 S_n Expected salvage value in year n

Subscripts

j at time j
 n at time n
† $F/G = (F/A - n)/i = (F/A) \times (A/G)$

Non-Annual Compounding

$$i_e = \left(1 + \frac{r}{m}\right)^m - 1$$

Breakeven Analysis

By altering the value of any one of the variables in a situation, holding all of the other values constant, it is possible to find a value for that variable that makes the two alternatives equally economical. This value is the breakeven point.

Breakeven analysis is used to describe the percentage of capacity of operation for a manufacturing plant at which income will just cover expenses.

The payback period is the period of time required for the profit or other benefits of an investment to equal the cost of the investment.

Inflation

To account for inflation, the dollars are deflated by the general inflation rate per interest period f , and then they are shifted over the time scale using the interest rate per interest period i . Use an inflation adjusted interest rate per interest period d for computing present worth values P .

The formula for d is $d = i + f + (i \times f)$

Depreciation

Straight Line

$$D_j = \frac{C - S_n}{n}$$

Modified Accelerated Cost Recovery System (MACRS)

$$D_j = (\text{factor}) C$$

A table of MACRS factors is provided below.

Book Value

$$BV = \text{initial cost} - \sum D_j$$

Taxation

Income taxes are paid at a specific rate on taxable income. Taxable income is total income less depreciation and ordinary expenses. Expenses do not include capital items, which should be depreciated.

Capitalized Costs

Capitalized costs are present worth values using an assumed perpetual period of time.

$$\text{Capitalized Costs} = P = \frac{A}{i}$$

Bonds

Bond value equals the present worth of the payments the purchaser (or holder of the bond) receives during the life of the bond at some interest rate i .

Bond yield equals the computed interest rate of the bond value when compared with the bond cost.

Rate-of-Return

The minimum acceptable rate-of-return (MARR) is that interest rate that one is willing to accept, or the rate one desires to earn on investments. The rate-of-return on an investment is the interest rate that makes the benefits and costs equal.

Benefit-Cost Analysis

In a benefit-cost analysis, the benefits B of a project should exceed the estimated costs C .

$$B - C \geq 0, \text{ or } B/C \geq 1$$

Modified Accelerated Cost Recovery System (MACRS)

MACRS FACTORS				
Year	Recovery Period (Years)			
	3	5	7	10
	Recovery Rate (Percent)			
1	33.33	20.00	14.29	10.00
2	44.45	32.00	24.49	18.00
3	14.81	19.20	17.49	14.40
4	7.41	11.52	12.49	11.52
5		11.52	8.93	9.22
6		5.76	8.92	7.37
7			8.93	6.55
8			4.46	6.55
9				6.56
10				6.55
11				3.28

Economic Decision Trees

The following symbols are used to model decisions with decision trees:

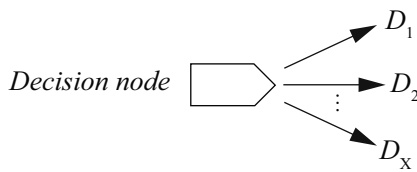

Decision maker chooses 1 of the available paths.

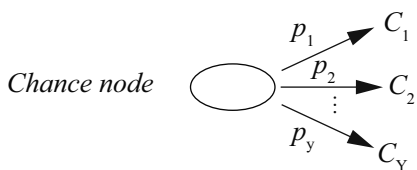

Represents a probabilistic (chance) event. Each possible outcome (C_1, C_2, \dots, C_Y) has a probability (p_1, p_2, \dots, p_Y) associated with it.

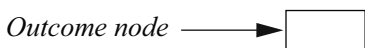

Shows result for a particular path through the decision tree.

Expected Value: $EV = (C_1)(p_1) + (C_2)(p_2) + \dots$

Interest Rate Tables
Factor Table - $i = 0.50\%$

n	P/F	P/A	P/G	F/P	F/A	A/P	A/F	A/G
1	0.9950	0.9950	0.0000	1.0050	1.0000	1.0050	1.0000	0.0000
2	0.9901	1.9851	0.9901	1.0100	2.0050	0.5038	0.4988	0.4988
3	0.9851	2.9702	2.9604	1.0151	3.0150	0.3367	0.3317	0.9967
4	0.9802	3.9505	5.9011	1.0202	4.0301	0.2531	0.2481	1.4938
5	0.9754	4.9259	9.8026	1.0253	5.0503	0.2030	0.1980	1.9900
6	0.9705	5.8964	14.6552	1.0304	6.0755	0.1696	0.1646	2.4855
7	0.9657	6.8621	20.4493	1.0355	7.1059	0.1457	0.1407	2.9801
8	0.9609	7.8230	27.1755	1.0407	8.1414	0.1278	0.1228	3.4738
9	0.9561	8.7791	34.8244	1.0459	9.1821	0.1139	0.1089	3.9668
10	0.9513	9.7304	43.3865	1.0511	10.2280	0.1028	0.0978	4.4589
11	0.9466	10.6770	52.8526	1.0564	11.2792	0.0937	0.0887	4.9501
12	0.9419	11.6189	63.2136	1.0617	12.3356	0.0861	0.0811	5.4406
13	0.9372	12.5562	74.4602	1.0670	13.3972	0.0796	0.0746	5.9302
14	0.9326	13.4887	86.5835	1.0723	14.4642	0.0741	0.0691	6.4190
15	0.9279	14.4166	99.5743	1.0777	15.5365	0.0694	0.0644	6.9069
16	0.9233	15.3399	113.4238	1.0831	16.6142	0.0652	0.0602	7.3940
17	0.9187	16.2586	128.1231	1.0885	17.6973	0.0615	0.0565	7.8803
18	0.9141	17.1728	143.6634	1.0939	18.7858	0.0582	0.0532	8.3658
19	0.9096	18.0824	160.0360	1.0994	19.8797	0.0553	0.0503	8.8504
20	0.9051	18.9874	177.2322	1.1049	20.9791	0.0527	0.0477	9.3342
21	0.9006	19.8880	195.2434	1.1104	22.0840	0.0503	0.0453	9.8172
22	0.8961	20.7841	214.0611	1.1160	23.1944	0.0481	0.0431	10.2993
23	0.8916	21.6757	233.6768	1.1216	24.3104	0.0461	0.0411	10.7806
24	0.8872	22.5629	254.0820	1.1272	25.4320	0.0443	0.0393	11.2611
25	0.8828	23.4456	275.2686	1.1328	26.5591	0.0427	0.0377	11.7407
30	0.8610	27.7941	392.6324	1.1614	32.2800	0.0360	0.0310	14.1265
40	0.8191	36.1722	681.3347	1.2208	44.1588	0.0276	0.0226	18.8359
50	0.7793	44.1428	1,035.6966	1.2832	56.6452	0.0227	0.0177	23.4624
60	0.7414	51.7256	1,448.6458	1.3489	69.7700	0.0193	0.0143	28.0064
100	0.6073	78.5426	3,562.7934	1.6467	129.3337	0.0127	0.0077	45.3613

Factor Table - $i = 1.00\%$

n	P/F	P/A	P/G	F/P	F/A	A/P	A/F	A/G
1	0.9901	0.9901	0.0000	1.0100	1.0000	1.0100	1.0000	0.0000
2	0.9803	1.9704	0.9803	1.0201	2.0100	0.5075	0.4975	0.4975
3	0.9706	2.9410	2.9215	1.0303	3.0301	0.3400	0.3300	0.9934
4	0.9610	3.9020	5.8044	1.0406	4.0604	0.2563	0.2463	1.4876
5	0.9515	4.8534	9.6103	1.0510	5.1010	0.2060	0.1960	1.9801
6	0.9420	5.7955	14.3205	1.0615	6.1520	0.1725	0.1625	2.4710
7	0.9327	6.7282	19.9168	1.0721	7.2135	0.1486	0.1386	2.9602
8	0.9235	7.6517	26.3812	1.0829	8.2857	0.1307	0.1207	3.4478
9	0.9143	8.5650	33.6959	1.0937	9.3685	0.1167	0.1067	3.9337
10	0.9053	9.4713	41.8435	1.1046	10.4622	0.1056	0.0956	4.4179
11	0.8963	10.3676	50.8067	1.1157	11.5668	0.0965	0.0865	4.9005
12	0.8874	11.2551	60.5687	1.1268	12.6825	0.0888	0.0788	5.3815
13	0.8787	12.1337	71.1126	1.1381	13.8093	0.0824	0.0724	5.8607
14	0.8700	13.0037	82.4221	1.1495	14.9474	0.0769	0.0669	6.3384
15	0.8613	13.8651	94.4810	1.1610	16.0969	0.0721	0.0621	6.8143
16	0.8528	14.7179	107.2734	1.1726	17.2579	0.0679	0.0579	7.2886
17	0.8444	15.5623	120.7834	1.1843	18.4304	0.0643	0.0543	7.7613
18	0.8360	16.3983	134.9957	1.1961	19.6147	0.0610	0.0510	8.2323
19	0.8277	17.2260	149.8950	1.2081	20.8109	0.0581	0.0481	8.7017
20	0.8195	18.0456	165.4664	1.2202	22.0190	0.0554	0.0454	9.1694
21	0.8114	18.8570	181.6950	1.2324	23.2392	0.0530	0.0430	9.6354
22	0.8034	19.6604	198.5663	1.2447	24.4716	0.0509	0.0409	10.0998
23	0.7954	20.4558	216.0660	1.2572	25.7163	0.0489	0.0389	10.5626
24	0.7876	21.2434	234.1800	1.2697	26.9735	0.0471	0.0371	11.0237
25	0.7798	22.0232	252.8945	1.2824	28.2432	0.0454	0.0354	11.4831
30	0.7419	25.8077	355.0021	1.3478	34.7849	0.0387	0.0277	13.7557
40	0.6717	32.8347	596.8561	1.4889	48.8864	0.0305	0.0205	18.1776
50	0.6080	39.1961	879.4176	1.6446	64.4632	0.0255	0.0155	22.4363
60	0.5504	44.9550	1,192.8061	1.8167	81.6697	0.0222	0.0122	26.5333
100	0.3697	63.0289	2,605.7758	2.7048	170.4814	0.0159	0.0059	41.3426

Interest Rate Tables
Factor Table - $i = 1.50\%$

n	P/F	P/A	P/G	F/P	F/A	A/P	A/F	A/G
1	0.9852	0.9852	0.0000	1.0150	1.0000	1.0150	1.0000	0.0000
2	0.9707	1.9559	0.9707	1.0302	2.0150	0.5113	0.4963	0.4963
3	0.9563	2.9122	2.8833	1.0457	3.0452	0.3434	0.3284	0.9901
4	0.9422	3.8544	5.7098	1.0614	4.0909	0.2594	0.2444	1.4814
5	0.9283	4.7826	9.4229	1.0773	5.1523	0.2091	0.1941	1.9702
6	0.9145	5.6972	13.9956	1.0934	6.2296	0.1755	0.1605	2.4566
7	0.9010	6.5982	19.4018	1.1098	7.3230	0.1516	0.1366	2.9405
8	0.8877	7.4859	26.6157	1.1265	8.4328	0.1336	0.1186	3.4219
9	0.8746	8.3605	32.6125	1.1434	9.5593	0.1196	0.1046	3.9008
10	0.8617	9.2222	40.3675	1.1605	10.7027	0.1084	0.0934	4.3772
11	0.8489	10.0711	48.8568	1.1779	11.8633	0.0993	0.0843	4.8512
12	0.8364	10.9075	58.0571	1.1956	13.0412	0.0917	0.0767	5.3227
13	0.8240	11.7315	67.9454	1.2136	14.2368	0.0852	0.0702	5.7917
14	0.8118	12.5434	78.4994	1.2318	15.4504	0.0797	0.0647	6.2582
15	0.7999	13.3432	89.6974	1.2502	16.6821	0.0749	0.0599	6.7223
16	0.7880	14.1313	101.5178	1.2690	17.9324	0.0708	0.0558	7.1839
17	0.7764	14.9076	113.9400	1.2880	19.2014	0.0671	0.0521	7.6431
18	0.7649	15.6726	126.9435	1.3073	20.4894	0.0638	0.0488	8.0997
19	0.7536	16.4262	140.5084	1.3270	21.7967	0.0609	0.0459	8.5539
20	0.7425	17.1686	154.6154	1.3469	23.1237	0.0582	0.0432	9.0057
21	0.7315	17.9001	169.2453	1.3671	24.4705	0.0559	0.0409	9.4550
22	0.7207	18.6208	184.3798	1.3876	25.8376	0.0537	0.0387	9.9018
23	0.7100	19.3309	200.0006	1.4084	27.2251	0.0517	0.0367	10.3462
24	0.6995	20.0304	216.0901	1.4295	28.6335	0.0499	0.0349	10.7881
25	0.6892	20.7196	232.6310	1.4509	30.0630	0.0483	0.0333	11.2276
30	0.6398	24.0158	321.5310	1.5631	37.5387	0.0416	0.0266	13.3883
40	0.5513	29.9158	524.3568	1.8140	54.2679	0.0334	0.0184	17.5277
50	0.4750	34.9997	749.9636	2.1052	73.6828	0.0286	0.0136	21.4277
60	0.4093	39.3803	988.1674	2.4432	96.2147	0.0254	0.0104	25.0930
100	0.2256	51.6247	1,937.4506	4.4320	228.8030	0.0194	0.0044	37.5295

Factor Table - $i = 2.00\%$

n	P/F	P/A	P/G	F/P	F/A	A/P	A/F	A/G
1	0.9804	0.9804	0.0000	1.0200	1.0000	1.0200	1.0000	0.0000
2	0.9612	1.9416	0.9612	1.0404	2.0200	0.5150	0.4950	0.4950
3	0.9423	2.8839	2.8458	1.0612	3.0604	0.3468	0.3268	0.9868
4	0.9238	3.8077	5.6173	1.0824	4.1216	0.2626	0.2426	1.4752
5	0.9057	4.7135	9.2403	1.1041	5.2040	0.2122	0.1922	1.9604
6	0.8880	5.6014	13.6801	1.1262	6.3081	0.1785	0.1585	2.4423
7	0.8706	6.4720	18.9035	1.1487	7.4343	0.1545	0.1345	2.9208
8	0.8535	7.3255	24.8779	1.1717	8.5830	0.1365	0.1165	3.3961
9	0.8368	8.1622	31.5720	1.1951	9.7546	0.1225	0.1025	3.8681
10	0.8203	8.9826	38.9551	1.2190	10.9497	0.1113	0.0913	4.3367
11	0.8043	9.7868	46.9977	1.2434	12.1687	0.1022	0.0822	4.8021
12	0.7885	10.5753	55.6712	1.2682	13.4121	0.0946	0.0746	5.2642
13	0.7730	11.3484	64.9475	1.2936	14.6803	0.0881	0.0681	5.7231
14	0.7579	12.1062	74.7999	1.3195	15.9739	0.0826	0.0626	6.1786
15	0.7430	12.8493	85.2021	1.3459	17.2934	0.0778	0.0578	6.6309
16	0.7284	13.5777	96.1288	1.3728	18.6393	0.0737	0.0537	7.0799
17	0.7142	14.2919	107.5554	1.4002	20.0121	0.0700	0.0500	7.5256
18	0.7002	14.9920	119.4581	1.4282	21.4123	0.0667	0.0467	7.9681
19	0.6864	15.6785	131.8139	1.4568	22.8406	0.0638	0.0438	8.4073
20	0.6730	16.3514	144.6003	1.4859	24.2974	0.0612	0.0412	8.8433
21	0.6598	17.0112	157.7959	1.5157	25.7833	0.0588	0.0388	9.2760
22	0.6468	17.6580	171.3795	1.5460	27.2990	0.0566	0.0366	9.7055
23	0.6342	18.2922	185.3309	1.5769	28.8450	0.0547	0.0347	10.1317
24	0.6217	18.9139	199.6305	1.6084	30.4219	0.0529	0.0329	10.5547
25	0.6095	19.5235	214.2592	1.6406	32.0303	0.0512	0.0312	10.9745
30	0.5521	22.3965	291.7164	1.8114	40.5681	0.0446	0.0246	13.0251
40	0.4529	27.3555	461.9931	2.2080	60.4020	0.0366	0.0166	16.8885
50	0.3715	31.4236	642.3606	2.6916	84.5794	0.0318	0.0118	20.4420
60	0.3048	34.7609	823.6975	3.2810	114.0515	0.0288	0.0088	23.6961
100	0.1380	43.0984	1,464.7527	7.2446	312.2323	0.0232	0.0032	33.9863

Interest Rate Tables
Factor Table - $i = 4.00\%$

n	P/F	P/A	P/G	F/P	F/A	A/P	A/F	A/G
1	0.9615	0.9615	0.0000	1.0400	1.0000	1.0400	1.0000	0.0000
2	0.9246	1.8861	0.9246	1.0816	2.0400	0.5302	0.4902	0.4902
3	0.8890	2.7751	2.7025	1.1249	3.1216	0.3603	0.3203	0.9739
4	0.8548	3.6299	5.2670	1.1699	4.2465	0.2755	0.2355	1.4510
5	0.8219	4.4518	8.5547	1.2167	5.4163	0.2246	0.1846	1.9216
6	0.7903	5.2421	12.5062	1.2653	6.6330	0.1908	0.1508	2.3857
7	0.7599	6.0021	17.0657	1.3159	7.8983	0.1666	0.1266	2.8433
8	0.7307	6.7327	22.1806	1.3686	9.2142	0.1485	0.1085	3.2944
9	0.7026	7.4353	27.8013	1.4233	10.5828	0.1345	0.0945	3.7391
10	0.6756	8.1109	33.8814	1.4802	12.0061	0.1233	0.0833	4.1773
11	0.6496	8.7605	40.3772	1.5395	13.4864	0.1141	0.0741	4.6090
12	0.6246	9.3851	47.2477	1.6010	15.0258	0.1066	0.0666	5.0343
13	0.6006	9.9856	54.4546	1.6651	16.6268	0.1001	0.0601	5.4533
14	0.5775	10.5631	61.9618	1.7317	18.2919	0.0947	0.0547	5.8659
15	0.5553	11.1184	69.7355	1.8009	20.0236	0.0899	0.0499	6.2721
16	0.5339	11.6523	77.7441	1.8730	21.8245	0.0858	0.0458	6.6720
17	0.5134	12.1657	85.9581	1.9479	23.6975	0.0822	0.0422	7.0656
18	0.4936	12.6593	94.3498	2.0258	25.6454	0.0790	0.0390	7.4530
19	0.4746	13.1339	102.8933	2.1068	27.6712	0.0761	0.0361	7.8342
20	0.4564	13.5903	111.5647	2.1911	29.7781	0.0736	0.0336	8.2091
21	0.4388	14.0292	120.3414	2.2788	31.9692	0.0713	0.0313	8.5779
22	0.4220	14.4511	129.2024	2.3699	34.2480	0.0692	0.0292	8.9407
23	0.4057	14.8568	138.1284	2.4647	36.6179	0.0673	0.0273	9.2973
24	0.3901	15.2470	147.1012	2.5633	39.0826	0.0656	0.0256	9.6479
25	0.3751	15.6221	156.1040	2.6658	41.6459	0.0640	0.0240	9.9925
30	0.3083	17.2920	201.0618	3.2434	56.0849	0.0578	0.0178	11.6274
40	0.2083	19.7928	286.5303	4.8010	95.0255	0.0505	0.0105	14.4765
50	0.1407	21.4822	361.1638	7.1067	152.6671	0.0466	0.0066	16.8122
60	0.0951	22.6235	422.9966	10.5196	237.9907	0.0442	0.0042	18.6972
100	0.0198	24.5050	563.1249	50.5049	1,237.6237	0.0408	0.0008	22.9800

Factor Table - $i = 6.00\%$

n	P/F	P/A	P/G	F/P	F/A	A/P	A/F	A/G
1	0.9434	0.9434	0.0000	1.0600	1.0000	1.0600	1.0000	0.0000
2	0.8900	1.8334	0.8900	1.1236	2.0600	0.5454	0.4854	0.4854
3	0.8396	2.6730	2.5692	1.1910	3.1836	0.3741	0.3141	0.9612
4	0.7921	3.4651	4.9455	1.2625	4.3746	0.2886	0.2286	1.4272
5	0.7473	4.2124	7.9345	1.3382	5.6371	0.2374	0.1774	1.8836
6	0.7050	4.9173	11.4594	1.4185	6.9753	0.2034	0.1434	2.3304
7	0.6651	5.5824	15.4497	1.5036	8.3938	0.1791	0.1191	2.7676
8	0.6274	6.2098	19.8416	1.5938	9.8975	0.1610	0.1010	3.1952
9	0.5919	6.8017	24.5768	1.6895	11.4913	0.1470	0.0870	3.6133
10	0.5584	7.3601	29.6023	1.7908	13.1808	0.1359	0.0759	4.0220
11	0.5268	7.8869	34.8702	1.8983	14.9716	0.1268	0.0668	4.4213
12	0.4970	8.3838	40.3369	2.0122	16.8699	0.1193	0.0593	4.8113
13	0.4688	8.8527	45.9629	2.1329	18.8821	0.1130	0.0530	5.1920
14	0.4423	9.2950	51.7128	2.2609	21.0151	0.1076	0.0476	5.5635
15	0.4173	9.7122	57.5546	2.3966	23.2760	0.1030	0.0430	5.9260
16	0.3936	10.1059	63.4592	2.5404	25.6725	0.0990	0.0390	6.2794
17	0.3714	10.4773	69.4011	2.6928	28.2129	0.0954	0.0354	6.6240
18	0.3505	10.8276	75.3569	2.8543	30.9057	0.0924	0.0324	6.9597
19	0.3305	11.1581	81.3062	3.0256	33.7600	0.0896	0.0296	7.2867
20	0.3118	11.4699	87.2304	3.2071	36.7856	0.0872	0.0272	7.6051
21	0.2942	11.7641	93.1136	3.3996	39.9927	0.0850	0.0250	7.9151
22	0.2775	12.0416	98.9412	3.6035	43.3923	0.0830	0.0230	8.2166
23	0.2618	12.3034	104.7007	3.8197	46.9958	0.0813	0.0213	8.5099
24	0.2470	12.5504	110.3812	4.0489	50.8156	0.0797	0.0197	8.7951
25	0.2330	12.7834	115.9732	4.2919	54.8645	0.0782	0.0182	9.0722
30	0.1741	13.7648	142.3588	5.7435	79.0582	0.0726	0.0126	10.3422
40	0.0972	15.0463	185.9568	10.2857	154.7620	0.0665	0.0065	12.3590
50	0.0543	15.7619	217.4574	18.4202	290.3359	0.0634	0.0034	13.7964
60	0.0303	16.1614	239.0428	32.9877	533.1282	0.0619	0.0019	14.7909
100	0.0029	16.6175	272.0471	339.3021	5,638.3681	0.0602	0.0002	16.3711

Interest Rate Tables
Factor Table - $i = 8.00\%$

n	P/F	P/A	P/G	F/P	F/A	A/P	A/F	A/G
1	0.9259	0.9259	0.0000	1.0800	1.0000	1.0800	1.0000	0.0000
2	0.8573	1.7833	0.8573	1.1664	2.0800	0.5608	0.4808	0.4808
3	0.7938	2.5771	2.4450	1.2597	3.2464	0.3880	0.3080	0.9487
4	0.7350	3.3121	4.6501	1.3605	4.5061	0.3019	0.2219	1.4040
5	0.6806	3.9927	7.3724	1.4693	5.8666	0.2505	0.1705	1.8465
6	0.6302	4.6229	10.5233	1.5869	7.3359	0.2163	0.1363	2.2763
7	0.5835	5.2064	14.0242	1.7138	8.9228	0.1921	0.1121	2.6937
8	0.5403	5.7466	17.8061	1.8509	10.6366	0.1740	0.0940	3.0985
9	0.5002	6.2469	21.8081	1.9990	12.4876	0.1601	0.0801	3.4910
10	0.4632	6.7101	25.9768	2.1589	14.4866	0.1490	0.0690	3.8713
11	0.4289	7.1390	30.2657	2.3316	16.6455	0.1401	0.0616	4.2395
12	0.3971	7.5361	34.6339	2.5182	18.9771	0.1327	0.0527	4.5957
13	0.3677	7.9038	39.0463	2.7196	21.4953	0.1265	0.0465	4.9402
14	0.3405	8.2442	43.4723	2.9372	24.2149	0.1213	0.0413	5.2731
15	0.3152	8.5595	47.8857	3.1722	27.1521	0.1168	0.0368	5.5945
16	0.2919	8.8514	52.2640	3.4259	30.3243	0.1130	0.0330	5.9046
17	0.2703	9.1216	56.5883	3.7000	33.7502	0.1096	0.0296	6.2037
18	0.2502	9.3719	60.8426	3.9960	37.4502	0.1067	0.0267	6.4920
19	0.2317	9.6036	65.0134	4.3157	41.4463	0.1041	0.0241	6.7697
20	0.2145	9.8181	69.0898	4.6610	45.7620	0.1019	0.0219	7.0369
21	0.1987	10.0168	73.0629	5.0338	50.4229	0.0998	0.0198	7.2940
22	0.1839	10.2007	76.9257	5.4365	55.4568	0.0980	0.0180	7.5412
23	0.1703	10.3711	80.6726	5.8715	60.8933	0.0964	0.0164	7.7786
24	0.1577	10.5288	84.2997	6.3412	66.7648	0.0950	0.0150	8.0066
25	0.1460	10.6748	87.8041	6.8485	73.1059	0.0937	0.0137	8.2254
30	0.0994	11.2578	103.4558	10.0627	113.2832	0.0888	0.0088	9.1897
40	0.0460	11.9246	126.0422	21.7245	259.0565	0.0839	0.0039	10.5699
50	0.0213	12.2335	139.5928	46.9016	573.7702	0.0817	0.0017	11.4107
60	0.0099	12.3766	147.3000	101.2571	1,253.2133	0.0808	0.0008	11.9015
100	0.0005	12.4943	155.6107	2,199.7613	27,484.5157	0.0800		12.4545

Factor Table - $i = 10.00\%$

n	P/F	P/A	P/G	F/P	F/A	A/P	A/F	A/G
1	0.9091	0.9091	0.0000	1.1000	1.0000	1.1000	1.0000	0.0000
2	0.8264	1.7355	0.8264	1.2100	2.1000	0.5762	0.4762	0.4762
3	0.7513	2.4869	2.3291	1.3310	3.3100	0.4021	0.3021	0.9366
4	0.6830	3.1699	4.3781	1.4641	4.6410	0.3155	0.2155	1.3812
5	0.6209	3.7908	6.8618	1.6105	6.1051	0.2638	0.1638	1.8101
6	0.5645	4.3553	9.6842	1.7716	7.7156	0.2296	0.1296	2.2236
7	0.5132	4.8684	12.7631	1.9487	9.4872	0.2054	0.1054	2.6216
8	0.4665	5.3349	16.0287	2.1436	11.4359	0.1874	0.0874	3.0045
9	0.4241	5.7590	19.4215	2.3579	13.5735	0.1736	0.0736	3.3724
10	0.3855	6.1446	22.8913	2.5937	15.9374	0.1627	0.0627	3.7255
11	0.3505	6.4951	26.3962	2.8531	18.5312	0.1540	0.0540	4.0641
12	0.3186	6.8137	29.9012	3.1384	21.3843	0.1468	0.0468	4.3884
13	0.2897	7.1034	33.3772	3.4523	24.5227	0.1408	0.0408	4.6988
14	0.2633	7.3667	36.8005	3.7975	27.9750	0.1357	0.0357	4.9955
15	0.2394	7.6061	40.1520	4.1772	31.7725	0.1315	0.0315	5.2789
16	0.2176	7.8237	43.4164	4.5950	35.9497	0.1278	0.0278	5.5493
17	0.1978	8.0216	46.5819	5.0545	40.5447	0.1247	0.0247	5.8071
18	0.1799	8.2014	49.6395	5.5599	45.5992	0.1219	0.0219	6.0526
19	0.1635	8.3649	52.5827	6.1159	51.1591	0.1195	0.0195	6.2861
20	0.1486	8.5136	55.4069	6.7275	57.2750	0.1175	0.0175	6.5081
21	0.1351	8.6487	58.1095	7.4002	64.0025	0.1156	0.0156	6.7189
22	0.1228	8.7715	60.6893	8.1403	71.4027	0.1140	0.0140	6.9189
23	0.1117	8.8832	63.1462	8.9543	79.5430	0.1126	0.0126	7.1085
24	0.1015	8.9847	65.4813	9.8497	88.4973	0.1113	0.0113	7.2881
25	0.0923	9.0770	67.6964	10.8347	98.3471	0.1102	0.0102	7.4580
30	0.0573	9.4269	77.0766	17.4494	164.4940	0.1061	0.0061	8.1762
40	0.0221	9.7791	88.9525	45.2593	442.5926	0.1023	0.0023	9.0962
50	0.0085	9.9148	94.8889	117.3909	1,163.9085	0.1009	0.0009	9.5704
60	0.0033	9.9672	97.7010	304.4816	3,034.8164	0.1003	0.0003	9.8023
100	0.0001	9.9993	99.9202	13,780.6123	137,796.1234	0.1000		9.9927

Interest Rate Tables
Factor Table - $i = 12.00\%$

n	P/F	P/A	P/G	F/P	F/A	A/P	A/F	A/G
1	0.8929	0.8929	0.0000	1.1200	1.0000	1.1200	1.0000	0.0000
2	0.7972	1.6901	0.7972	1.2544	2.1200	0.5917	0.4717	0.4717
3	0.7118	2.4018	2.2208	1.4049	3.3744	0.4163	0.2963	0.9246
4	0.6355	3.0373	4.1273	1.5735	4.7793	0.3292	0.2092	1.3589
5	0.5674	3.6048	6.3970	1.7623	6.3528	0.2774	0.1574	1.7746
6	0.5066	4.1114	8.9302	1.9738	8.1152	0.2432	0.1232	2.1720
7	0.4523	4.5638	11.6443	2.2107	10.0890	0.2191	0.0991	2.5515
8	0.4039	4.9676	14.4714	2.4760	12.2997	0.2013	0.0813	2.9131
9	0.3606	5.3282	17.3563	2.7731	14.7757	0.1877	0.0677	3.2574
10	0.3220	5.6502	20.2541	3.1058	17.5487	0.1770	0.0570	3.5847
11	0.2875	5.9377	23.1288	3.4785	20.6546	0.1684	0.0484	3.8953
12	0.2567	6.1944	25.9523	3.8960	24.1331	0.1614	0.0414	4.1897
13	0.2292	6.4235	28.7024	4.3635	28.0291	0.1557	0.0357	4.4683
14	0.2046	6.6282	31.3624	4.8871	32.3926	0.1509	0.0309	4.7317
15	0.1827	6.8109	33.9202	5.4736	37.2797	0.1468	0.0268	4.9803
16	0.1631	6.9740	36.3670	6.1304	42.7533	0.1434	0.0234	5.2147
17	0.1456	7.1196	38.6973	6.8660	48.8837	0.1405	0.0205	5.4353
18	0.1300	7.2497	40.9080	7.6900	55.7497	0.1379	0.0179	5.6427
19	0.1161	7.3658	42.9979	8.6128	63.4397	0.1358	0.0158	5.8375
20	0.1037	7.4694	44.9676	9.6463	72.0524	0.1339	0.0139	6.0202
21	0.0926	7.5620	46.8188	10.8038	81.6987	0.1322	0.0122	6.1913
22	0.0826	7.6446	48.5543	12.1003	92.5026	0.1308	0.0108	6.3514
23	0.0738	7.7184	50.1776	13.5523	104.6029	0.1296	0.0096	6.5010
24	0.0659	7.7843	51.6929	15.1786	118.1552	0.1285	0.0085	6.6406
25	0.0588	7.8431	53.1046	17.0001	133.3339	0.1275	0.0075	6.7708
30	0.0334	8.0552	58.7821	29.9599	241.3327	0.1241	0.0041	7.2974
40	0.0107	8.2438	65.1159	93.0510	767.0914	0.1213	0.0013	7.8988
50	0.0035	8.3045	67.7624	289.0022	2,400.0182	0.1204	0.0004	8.1597
60	0.0011	8.3240	68.8100	897.5969	7,471.6411	0.1201	0.0001	8.2664
100		8.3332	69.4336	83,522.2657	696,010.5477	0.1200		8.3321

Factor Table - $i = 18.00\%$

n	P/F	P/A	P/G	F/P	F/A	A/P	A/F	A/G
1	0.8475	0.8475	0.0000	1.1800	1.0000	1.1800	1.0000	0.0000
2	0.7182	1.5656	0.7182	1.3924	2.1800	0.6387	0.4587	0.4587
3	0.6086	2.1743	1.9354	1.6430	3.5724	0.4599	0.2799	0.8902
4	0.5158	2.6901	3.4828	1.9388	5.2154	0.3717	0.1917	1.2947
5	0.4371	3.1272	5.2312	2.2878	7.1542	0.3198	0.1398	1.6728
6	0.3704	3.4976	7.0834	2.6996	9.4423	0.2859	0.1059	2.0252
7	0.3139	3.8115	8.9670	3.1855	12.1415	0.2624	0.0824	2.3526
8	0.2660	4.0776	10.8292	3.7589	15.3270	0.2452	0.0652	2.6558
9	0.2255	4.3030	12.6329	4.4355	19.0859	0.2324	0.0524	2.9358
10	0.1911	4.4941	14.3525	5.2338	23.5213	0.2225	0.0425	3.1936
11	0.1619	4.6560	15.9716	6.1759	28.7551	0.2148	0.0348	3.4303
12	0.1372	4.7932	17.4811	7.2876	34.9311	0.2086	0.0286	3.6470
13	0.1163	4.9095	18.8765	8.5994	42.2187	0.2037	0.0237	3.8449
14	0.0985	5.0081	20.1576	10.1472	50.8180	0.1997	0.0197	4.0250
15	0.0835	5.0916	21.3269	11.9737	60.9653	0.1964	0.0164	4.1887
16	0.0708	5.1624	22.3885	14.1290	72.9390	0.1937	0.0137	4.3369
17	0.0600	5.2223	23.3482	16.6722	87.0680	0.1915	0.0115	4.4708
18	0.0508	5.2732	24.2123	19.6731	103.7403	0.1896	0.0096	4.5916
19	0.0431	5.3162	24.9877	23.2144	123.4135	0.1881	0.0081	4.7003
20	0.0365	5.3527	25.6813	27.3930	146.6280	0.1868	0.0068	4.7978
21	0.0309	5.3837	26.3000	32.3238	174.0210	0.1857	0.0057	4.8851
22	0.0262	5.4099	26.8506	38.1421	206.3448	0.1848	0.0048	4.9632
23	0.0222	5.4321	27.3394	45.0076	244.4868	0.1841	0.0041	5.0329
24	0.0188	5.4509	27.7725	53.1090	289.4944	0.1835	0.0035	5.0950
25	0.0159	5.4669	28.1555	62.6686	342.6035	0.1829	0.0029	5.1502
30	0.0070	5.5168	29.4864	143.3706	790.9480	0.1813	0.0013	5.3448
40	0.0013	5.5482	30.5269	750.3783	4,163.2130	0.1802	0.0002	5.5022
50	0.0003	5.5541	30.7856	3,927.3569	21,813.0937	0.1800		5.5428
60	0.0001	5.5553	30.8465	20,555.1400	114,189.6665	0.1800		5.5526
100		5.5556	30.8642	15,424,131.91	85,689,616.17	0.1800		5.5555

Chemical Engineering

Chemical Reaction Engineering

Nomenclature

A chemical reaction may be expressed by the general equation

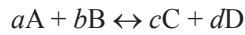

The rate of reaction of any component is defined as the moles of that component formed per unit time per unit volume.

$$-r_A = -\frac{1}{V} \frac{dN_A}{dt} \quad (\text{negative because A disappears})$$

$$-r_A = \frac{-dC_A}{dt} \quad \text{if } V \text{ is constant}$$

The rate of reaction is frequently expressed by

$$-r_A = kf_r(C_A, C_B, \dots)$$

where

k = reaction rate constant

C_I = concentration of component I

In the conversion of A, the fractional conversion X_A is defined as the moles of A reacted per mole of A fed.

$$X_A = (C_{A0} - C_A)/C_{A0} \quad \text{if } V \text{ is constant}$$

The Arrhenius equation gives the dependence of k on temperature

$$k = Ae^{-E_a/RT}$$

where

A = pre-exponential or frequency factor

E_a = activation energy (J/mol, cal/mol)

T = temperature (K)

\bar{R} = gas law constant = 8.314 J/(mol•K)

For values of rate constant (k_i) at two temperatures (T_i),

$$E_a = \frac{RT_1T_2}{(T_1 - T_2)} \ln\left(\frac{k_1}{k_2}\right)$$

Reaction Order

$$\text{If } -r_A = kC_A^x C_B^y$$

the reaction is x order with respect to reactant A and y order with respect to reactant B. The overall order is

$$n = x + y$$

Batch Reactor, Constant Volume

For a well-mixed, constant-volume batch reactor

$$-r_A = -dC_A/dt$$

$$t = C_{A0} \int_0^{X_A} dX_A / (-r_A)$$

Zero-Order Irreversible Reaction

$$\begin{aligned}
 -r_A &= kC_A^0 = k(1) \\
 -dC_A/dt &= k && \text{or} \\
 C_A &= C_{A0} - kt \\
 dX_A/dt &= k/C_{A0} && \text{or} \\
 C_{A0}X_A &= kt
 \end{aligned}$$

First-Order Irreversible Reaction

$$\begin{aligned}
 -r_A &= kC_A \\
 -dC_A/dt &= kC_A && \text{or} \\
 \ln(C_A/C_{A0}) &= -kt \\
 dX_A/dt &= k(1 - X_A) && \text{or} \\
 \ln(1 - X_A) &= -kt
 \end{aligned}$$

Second-Order Irreversible Reaction

$$\begin{aligned}
 -r_A &= kC_A^2 \\
 -dC_A/dt &= kC_A^2 && \text{or} \\
 1/C_A - 1/C_{A0} &= kt \\
 dX_A/dt &= kC_{A0}(1 - X_A)^2 && \text{or} \\
 X_A[C_{A0}(1 - X_A)] &= kt
 \end{aligned}$$

First-Order Reversible Reactions

$$\begin{aligned}
 A &\underset{k_2}{\overset{k_1}{\rightleftharpoons}} R \\
 -r_A &= -\frac{dC_A}{dt} = k_1 C_A - k_2 C_R \\
 K_c &= k_1/k_2 = \hat{C}_R/\hat{C}_A \\
 M &= C_{R0}/C_{A0} \\
 \frac{dX_A}{dt} &= \frac{k_1(M+1)}{M+\hat{X}_A}(\hat{X}_A - X_A) \\
 -\ln\left(1 - \frac{X_A}{\hat{X}_A}\right) &= -\ln\frac{C_A - \hat{C}_A}{C_{A0} - \hat{C}_A} \\
 &= \frac{(M+1)}{(M+\hat{X}_A)}k_1 t \\
 \hat{X}_A &\text{ is the equilibrium conversion.}
 \end{aligned}$$

Reactions of Shifting Order

$$-r_A = \frac{k_1 C_A}{1 + k_2 C_A}$$

$$\ln\left(\frac{C_{A_0}}{C_A}\right) + k_2(C_{A_0} - C_A) = k_1 t$$

$$\frac{\ln(C_{A_0}/C_A)}{C_{A_0} - C_A} = -k_2 + \frac{k_1 t}{C_{A_0} - C_A}$$

This form of the rate equation is used for elementary enzyme-catalyzed reactions and for elementary surfaced-catalyzed reactions.

Elementary enzyme-catalyzed reactions

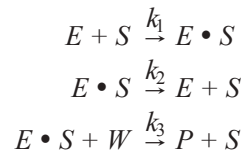

where E , S , W , P are the enzyme, substrate, water, product (P can be multiple products) are often described by the Michaelis-Menten equation:

$$-r_s = \frac{V_{\max} C_s}{K_m + C_s}$$

where

V_{\max} = maximum rate of reaction for a given enzyme concentration = $k_3 C_w C_{E_t}$ (moles/volume time)

K_m = Michaelis constant (moles/volume)

$C_{E_t} = C_E + C_{ES}$

For batch reactor calculations, the time to reach a given conversion

$$t = \frac{K_m}{V_{\max}} \ln \frac{1}{1-x} + \frac{C_{s0} x}{V_{\max}}$$

Batch Reactor, Variable Volume

If the volume of the reacting mass varies with the conversion (such as a variable-volume batch reactor) according to

$$V = V_{X_A=0} (1 + \varepsilon_A X_A)$$

(i.e., at constant pressure)

where

$$\varepsilon_A = \frac{V_{X_A=1} - V_{X_A=0}}{V_{X_A=0}} = \frac{\Delta V}{V_{X_A=0}}$$

then at any time

$$C_A = C_{A0} \left[\frac{1 - X_A}{1 + \varepsilon_A X_A} \right]$$

and

$$t = -C_{A0} \int_0^{X_A} dX_A / [(1 + \varepsilon_A X_A)(-r_A)]$$

For a first-order irreversible reaction,

$$kt = -\ln(1 - X_A) = -\ln\left(1 - \frac{\Delta V}{\varepsilon_A V_{X_A=0}}\right)$$

Flow Reactors, Steady State

Space-time τ is defined as the reactor volume divided by the inlet volumetric feed rate. Space-velocity SV is the reciprocal of space-time, $SV = 1/\tau$.

Plug-Flow Reactor (PFR)

$$\tau = \frac{C_{A0}V_{PFR}}{F_{A0}} = C_{A0} \int_0^{X_A} \frac{dX_A}{(-r_A)}$$

where F_{A0} = moles of A fed per unit time

Continuous-Stirred Tank Reactor (CSTR)

For a constant-volume, well-mixed CSTR

$$\frac{\tau}{C_{A0}} = \frac{V_{CSTR}}{F_{A0}} = \frac{X_A}{-r_A}$$

where $-r_A$ is evaluated at exit stream conditions.

Continuous-Stirred Tank Reactors in Series

With a first-order reaction $A \rightarrow R$, no change in volume.

$$\begin{aligned} \tau_{N\text{-reactors}} &= N\tau_{\text{individual}} \\ &= \frac{N}{k} \left[\left(\frac{C_{A0}}{C_{AN}} \right)^{1/N} - 1 \right] \end{aligned}$$

where

N = number of CSTRs (equal volume) in series

C_{AN} = concentration of A leaving the N th CSTR

Two Irreversible Reactions in Parallel

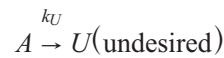
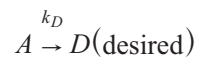

$$-r_A = -dc_A/dt = k_D C_A^x + k_U C_A^y$$

$$r_D = dc_D/dt = k_D C_A^x$$

$$r_U = dc_U/dt = k_U C_A^y$$

Y_D = instantaneous fractional yield of D

$$= dC_D/(-dC_A)$$

\bar{Y}_D = overall fractional yield of D

$$= N_{Df}/(N_{A0} - N_{Af})$$

where N_{Af} and N_{Df} are measured at the outlet of the flow reactor.

S_{DU} = overall selectivity to D

$$= N_{Df}/N_{Uf}$$

Two First-Order Irreversible Reactions in Series

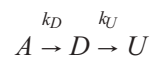

$$r_A = -dc_A/dt = k_D C_A$$

$$r_D = dc_D/dt = k_D C_A - k_U C_D$$

$$r_U = dc_U/dt = k_U C_D$$

Yield and selectivity definitions are identical to those for two irreversible reactions in parallel. The optimal yield of D in a PFR is

$$\frac{C_{D,\max}}{C_{A_0}} = \left(\frac{k_D}{k_U}\right)^{k_U/(k_U - k_D)}$$

at time

$$\tau_{\max} = \frac{1}{k_{\log \text{ mean}}} = \frac{\ln(k_U/k_D)}{(k_U - k_D)}$$

The optimal yield of D in a CSTR is

$$\frac{C_{D,\max}}{C_{A_0}} = \frac{1}{\left[(k_U/k_D)^{1/2} + 1\right]^2}$$

at time

$$\tau_{\max} = 1/\sqrt{k_D k_U}$$

Mass Transfer

Diffusion

Molecular Diffusion

$$\text{Gas: } N_A = \frac{p_A}{P}(N_A + N_B) - \frac{D_m}{RT} \frac{\partial p_A}{\partial z}$$

$$\text{Liquid: } N_A = x_A(N_A + N_B) - CD_m \frac{\partial x_A}{\partial z}$$

where

N_i = molar flux of component i

P = pressure

p_i = partial pressure of component i

D_m = mass diffusivity

\bar{R} = universal gas constant

T = temperature

z = length

Unidirectional Diffusion of a Gas A Through a Second Stagnant Gas B ($N_b=0$)

$$N_A = \frac{D_m P}{RT(p_B)_{lm}} \times \frac{(p_{A2} - p_{A1})}{z_2 - z_1}$$

in which $(p_B)_{lm}$ is the log mean of p_{B2} and p_{B1}

$$(p_{BM})_{lm} = \frac{p_{B2} - p_{B1}}{\ln\left(\frac{p_{B2}}{p_{B1}}\right)}$$

where

N_i = diffusive flux [mole/(time × area)] of component i through area A , in z direction

D_m = mass diffusivity

p_I = partial pressure of species I

C = concentration (mole/volume)

$(z_2 - z_1)$ = diffusion flow path length

Equimolar Counter-Diffusion (Gases)

$$(N_B = -N_A)$$

$$N_A = D_m / (RT) \times [(p_{A1} - p_{A2}) / (\Delta z)]$$

$$N_A = D_m (C_{A1} - C_{A2}) / \Delta z$$

Convection

Two-Film Theory (for Equimolar Counter-Diffusion)

$$\begin{aligned} N_A &= k'_G (p_{AG} - p_{Ai}) \\ &= k'_L (C_{Ai} - C_{AL}) \\ &= K'_G (p_{AG} - p_A^*) \\ &= K'_L (C_A^* - C_{AL}) \end{aligned}$$

where

N_A = molar flux of component A

k'_G = gas phase mass-transfer coefficient

k'_L = liquid phase mass-transfer coefficient

K'_G = overall gas phase mass-transfer coefficient

K'_L = overall liquid phase mass-transfer coefficient

p_{AG} = partial pressure in component A in the bulk gas phase

p_{Ai} = partial pressure at component A at the gas-liquid interface

C_{Ai} = concentration (mole/volume) of component A in the liquid phase at the gas-liquid interface

C_{AL} = concentration of component A in the bulk liquid phase

p_A^* = partial pressure of component A in equilibrium with C_{AL}

C_A^* = concentration of component A in equilibrium with the bulk gas vapor composition of A

Overall Coefficients

$$1/K'_G = 1/k'_G + H/k'_L$$

$$1/K'_L = 1/Hk'_G + 1/k'_L$$

H = Henry's Law constant where $p_A^* = H C_{AL}$ and $C_A^* = p_{AG}/H$

Dimensionless Group Equation (Sherwood)

For the turbulent flow inside a tube the Sherwood number

$$Sh = \left(\frac{k_m D}{D_m} \right) = 0.023 \left(\frac{DV\rho}{\mu} \right)^{0.8} \left(\frac{\mu}{\rho D_m} \right)^{1/3}$$

where

D = inside diameter

D_m = diffusion coefficient

V = average velocity in the tube

ρ = fluid density

μ = fluid viscosity

k_m = mass-transfer coefficient

Distillation

Definitions:

- α = relative volatility
- B = molar bottoms-product rate
- D = molar overhead-product rate
- F = molar feed rate
- L = molar liquid downflow rate
- R_D = ratio of reflux to overhead product
- V = molar vapor upflow rate
- W = total moles in still pot
- x = mole fraction of the more volatile component in the liquid phase
- y = mole fraction of the more volatile component in the vapor phase

Subscripts:

- B = bottoms product
- D = overhead product
- F = feed
- m = any plate in stripping section of column
- $m+1$ = plate below plate m
- n = any plate in rectifying section of column
- $n+1$ = plate below plate n
- o = original charge in still pot

Flash (or equilibrium) Distillation

Component material balance:

$$Fz_F = yV + xL$$

Overall material balance:

$$F = V + L$$

Differential (Simple or Rayleigh) Distillation

$$\ln\left(\frac{W}{W_o}\right) = \int_{x_o}^x \frac{dx}{y-x}$$

When the relative volatility α is constant,

$$y = \alpha x / [1 + (\alpha - 1)x]$$

can be substituted to give

$$\ln\left(\frac{W}{W_o}\right) = \frac{1}{(\alpha - 1)} \ln\left[\frac{x(1 - x_o)}{x_o(1 - x)}\right] + \ln\left[\frac{1 - x_o}{1 - x}\right]$$

For binary system following Raoult's Law

$$\alpha = (y/x)_a / (y/x)_b = p_a / p_b$$

where

p_i = partial pressure of component i .

Continuous Distillation (Binary System)

Constant molal overflow is assumed.

Equilibrium stages numbered from top.

Overall Material Balances

Total Material:

$$F = D + B$$

Component A:

$$Fx_F = Dx_D + Bx_B$$

Operating Lines

Rectifying section

Total Material:

$$V_{n+1} = L_n + D$$

Component A:

$$V_{n+1}y_{n+1} = L_nx_n + Dx_D$$

$$y_{n+1} = [L_n/(L_n + D)]x_n + Dx_D/(L_n + D)$$

Stripping section

Total Material:

$$L_m = V_{m+1} + B$$

Component A:

$$L_mx_m = V_{m+1}y_{m+1} + Bx_B$$

$$y_{m+1} = [L_m/(L_m - B)]x_m - Bx_B/(L_m - B)$$

Reflux ratio

Ratio of reflux to overhead product

$$R_D = L_R/D = (V_R - D)/D$$

Minimum reflux ratio is defined as that value which results in an infinite number of contact stages.

For a binary system, the equation of the operating line is

$$y = \frac{R_D}{R_D + 1}x + \frac{x_D}{R_D + 1}$$

Feed condition line

$$\text{slope} = q/(q - 1)$$

where

$$q = \frac{\text{heat to convert one mol of feed to saturated vapor}}{\text{molar heat of vaporization}}$$

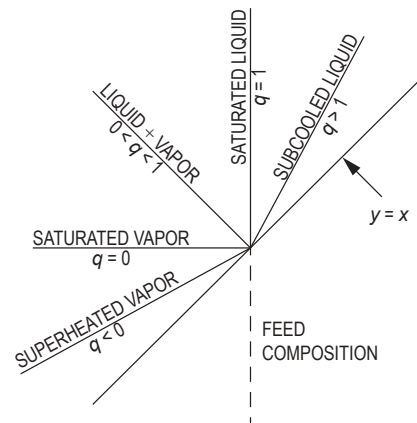

q-LINE SLOPES

Murphree plate efficiency

$$E_{ME} = (y_n - y_{n+1}) / (y_n^* - y_{n+1})$$

where

y_n = concentration of vapor above equilibrium stage n

y_{n+1} = concentration of vapor entering from equilibrium stage below n

y_n^* = concentration of vapor in equilibrium with liquid leaving equilibrium stage n

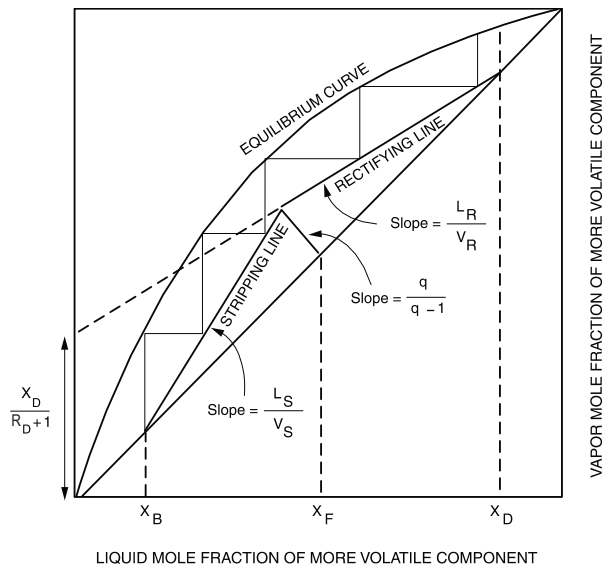
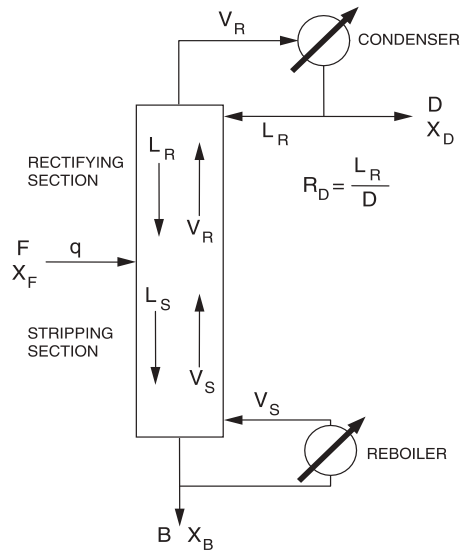

Vapor-Liquid Equilibrium (VLE) Diagram

Absorption (Packed Columns)

Continuous Contact Columns

$$Z = NTU_G \cdot HTU_G = NTU_L \cdot HTU_L = N_{EQ} \cdot HETP$$

where

Z = column height

NTU_G = number of transfer units (gas phase)

NTU_L = number of transfer units (liquid phase)

N_{EQ} = number of equilibrium stages

HTU_G = height of transfer unit (gas phase)

HTU_L = height of transfer unit (liquid phase)

$HETP$ = height equivalent to theoretical plate (stage)

$$HTU_G = \frac{G}{K'_G a} \quad HTU_L = \frac{L}{K'_L a}$$

where

G = gas phase mass velocity (mass or moles/flow area • time)

L = liquid phase mass velocity (mass or moles/flow area • time)

K'_G = overall gas phase mass-transfer coefficient (mass or moles/mass-transfer area • time)

K'_L = overall liquid phase mass-transfer coefficient (mass or moles/mass-transfer area • time)

a = mass-transfer area/volume of column (length⁻¹)

$$NTU_G = \int_{y_1}^{y_2} \frac{dy}{(y - y^*)} \quad NTU_L = \int_{x_1}^{x_2} \frac{dx}{(x^* - x)}$$

where

y = gas phase solute mole fraction

x = liquid phase solute mole fraction

y^* = $K \cdot x$

where

K = equilibrium constant

x^* = y/K

where

K = equilibrium constant

y_2, x_2 = mole fractions at the lean end of column

y_1, x_1 = mole fractions at the rich end of column

For dilute solutions (constant G/L and constant K value for entire column):

$$NTU_G = \frac{y_1 - y_2}{(y - y^*)_{LM}}$$

$$(y - y^*)_{LM} = \frac{(y_1 - y_1^*) - (y_2 - y_2^*)}{\ln \left(\frac{y_1 - y_1^*}{y_2 - y_2^*} \right)}$$

For a chemically reacting system—absorbed solute reacts in the liquid phase—the preceding relation simplifies to:

$$NTU_G = \ln \left(\frac{y_1}{y_2} \right)$$

Transport Phenomena-Momentum, Heat, and Mass-Transfer Analogy

For the equations which apply to *turbulent flow in circular tubes*, the following definitions apply:

$$\text{Nu} = \text{Nusselt Number} = \frac{hD}{k}$$

$$\text{Pr} = \text{Prandtl Number} = \frac{c_p \mu}{k}$$

$$\text{Re} = \text{Reynolds Number} = \frac{DV\rho}{\mu}$$

$$\text{Sc} = \text{Schmidt Number} = \frac{\mu}{\rho D_m}$$

$$\text{Sh} = \text{Sherwood Number} = \frac{k_m D}{D_m}$$

$$\text{St} = \text{Stanton Number} = \frac{h}{c_p G}$$

$$c_m = \text{concentration (mol/m}^3\text{)}$$

$$c_p = \text{heat capacity of fluid [J/(kg}\cdot\text{K)]}$$

$$D = \text{tube inside diameter (m)}$$

$$D_m = \text{diffusion coefficient (m}^2\text{/s)}$$

$$(dc_m/dy)_w = \text{concentration gradient at the wall (mol/m}^4\text{)}$$

$$(dT/dy)_w = \text{temperature gradient at the wall (K/m)}$$

$$(dv/dy)_w = \text{velocity gradient at the wall (s}^{-1}\text{)}$$

$$f = \text{Moody, Darcy, or Stanton friction factor}$$

$$G = \text{mass velocity [kg/(m}^2\cdot\text{s)]}$$

$$h = \text{heat-transfer coefficient at the wall [W/(m}^2\cdot\text{K)]}$$

$$k = \text{thermal conductivity of fluid [W/(m}\cdot\text{K)]}$$

$$k_m = \text{mass-transfer coefficient (m/s)}$$

$$L = \text{length over which pressure drop occurs (m)}$$

$$(N/A)_w = \text{inward mass-transfer flux at the wall [mol/(m}^2\cdot\text{s)]}$$

$$(\dot{Q}/A)_w = \text{inward heat-transfer flux at the wall (W/m}^2\text{)}$$

$$y = \text{distance measured from inner wall toward centerline (m)}$$

$$\Delta c_m = \text{concentration difference between wall and bulk fluid (mol/m}^3\text{)}$$

$$\Delta T = \text{temperature difference between wall and bulk fluid (K)}$$

$$\mu = \text{absolute dynamic viscosity (N}\cdot\text{s/m}^2\text{)}$$

$$\tau_w = \text{shear stress (momentum flux) at the tube wall (N/m}^2\text{)}$$

Definitions already introduced also apply.

Rate of Transfer as a Function of Gradients at the Wall

Momentum Transfer

$$\tau_w = -\mu \left(\frac{dv}{dy} \right)_w = -\frac{f \rho V^2}{8} = \left(\frac{D}{4} \right) \left(-\frac{\Delta p}{L} \right)_f$$

Heat Transfer

$$\left(\frac{\dot{Q}}{A} \right)_w = -k \left(\frac{dT}{dy} \right)_w$$

Mass Transfer in Dilute Solutions

$$\left(\frac{N}{A} \right)_w = -D_m \left(\frac{dc_m}{dy} \right)_w$$

Rate of Transfer in Terms of Coefficients

Momentum Transfer

$$\tau_w = \frac{f \rho V^2}{8}$$

Heat Transfer

$$\left(\frac{\dot{Q}}{A} \right)_w = h \Delta T$$

Mass Transfer

$$\left(\frac{N}{A} \right)_w = k_m \Delta c_m$$

Use of Friction Factor (f) to Predict Heat-Transfer and Mass-Transfer Coefficients (Turbulent Flow)

Heat Transfer

$$j_H = \left(\frac{\text{Nu}}{\text{RePr}} \right) \text{Pr}^{2/3} = \frac{f}{8}$$

Mass Transfer

$$j_M = \left(\frac{\text{Sh}}{\text{ReSc}} \right) \text{Sc}^{2/3} = \frac{f}{8}$$

Solids Handling

Particle Size Range Guide for the Application of Various Solid-Solid Operations

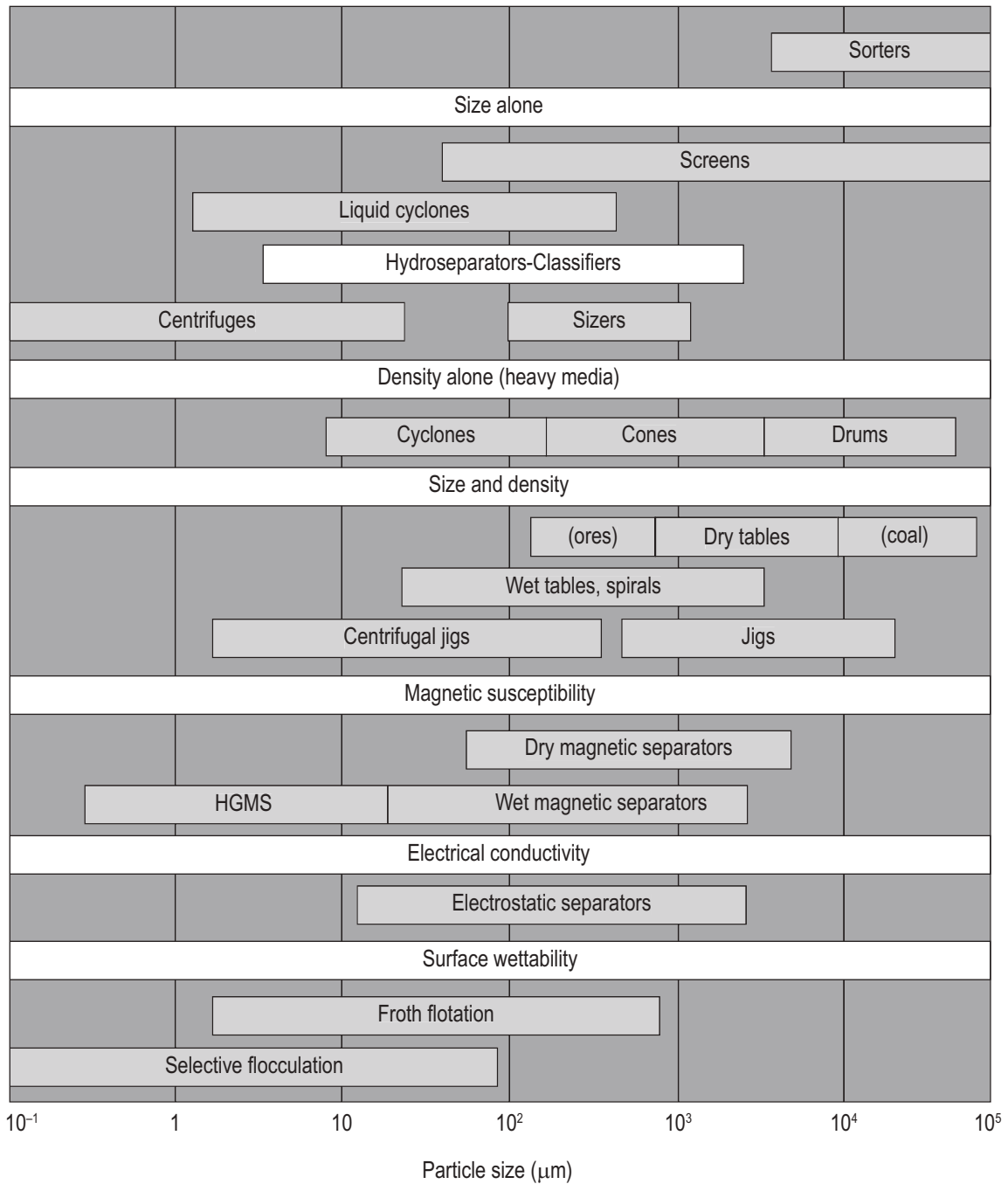

HGMS = High Gradient Magnetic Separation

Perry, Robert H., and Don Green, *Perry's Chemical Engineers' Handbook*, 7 ed, New York, McGraw-Hill, 1997, pp. 19-3, fig. 19.1.

Wet Solids: Equilibrium Moisture Curves at 25°C for Five Materials

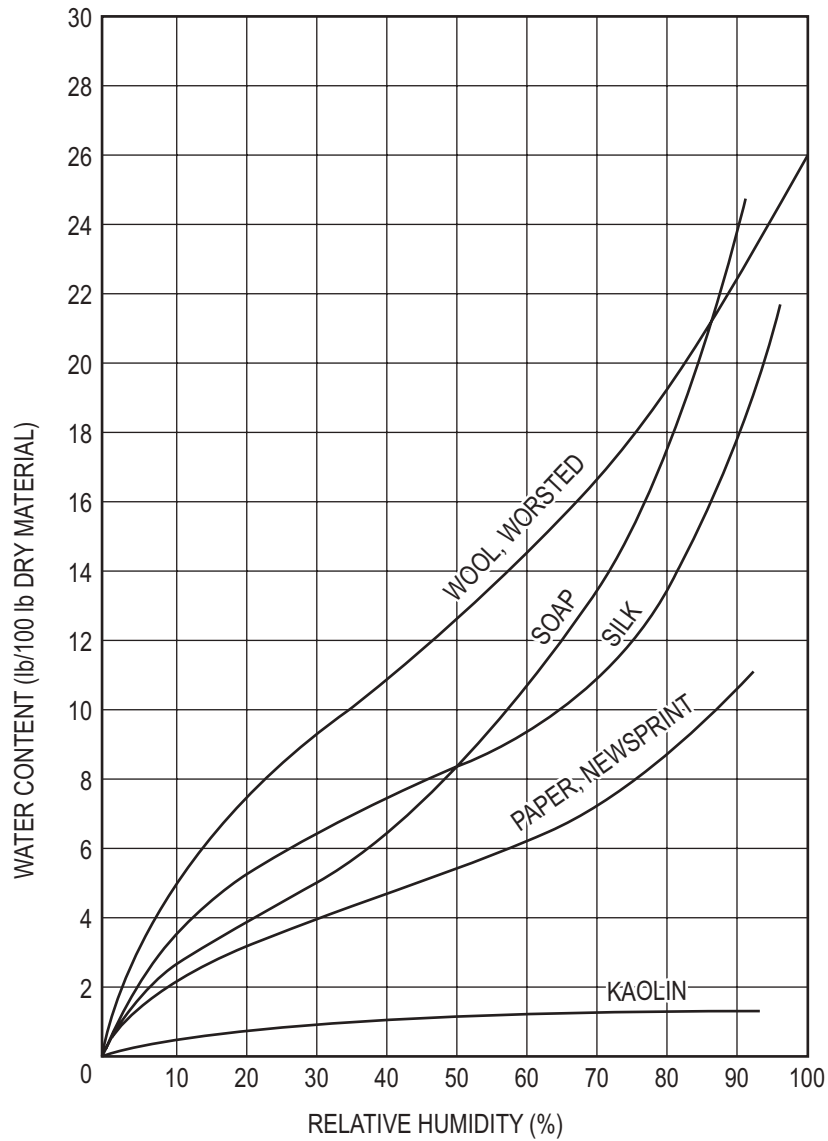

McCabe, Warren L.; Julian C. Smith; and Peter Harriott, *Unit Operations of Chemical Engineering*, 6 ed., New York: McGraw-Hill, 2001, p. 780.

Sieve Conversion Table

Mesh to Micron Conversion Table			INCHES	MILLIMETERS
			1 1/8	28.757
MICRONS	US MESH	TYLER MESH	1	25.400
			7/8	22.225
			3/4	19.050
			5/8	15.875
			1/2	12.700
			7/18	11.113
			3/8	9.525
8000		2 1/2	5/16	8.000
6730		3	0.265	6.730
6350			1/4	6.350
5813		3 1/2	0.221	5.813
4783			3/16	4.783
4899	4	4	0.185	4.899
4000	5	5	0.157	4.000
3327	6	6	0.131	3.327
3175			1/8	3.175
2794	7	7	0.110	2.794
2362	8	8	0.093	2.362
2000	10	9	0.079	2.000
1851	12	10	0.085	1.851
1588			1/18	1.588
1397	14	12	0.055	1.397
1168	16	14	0.048	1.168
1000	18	16	0.039	1.00
841	20	20	0.0331	0.841
707	25	24	0.0278	0.707
595	30	28	0.0234	0.595
500	35	32	0.0197	0.500
420	40	35	0.0165	0.420
354	45	42	0.0139	0.354
297	50	48	0.0117	0.297
250	60	60	0.0098	0.250
210	70	65	0.0083	0.210
177	80	80	0.0089	0.177
149	100	100	0.0058	0.149
125	120	115	0.0049	0.125
105	140	150	0.0041	0.105
88	170	170	0.0035	0.088
74	200	200	0.0029	0.074
63	230	250	0.0025	0.063
53	270	270	0.0021	0.053
44	325	325	0.0017	0.044
37	400	400	0.0014	0.037
32	450	450	0.00128	0.032
25	500	500	0.00098	0.025
20	635	635	0.00079	0.020

"+" before the sieve mesh indicates the particles are retained by the sieve;

"-" before the sieve mesh indicates the particles will pass through the sieve;

Typically 90% or more of the particles will lie within the indicated range

Adapted by D. C. G. from presentation in Chemical Engineering and Mining Review, June 10, 1940.
Original source: Ore Dressing Laboratory of University of Melbourne.

Solids Processing

Mean Particle Sizes Calculated from Particle Size Distributions (PSDs)

Representative particle density functions are shown in the figure below:

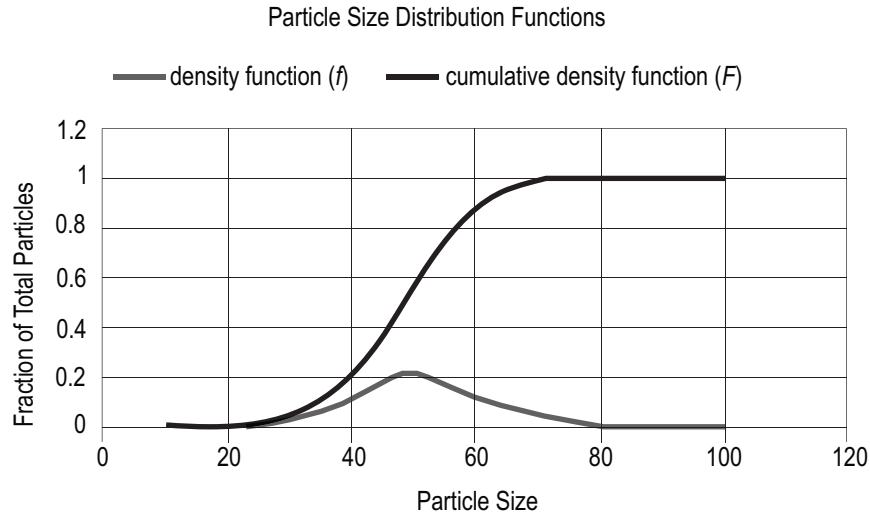

The density function describes the distribution of number of particles (f_N) or volume of particles (f_V) with respect to particle size. At each particle size the cumulative density function provides the fraction of the total particles in terms of number of particles (F_N) and volume of particles (F_V) that are smaller than that size. These density functions can be measured by a variety of means. These functions may also be presented in discrete form where the range of particle sizes is divided into a number (m) of sub-ranges, with each sub-range having a mean size as shown in the following figure:

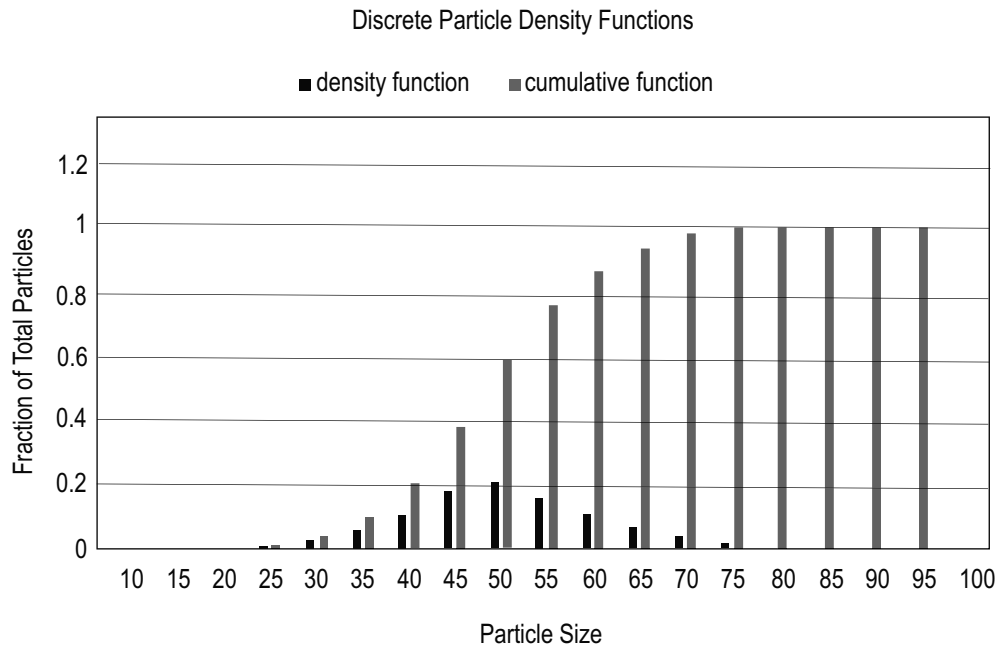

Mean Length (Number Length) Diameter (X_{ML})

$$X_{ML} = \int_0^1 x dF_N = \sum_{i=1}^m x_i \Delta F_N = \frac{\sum_{i=1}^m \frac{\Delta F_V}{x_i^2}}{\sum_{i=1}^m \frac{\Delta F_V}{x_i^3}}$$

Sauter Mean (Surface-Mean) Diameter (X_{SM})

$$X_{SM} = \frac{\int_0^1 x^3 dF_N}{\int_0^1 x^2 dF_N} = \frac{\sum_{i=1}^m x^3 \Delta F_N}{\sum_{i=1}^m x^2 \Delta F_N} = \frac{1}{\int_0^1 \frac{dF_v}{x}} = \frac{1}{\sum_{i=1}^m \frac{\Delta F_v}{x_i}}$$

Mean Volume Diameter (X_{MV})

$$X_{MV} = \sqrt[3]{\int_0^1 x^3 dF_N} = \sqrt[3]{\sum_{i=1}^m x^3 \Delta F_N} = \sqrt[3]{\frac{1}{\sum_{i=1}^m x^3 \frac{\Delta F_v}{x_i^3}}}$$

$$f_N = \frac{dF_N}{dx} \quad \text{and} \quad f_v = \frac{dF_v}{dx}$$

where

- f_N = density function, number of particles as a function of particle size x
- f_v = density function, mass of particles as function of particle size x
- F_N = cumulative density function, fraction (based on number) of particles smaller than size x
- F_v = cumulative density function, fraction (based on mass) of particles smaller than size x
- ΔF_N = fraction of number of particles in a size sub range with mean size x_i
- ΔF_v = fraction of particle mass in a size sub range with mean size x_i
- m = number of size sub ranges used for a discrete particle size distribution
- x = particle size
- x_i = mean size for a sub range of particle size

Crushing and Grinding Equipment Selection

Size-Reduction Operation	Hardness	Range of feeds (in.)		Range of Products (in.)		Reduction Ratio	Types of Equipment
		Max.	Min.	Max.	Min.		
Crushing Primary Secondary	Hard	60	12	20	4	3 to 1	A to B
	Hard	5	1	1	0.2	5 to 1	A to E
	Soft	60	4	2	0.4	10 to 1	C to G
Grinding Coarse Fine	Hard	0.185	0.033	0.023	0.003	10 to 1	D to I
	Hard	0.046	0.0058	0.003	0.00039	15 to 1	H to K
Disintegration Coarse Fine	Soft	0.5	0.065	0.023	0.003	20 to 1	F, I
	Soft	0.156	0.0195	0.003	0.00039	50 to 1	I to K

Types of Size-Reduction Equipment

- A. Jaw crushers
- B. Gyratory crushers
- C. Heavy-duty impact mills
- D. Roll crushers
- E. Dry pans and chaser mills
- F. Shredders
- G. Rotary cutters and dicers
- H. Media mills
- I. Medium peripheral-speed mills
- J. High peripheral-speed mills
- K. Fluid-energy superfine mills

Classifiers: Wet and Dry Operations

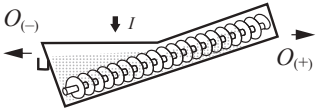
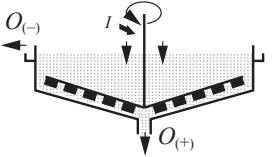
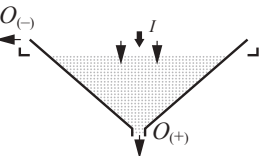
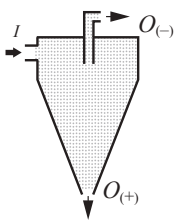
Classifier	(Type*)	Description	Size (m) Width Diameter Max. Length	Limiting Size (max. feed size)	Feed Rate (ton/hr)	Vol. % Solids Feed Overflow Underflow	Power (kW)	Suitability and Applications
SLOPING TANK CLASSIFIER (SPIRAL, RAKE, DRAG) 	(M-S)	Classification occurs near deep end of sloping, elongated pool. Spiral, rake or drag mechanism lifts sands from pool.	0.3 to 7.0 2.4 (spiral) 14	1 mm to 45 μm (25 mm)	5 to 850	Not critical 2 to 20 45 to 65	0.4 to 110	Used for closed circuit grinding, washing and dewatering, desliming; particularly where clean dry underflow is important. (Drag classifier sands not so clean.) In closed circuit grinding discharge mechanism (spirals especially) may give enough lift to eliminate pump.
CYLINDRICAL TANK CLASSIFIER 	(M-S)	Effectively an overloaded thickener. Rotating rake feeds sands to central underflow.	— 3 to 45 —	150 μm to 45 μm (6 mm)	5 to 625	Not critical 0.4 to 8 15 to 25	0.75 to 11	Simple, but gives relatively inefficient separation. Used for primary dewatering where the separations involve large feed volumes, and underflow drainage is not critical.
CONE CLASSIFIER 	(N-S)	Similar to cylindrical tank classifier, except tank is conical to eliminate need for rake.	— 0.6 to 3.7 —	600 μm to 45 μm (6 mm)	2 to 100	Not critical 5 to 30 35 to 60	None	Low cost (simple enough to be made locally), and simplicity can justify relatively inefficient separation. Used for desliming and primary dewatering. Solids buildup can be a problem.
HYDROCYCLONE 	(N-S)	(Pumped) pressure feed generates centrifugal action to give high separating forces, and discharge.	— 0.01 to 1.2 —	300 μm to 5 μm (1400 μm to 45 μm)	to 20 m ³ /min	4 to 35 2 to 15 30 to 50	35 to 400 kN/m ² pressure head	Small cheap device, widely used for closed circuit grinding. Gives relatively efficient separations of fine particles in dilute suspensions.

*M: Mechanical transport of sands to discharge

N: Nonmechanical (gravity or pressure) discharge of underflow

S: Sedimentation classifier

$O_{(-)}$ = Liquid Flow Out

$O_{(+)}$ = Solid Flow In

I = Slurry Flow In

Angle of Repose

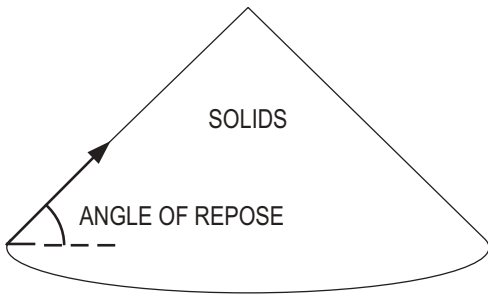

Crystallization Processes

Hydrate Formation Phase Diagram for Magnesium Sulfate-Water System

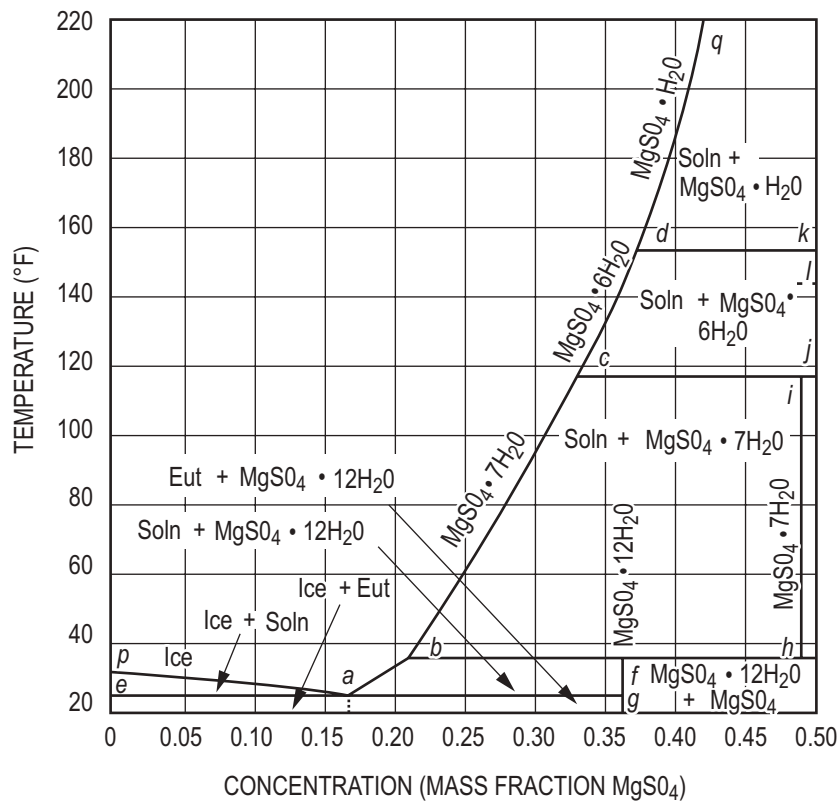

McCabe, Warren L.; Julian C. Smith; and Peter Harriott, *Unit Operations of Chemical Engineering*, 6 ed., New York: McGraw-Hill, 2001.

Cost Estimation

Cost Indexes

Cost indexes are used to update historical cost data to the present. If a purchase cost is available for an item of equipment in year M , the equivalent current cost would be found by:

$$\text{Current \$} = (\text{Cost in year } M) \left(\frac{\text{Current Index}}{\text{Index in year } M} \right)$$

Capital Cost Estimation

Type of plant	Lang factors	
	Fixed capital investment	Total capital investment
Solid processing	4.0	4.7
Solid-fluid processing	4.3	5.0
Fluid processing	5.0	6.0

From Green, Don W., and Robert H. Perry, *Perry's Chemical Engineers' Handbook*, 8th ed., McGraw-Hill, 2008.
 Adapted from M. S. Peters, K. D. Timmerhaus, and R. West, *Plant Design and Economics for Chemical Engineers*, 5th ed., McGraw-Hill, 2004.

Component	Range
<i>Direct costs</i>	
Purchased equipment-delivered (including fabricated equipment and process machinery such as pumps and compressors)	100
Purchased-equipment installation	39–47
Instrumentation and controls (installed)	9–18
Piping (installed)	16–66
Electrical (installed)	10–11
Buildings (including services)	18–29
Yard improvements	10–13
Service facilities (installed)	40–70
Land (if purchase is required)	6
Total direct plant cost	264–346
<i>Indirect costs</i>	
Engineering and supervision	32–33
Construction expenses	34–41
Total direct and indirect plant costs	336–420
Contractor's fee (about 5% of direct and indirect plant costs)	17–21
Contingency (about 10% of direct and indirect plant costs)	36–42
Fixed-capital investment	387–483
Working capital (about 15% of total capital investment)	68–86
Total capital investment	455–569

Scaling of Equipment Costs

The cost of Unit A at one capacity related to the cost of a similar Unit B with X times the capacity of Unit A is approximately X^n times the cost of Unit B.

$$\text{Cost of Unit A} = \text{Cost of Unit B} \left(\frac{\text{Capacity of Unit A}}{\text{Capacity of Unit B}} \right)^n$$

Typical Exponents (n) for Equipment Cost vs. Capacity

Equipment	Size range	Exponent
Dryer, drum, single vacuum	10 to 10 ² ft ²	0.76
Dryer, drum, single atmospheric	10 to 10 ² ft ²	0.40
Fan, centrifugal	10 ³ to 10 ⁴ ft ³ /min	0.44
Fan, centrifugal	2 × 10 ⁴ to 7 × 10 ⁴ ft ³ /min	1.17
Heat exchanger, shell and tube, floating head, c.s.	100 to 400 ft ²	0.60
Heat exchanger, shell and tube, fixed sheet, c.s.	100 to 400 ft ²	0.44
Motor, squirrel cage, induction, 440 volts, explosion proof	5 to 20 hp	0.69
Motor, squirrel cage, induction, 440 volts, explosion proof	20 to 200 hp	0.99
Tray, bubble cup, c.s.	3- to 10-ft diameter	1.20
Tray, sieve, c.s.	3- to 10-ft diameter	0.86

Classification of Cost Estimates

Class of Estimate	Level of Project Definition (as % of Complete Definition)	Typical Purpose of Estimate	Methodology (Estimating Method)	Expected Accuracy Range (+/- Range Relative to Best Index of 1)	Preparation Effort (Relative to Lowest Cost Index of 1)
Class 5	0% to 2%	Screening or Feasibility	Stochastic or Judgement	4 to 20	1
Class 4	1% to 15%	Concept Study or Feasibility	Primarily Stochastic	3 to 12	2 to 4
Class 3	10% to 40%	Budget, Authorization, or Control	Mixed but Primarily Stochastic	2 to 6	3 to 10
Class 2	30% to 70%	Control or Bid/Tender	Primarily Deterministic	1 to 3	5 to 20
Class 1	50% to 100%	Check Estimate or Bid/Tender	Deterministic	1	10 to 100

(From AACE Recommended Practice No. 17R-97 [4], AACE International, 209 Prairie Ave., Morgantown, WV; <http://www.aacei.org>)
Whiting, Wallace B., Turton, Richard, Shaeiwitz, Joseph A., Bhattacharyya, Debangsu, and Bailie, Richard C., *Analysis, Synthesis and Design of Chemical Processes*, 4th ed., Prentice Hall, 2012, p. 165.

Civil Engineering

Geotechnical

Phase Relationships

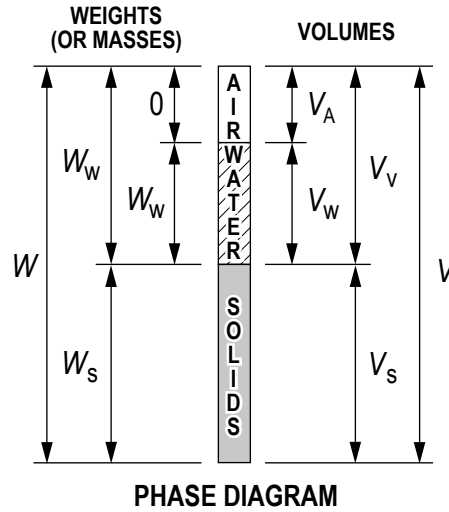

Volume of voids

$$V_v = V_A + V_w$$

Total unit weight

$$\gamma = \frac{W}{V}$$

Saturated unit weight

$$\gamma_{\text{sat}} = \frac{(G_s + e)\gamma_w}{1 + e}$$

$$\gamma_w = 62.4 \text{ lb/ft}^3 \text{ or } 9.81 \text{ kN/m}^3$$

Effective (submerged) unit weight

$$\gamma' = \gamma_{\text{sat}} - \gamma_w$$

Unit weight of solids

$$\gamma_s = \frac{W_s}{V_s}$$

Dry unit weight

$$\gamma_D = \frac{W_s}{V}$$

Water content (%)

$$\omega = \frac{W_w}{W_s} \times 100$$

Specific gravity of soil solids

$$G_s = (W_s/V_s)/\gamma_w$$

Void ratio

$$e = \frac{V_v}{V_s}$$

Porosity

$$n = \frac{V_v}{V} = \frac{e}{1 + e}$$

Degree of saturation (%)

$$S = \frac{V_W}{V_V} \times 100$$

$$S = \frac{\omega G_s}{e}$$

Relative density

$$D_r = [(e_{\max} - e)/(e_{\max} - e_{\min})] \times 100$$

$$= [(\gamma_{D \text{ field}} - \gamma_{D \text{ min}})/(\gamma_{D \text{ max}} - \gamma_{D \text{ min}})][\gamma_{D \text{ max}}/\gamma_{D \text{ field}}] \times 100$$

Relative compaction (%)

$$RC = (\gamma_{D \text{ field}}/\gamma_{D \text{ max}}) \times 100$$

Plasticity index

$$PI = LL - PL$$

LL = liquid limit
 PL = plastic limit

Coefficient of uniformity

$$C_U = D_{60}/D_{10}$$

Coefficient of concavity (or curvature)

$$C_C = (D_{30})^2/(D_{10} \times D_{60})$$

Hydraulic conductivity (also coefficient of permeability)

From constant head test:

$$k = Q/(iAt_e)$$

$$i = dh/dL$$

Q = total quantity of water

From falling head test:

$$k = 2.303[(aL)/(At_e)] \log_{10}(h_1/h_2)$$

where

- A = cross-sectional area of test specimen perpendicular to flow
- a = cross-sectional area of reservoir tube
- t_e = elapsed time
- h_1 = head at time $t = 0$
- h_2 = head at time $t = t_e$
- L = length of soil column

Discharge velocity

$$v = ki$$

Factor of safety against seepage liquefaction

$$FS_s = i_c/i_e$$

$$i_c = (\gamma_{\text{sat}} - \gamma_w)/\gamma_w$$

i_e = seepage exit gradient

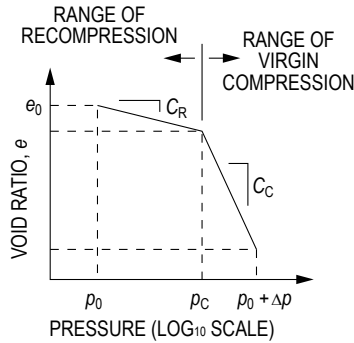

SOIL CONSOLIDATION CURVE OVER CONSOLIDATED CLAY

where

e_0 = initial void ratio (prior to consolidation)

Δe = change in void ratio

p_0 = initial effective consolidation stress σ'_0

p_c = past maximum consolidation stress σ'_c

Δp = induced change in consolidation stress at center of consolidating stratum

$\Delta p = I q_s$

where

I = Stress influence value at center of consolidating stratum

q_s = applied surface stress causing consolidation

If ($p_0 < p_c$ and $p_0 + \Delta p < p_c$), then $\Delta H = \frac{H_0}{1 + e_0} \left[C_R \log \frac{p_0 + \Delta p}{p_0} \right]$

If ($p_0 \geq p_c$ and $p_0 + \Delta p \geq p_c$), then $\Delta H = \frac{H_0}{1 + e_0} \left[C_C \log \frac{p_0 + \Delta p}{p_0} \right]$

If $p_0 < p_c < (p_0 + \Delta p)$, then $\Delta H = \frac{H_0}{1 + e_0} \left[C_R \log \frac{p_c}{p_0} + C_C \log \frac{p_0 + \Delta p}{p_c} \right]$

ΔH = change in thickness of soil layer

Compression index

In virgin compression range: $C_C = \Delta e / \Delta \log p$

By correlation to liquid limit: $C_C = 0.009 (LL - 10)$

Recompression index

In recompression range: $C_R = \Delta e / \Delta \log p$

By correlation to compression index, C_C : $C_R = C_C / 6$

Ultimate consolidation settlement in soil layer

$$S_{ULT} = \epsilon_v H_S$$

where H_S = thickness of soil layer

$$\epsilon_v = \Delta e_{TOT} / (1 + e_0)$$

where Δe_{TOT} = total change in void ratio due to recompression and virgin compression

Approximate settlement (at time $t = t_c$)

$$S_T = U_{AV} S_{ULT}$$

where

U_{AV} = average degree of consolidation

t_c = elapsed time since application of consolidation load

Variation of time factor with degree of consolidation*

U (%)	T_v	U (%)	T_v	U (%)	T_v
0	0	34	0.0907	68	0.377
1	0.00008	35	0.0962	69	0.390
2	0.0003	36	0.102	70	0.403
3	0.00071	37	0.107	71	0.417
4	0.00126	38	0.113	72	0.431
5	0.00196	39	0.119	73	0.446
6	0.00283	40	0.126	74	0.461
7	0.00385	41	0.132	75	0.477
8	0.00502	42	0.138	76	0.493
9	0.00636	43	0.145	77	0.511
10	0.00785	44	0.152	78	0.529
11	0.0095	45	0.159	79	0.547
12	0.0113	46	0.166	80	0.567
13	0.0133	47	0.173	81	0.588
14	0.0154	48	0.181	82	0.610
15	0.0177	49	0.188	83	0.633
16	0.0201	50	0.197	84	0.658
17	0.0227	51	0.204	85	0.684
18	0.0254	52	0.212	86	0.712
19	0.0283	53	0.221	87	0.742
20	0.0314	54	0.230	88	0.774
21	0.0346	55	0.239	89	0.809
22	0.0380	56	0.248	90	0.848
23	0.0415	57	0.257	91	0.891
24	0.0452	58	0.267	92	0.938
25	0.0491	59	0.276	93	0.993
26	0.0531	60	0.286	94	1.055
27	0.0572	61	0.297	95	1.129
28	0.0615	62	0.307	96	1.219
29	0.0660	63	0.318	97	1.336
30	0.0707	64	0.329	98	1.500
31	0.0754	65	0.340	99	1.781
32	0.0803	66	0.352	100	∞
33	0.0855	67	0.364		

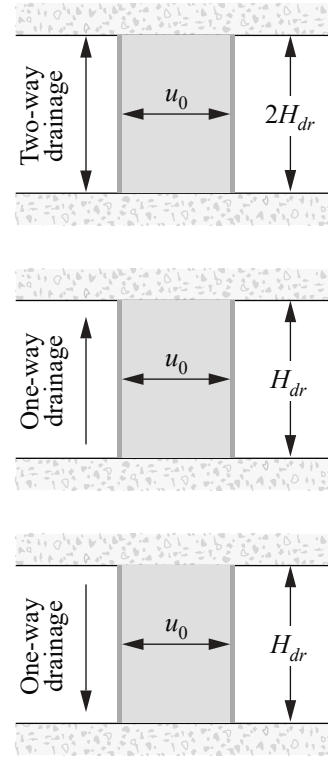

Different types of drainage with u_0 constant

* u_0 constant with depth.

where time factor is $T_v = \frac{c_v t}{H_{dr}^2}$

Das, Braja M., *Fundamentals of Geotechnical Engineering*, Cengage Learning (formerly Brooks/Cole), 2000.

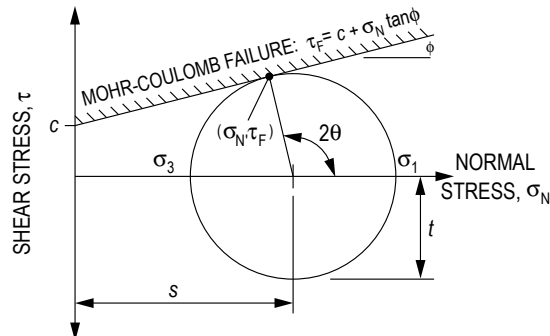

where

s = mean normal stress

t = maximum shear stress

σ_1 = major principal stress

σ_3 = minor principal stress

θ = orientation angle between plane of existing normal stress and plane of major principal stress

Total normal stress

$$\sigma_N = P/A$$

where

P = normal force

A = cross-sectional area over which force acts

Effective stress

$$\sigma' = \sigma - u$$

$$u = h_u \gamma_w$$

where h_u = uplift or pressure head

Shear stress

$$\tau = T/A$$

where T = shearing force

Shear stress at failure

$$\tau_F = c + \sigma_N \tan \phi$$

where

c = cohesion

ϕ = angle of internal friction

Horizontal Stress Profiles and Forces

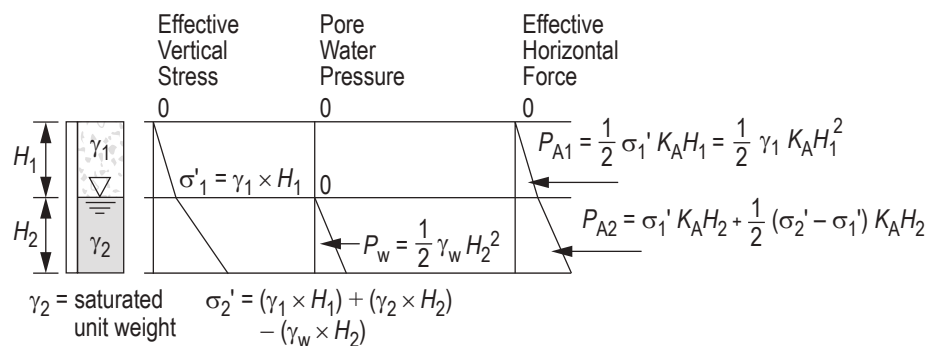

Active forces on retaining wall per unit wall length (as shown):

$$K_A = \text{Rankine active earth pressure coefficient (smooth wall, } c = 0, \text{ level backfill)} = \tan^2 (45^\circ - \phi/2)$$

Passive forces on retaining wall per unit wall length (similar to the active forces shown):

$$K_p = \text{Rankine passive earth pressure coefficient (smooth wall, } c = 0, \text{ level backfill)} = \tan^2 (45^\circ + \phi/2)$$

At rest forces on wall per unit length of wall

K_0 = at rest earth pressure coefficient (smooth wall, $c = 0$, level backfill)

$K_0 \approx 1 - \sin \phi$ for normally consolidated soil

$K_0 = (1 - \sin \phi) \text{OCR}^{\sin \phi}$ for overconsolidated soil where

OCR = overconsolidation ratio

Vertical Stress Profiles

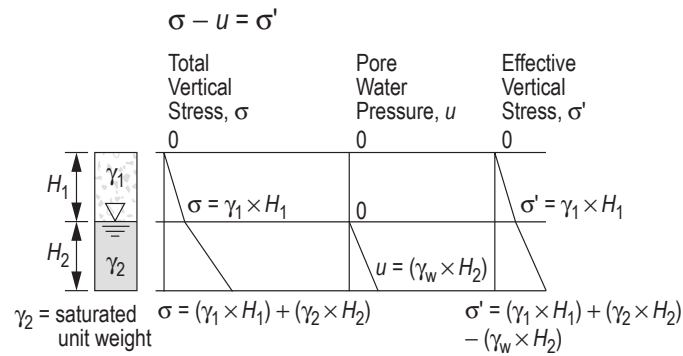

Vertical Stress Profiles with Surcharge

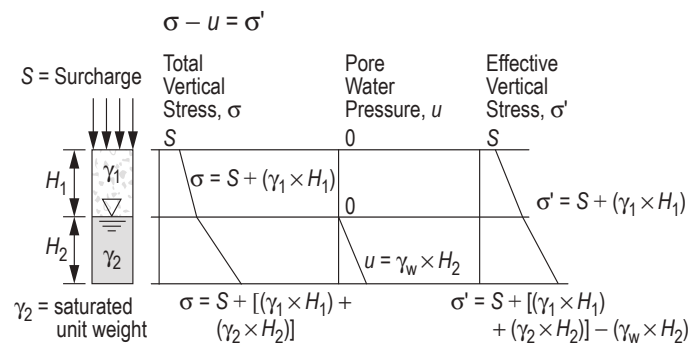

Ultimate Bearing Capacity

$$q_{ULT} = cN_c + \gamma' D_f N_q + \frac{1}{2} \gamma' B N_\gamma$$

where

N_c = bearing capacity factor for cohesion

N_q = bearing capacity factor for depth

N_γ = bearing capacity factor for unit weight

D_f = depth of footing below ground surface

B = width of strip footing

Retaining Walls

$$FS_{\text{overturning}} = \frac{\sum M_R}{M_O}$$

$$FS_{\text{sliding}} = \frac{\sum F_R}{\sum F_D}$$

$$FS_{\text{sliding}} = \frac{(\sum V) \tan \delta + BC_a + P_p}{P_a \cos \alpha}$$

$$FS_{\text{bearing capacity}} = \frac{q_{ULT}}{q_{toe}}$$

$$q_{toe} = \frac{\sum V}{B} \left(1 + \frac{6e}{B} \right)$$

$$e = \frac{B}{2} - \left(\frac{\sum M_R - M_O}{\sum V} \right)$$

where

e = eccentricity

B = width of base

M_R = resisting moment

M_O = overturning moment

F_R = resisting forces

F_D = driving forces

V = vertical forces

$\delta = k_1\phi_2$

$C_a = k_2C_2$

k_1 and k_2 are given, ranging from 1/2 to 2/3

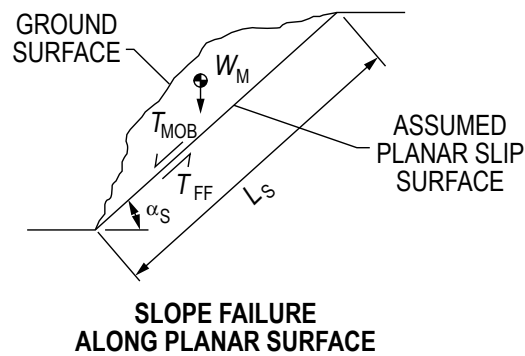

where

FS = factor of safety against slope instability

$$= T_{FF}/T_{MOB}$$

T_{FF} = available shearing resistance along slip surface

$$= cL_S + W_M \cos \alpha_S \tan \phi$$

T_{MOB} = mobilized shear force along slip surface

$$= W_M \sin \alpha_S$$

L_S = length of assumed planar slip surface

W_M = weight of soil above slip surface

α_S = angle of assumed slip surface with respect to horizontal

AASHTO Soil Classification

GENERAL CLASSIFICATION	GRANULAR MATERIALS (35% OR LESS PASSING 0.075 SIEVE)						SILT-CLAY MATERIALS (MORE THAN 35% PASSING 0.075 SIEVE)				
GROUP CLASSIFICATION	A-1		A-3	A-2				A-4	A-5	A-6	A-7-5 A-7-6
	A-1-a	A-1-b		A-2-4	A-2-5	A-2-6	A-2-7				
SIEVE ANALYSIS, PERCENT PASSING: 2.00 mm (No. 10) 0.425 mm (No. 40) 0.075 mm (No. 200)	≤ 50	–	–	–	–	–	–	–	–	–	–
	≤ 30	≤ 50	≥ 51	–	–	–	–	–	–	–	–
	≤ 15	≤ 25	≤ 10	≤ 35	≤ 35	≤ 35	≤ 35	≥ 36	≥ 36	≥ 36	≥ 36
CHARACTERISTICS OF FRACTION PASSING 0.425 SIEVE (No. 40): LIQUID LIMIT PLASTICITY INDEX *	–		–	≤ 40	≥ 41	≤ 40	≥ 41	≤ 40	≥ 41	≤ 40	≥ 41
	6 max		NP	≤ 10	≤ 10	≥ 11	≥ 11	≤ 10	≤ 10	≥ 11	≥ 11
USUAL TYPES OF CONSTITUENT MATERIALS	STONE FRAGMNTS, GRAVEL, SAND		FINE SAND	SILTY OR CLAYEY GRAVEL AND SAND				SILTY SOILS		CLAYEY SOILS	
GENERAL RATING AS A SUBGRADE	EXCELLENT TO GOOD						FAIR TO POOR				

*Plasticity index of A-7-5 subgroup is equal to or less than LL – 30. Plasticity index of A-7-6 subgroup is greater than LL – 30.
NP = Non-plastic (use "0"). Symbol "-" means that the particular sieve analysis is not considered for that classification.

If the soil classification is A4-A7, then calculate the group index (GI) as shown below and report with classification. The higher the GI, the less suitable the soil. Example: A-6 with GI = 15 is less suitable than A-6 with GI = 10.

$$GI = (F - 35) [0.2 + 0.005 (LL - 40)] + 0.01 (F - 15) (PI - 10)$$

where: F = Percent passing No. 200 sieve, expressed as a whole number. This percentage is based only on the material passing the No. 200 sieve.

LL = Liquid limit

PI = Plasticity index

If the computed value of GI < 0, then use GI = 0.

ASTM D2487-11 Standard Practice for Classification of Soils for Engineering Purposes (Unified Soil Classification System)

Criteria for Assigning Group Symbols and Group Names Using Laboratory Tests ^A				Soil Classification		
				Group Symbol	Group Name ^B	
COARSE-GRAINED SOILS	Gravels (more than 50% of coarse fraction retained on No. 4 sieve)	Clean Gravels (Less than 5% fines ^C)	$Cu \geq 4$ and $1 \leq Cc \leq 3^D$	GW	Well-graded gravel ^E	
			$Cu < 4$ and/or $[Cc < 1 \text{ or } Cc > 3]^D$	GP	Poorly graded gravel ^E	
		Gravels with Fines (More than 12% fines ^C)	Fines classify as ML or MH	GM	Silty gravel ^{E, F, G}	
	More than 50% retained on No. 200 sieve	Sands (50% or more of coarse fraction passes No. 4 sieve)	Clean Sands (Less than 5% fines ^H)	$Cu \geq 6$ and $1 \leq Cc \leq 3^D$	SW	Well-graded sand ^I
				$Cu < 6$ and/or $[Cc < 1 \text{ or } Cc > 3]^D$	SP	Poorly graded sand ^I
			Sands with Fines (More than 12% fines ^H)	Fines classify as ML or MH	SM	Silty sand ^{F, G, I}
		Fines classify as CL or CH	SC	Clayey sand ^{F, G, I}		
FINE-GRAINED SOILS	Silts and Clays	inorganic	$PI > 7$ and plots on or above "A" line ^J	CL	Lean clay ^{K, L, M}	
			$PI < 4$ or plots below "A" line ^J	ML	Silt ^{K, L, M}	
	50% or more passes the No. 200 sieve	Liquid limit less than 50	organic	Liquid limit - oven dried / Liquid & #10 < 0.75	OL	Organic clay ^{K, L, M, N} Organic silt ^{K, L, M, O}
			inorganic	PI plots on or above "A" line	CH	Fat clay ^{K, L, M}
		Liquid limit 50 or more	inorganic	PI plots below "A" line	MH	Elastic silt ^{K, L, M}
			organic	Liquid limit - oven dried / Liquid & #10 < 0.75	OH	Organic clay ^{K, L, M, P} Organic silt ^{K, L, M, Q}
HIGHLY ORGANIC SOILS	Primarily organic matter, dark in color, and organic odor			PT	Peat	

^ABased on the material passing the 3-in. (75-mm) sieve.

^BIf field sample contained cobbles or boulders, or both, add "with cobbles or boulders, or both" to group name.

^CGravels with 5 to 12% fines require dual symbols:

- GW-GM well-graded gravel with silt
- GW-GC well-graded gravel with clay
- GP-GM poorly graded gravel with silt
- GP-GC poorly graded gravel with clay

$$^D Cu = D_{60}/D_{10} \quad Cc = \frac{(D_{30})^2}{D_{10} \times D_{60}}$$

^EIf soil contains $\geq 15\%$ sand, add "with sand" to group name.

^FIf fines classify as CL-ML, use dual symbol GC-GM, or SC-SM.

^GIf fines are organic, add "with organic fines" to group name.

^HSands with 5 to 12% fines require dual symbols:

- SW-SM well-graded sand with silt
- SW-SC well-graded sand with clay
- SP-SM poorly graded sand with silt
- SP-SC poorly graded sand with clay

^IIf soil contains $\geq 15\%$ gravel, add "with gravel" to group name.

^JIf Atterberg limits plot in hatched area, soil is a CL-ML, silty clay.

^KIf soil contains 15 to 30% plus No. 200, add "with sand" or "with gravel", whichever is predominant.

^LIf soil contains $\geq 30\%$ plus No. 200, predominantly sand, add "sandy" to group name.

^MIf soil contains $\geq 30\%$ plus No. 200, predominantly gravel, add "gravelly" to group name.

^N $PI \geq 4$ and plots on or above "A" line.

^O $PI < 4$ or plots below "A" line.

^P PI plots on or above "A" line.

^Q PI plots below "A" line.

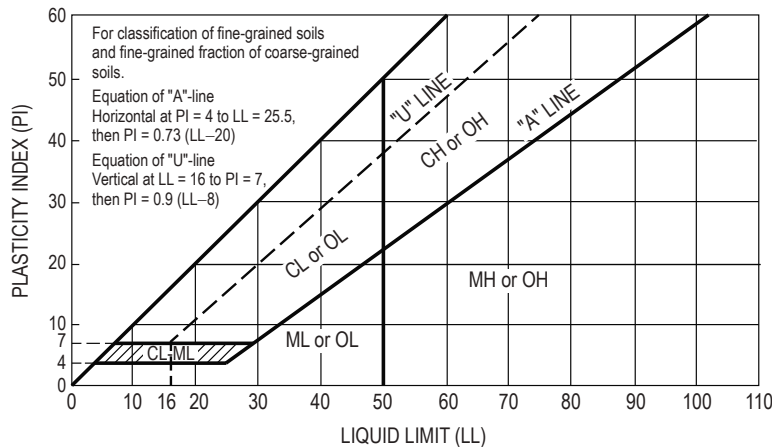

Structural Analysis

Influence Lines for Beams and Trusses

An influence line shows the variation of an effect (reaction, shear and moment in beams, bar force in a truss) caused by moving a unit load across the structure. An influence line is used to determine the position of a moveable set of loads that causes the maximum value of the effect.

Moving Concentrated Load Sets

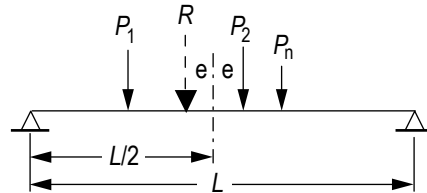

The **absolute maximum moment** produced in a beam by a set of "n" moving loads occurs when the resultant "R" of the load set and an adjacent load are equal distance from the centerline of the beam. In general, two possible load set positions must be considered, one for each adjacent load.

Beam Stiffness and Moment Carryover

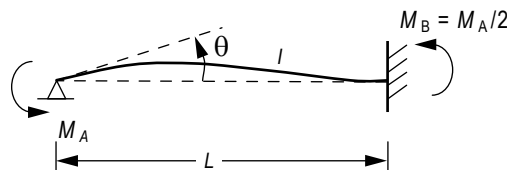

$$\theta = \frac{M L}{4 E I} \Rightarrow M = \left(\frac{4 E I}{L} \right) \theta = k_{AB} \theta$$

$$k_{AB} = \text{stiffness} \quad M_B = M_A/2 = \text{carryover}$$

Truss Deflection by Unit Load Method

The displacement of a truss joint caused by external effects (truss loads, member temperature change, member misfit) is found by applying a unit load at the point that corresponds to the desired displacement.

$$\Delta_{\text{joint}} = \sum_{i=1}^{\text{members}} f_i (\Delta L)_i$$

where

Δ_{joint} = joint displacement at point of application of unit load (+ in direction of unit load)

f_i = force in member i caused by unit load (+ tension)

$(\Delta L)_i$ = change in length caused by external effect (+ for increase in member length):

$$= \left(\frac{F L}{A E} \right)_i \text{ for bar force } F \text{ caused by external load}$$

$$= \alpha L_i (\Delta T)_i \text{ for temperature change in member}$$

(α = coefficient of thermal expansion)

= member misfit

L, A = member length and cross-sectional area

E = member elastic modulus

Frame Deflection by Unit Load Method

The displacement of any point on a frame caused by external loads is found by applying a unit load at that point that corresponds to the desired displacement:

$$\Delta = \sum_{i=1}^{\text{members}} \int_{x=0}^{x=L_i} \frac{m_i M_i}{EI_i} dx$$

where

Δ = displacement at point of application of unit load (+ in direction of unit load)

m_i = moment equation in member i caused by the unit load

M_i = moment equation in member i caused by loads applied to frame

L_i = length of member i

I_i = moment of inertia of member i

If either the real loads or the unit load cause no moment in a member, that member can be omitted from the summation.

Elementary Statically Indeterminate Structures by Force Method of Analysis

The force method is typically used to solve for elements or structures with a single degree of indeterminacy. The method states that the deflection resulting from the removal of a redundant support is equal and opposite to the deflection that the redundant reaction causes, resulting in a net zero deflection.

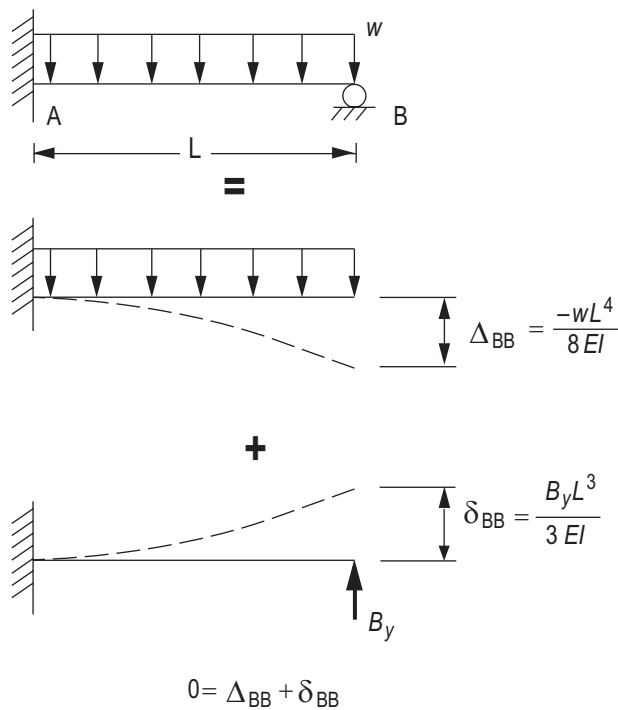
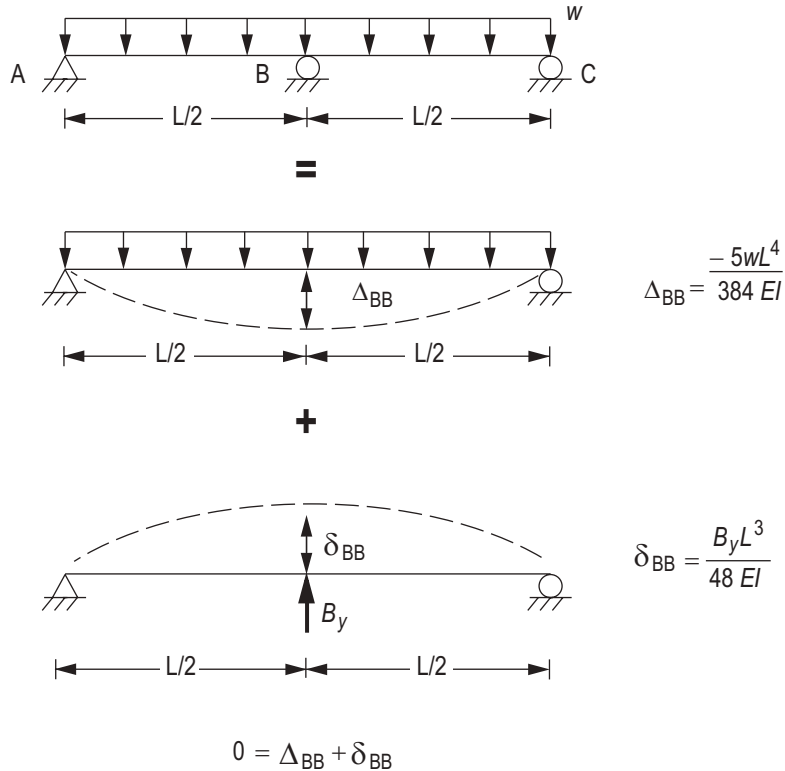

Member Fixed-End Moments (Magnitudes)

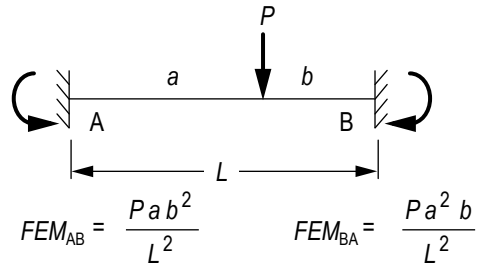
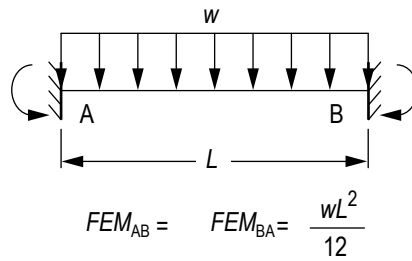

Stability, Determinacy, and Classification of Structures

- m = number of members
- r = number of independent reaction components
- j = number of joints
- c = number of condition equations based on known internal moments or forces, such as internal moment of zero at a hinge

Plane Truss

Static Analysis	Classification
$m + r < 2j$	Unstable
$m + r = 2j$	Stable and statically determinate
$m + r > 2j$	Stable and statically indeterminate

Plane Frame

Static Analysis	Classification
$3m + r < 3j + c$	Unstable
$3m + r = 3j + c$	Stable and statically determinate
$3m + r > 3j + c$	Stable and statically indeterminate

Stability also requires an appropriate arrangement of members and reaction components.

Structural Design

Loads (ASCE 7-16)

Nominal Loads used in LRFD and ASD Load Combinations

- D = dead loads
- E = earthquake loads
- L = live loads (floor)
- L_r = live loads (roof)
- R = rain load
- S = snow load
- W = wind load

Load Combinations using Strength Design (LRFD)

Basic combinations

$$(L_r \text{ or } S \text{ or } R) = \text{largest of } L_r, S, R$$

$$(L \text{ or } 0.5W) = \text{larger of } L, 0.5W$$

Nominal loads used in the following combinations

- $1.4D$
- $1.2D + 1.6L + 0.5(L_r \text{ or } S \text{ or } R)$
- $1.2D + 1.6(L_r \text{ or } S \text{ or } R) + (L \text{ or } 0.5W)$
- $1.2D + 1.0W + L + 0.5(L_r \text{ or } S \text{ or } R)$
- $1.2D + 1.0E + L + 0.2S$
- $0.9D + 1.0W$
- $0.9D + 1.0E$

Load Combinations using Allowable Stress Design (ASD)

Nominal loads used in the following combinations

- D
- $D + L$
- $D + (L_r \text{ or } S \text{ or } R)$
- $D + 0.75L + 0.75(L_r \text{ or } S \text{ or } R)$
- $D + (0.6W \text{ or } 0.7E)$
- $D + 0.75L + 0.75(0.6W) + 0.75(L_r \text{ or } S \text{ or } R)$
- $D + 0.75L + 0.75(0.7E) + 0.75S$
- $0.6D + 0.6W$
- $0.6D + 0.7E$

Live Load Reduction

The effect on a building member of nominal occupancy live loads may often be reduced based on the loaded floor area supported by the member. A typical model used for computing reduced live load (as found in ASCE 7 and many building codes) is:

For members supporting one floor

$$L = L_o \left(0.25 + \frac{15}{\sqrt{K_{LL} A_T}} \right)$$

and

$$L \geq 0.5 L_o$$

For members supporting two or more floors

$$L = L_o \left(0.25 + \frac{15}{\sqrt{K_{LL} A_T}} \right)$$

and

$$L \geq 0.4 L_o$$

where

L = reduced design live load per ft² (m²) of area supported by the member

L_o = unreduced design live load per ft² (m²) of area supported by the member

K_{LL} = live load element factor

$K_{LL} = 4$ for typical columns

$K_{LL} = 2$ for typical beams and girders

A_T = tributary area (ft² or m²)

Flat Roof Snow Loads

$$P_f = 0.7 C_e C_t I_s P_g$$

where

C_e = exposure factor

C_t = thermal factor

I_s = importance factor

P_g = ground snow load (lb/ft²)

Exposure Factor, C_e

Terrain Category	Roof Exposure		
	Fully Exposed	Partially Exposed	Sheltered
B – Suburban	0.9	1.0	1.2
C – Open Terrain	0.9	1.0	1.1
D – Open Water	0.8	0.9	1.0

Fully Exposed = Roofs exposed on all sides with no shelter afforded by terrain, higher structures or trees

Sheltered = Roofs located tight in among conifers that qualify as obstructions

Partially Exposed = all others

Thermal Factor, C_t

All structures except as indicated below	1.0
Unheated and open air structures	1.2
Structures intentionally kept below freezing	1.3

Importance Factor, I_s

Risk Category		Importance Factors	
		Snow, I_s	Seismic, I_e
I	Low Risk	0.8	1.0
II	All Others	1.0	1.0
III	Assembly Buildings	1.1	1.25
IV	Essential Facilities	1.2	1.5

Wind Loads

Velocity pressure at height z

$$q_z = 0.00256 K_z K_{zt} K_d V^2 \text{ (lb/ft}^2\text{)}$$

where

K_d = wind directionality factor = 0.85 for most structures

K_z = velocity pressure exposure coefficient

K_{zt} = topographic factor = 1.0 for flat ground

V = basic wind speed (mph)

Velocity Pressure Exposure Coefficient, K_z

Height above Ground (ft)	Exposure		
	B Suburban	C Open Terrain	D Open Water
0–15	0.57	0.85	1.03
20	0.62	0.90	1.08
25	0.66	0.94	1.12

Design of Reinforced Concrete Components (ACI 318-14)

U.S. Customary units

Definitions

a = depth of equivalent rectangular stress block (in.)

A_g = gross area of concrete section (in²)

A_s = area of longitudinal tension reinforcement (in²)

A_{st} = total area of longitudinal reinforcement (in²)

A_v = area of shear reinforcement within a distance s (in.)

b = width of compression face of member (in.)

β_1 = ratio of depth of rectangular stress block a to depth to neutral axis c

f'_c (psi)	β_1	
$2500 \leq f'_c \leq 4000$	0.85	(a)
$4000 < f'_c < 8000$	$0.85 - \frac{0.05(f'_c - 4000)}{1000}$	(b)
$f'_c \geq 8000$	0.65	(c)

- c = distance from extreme compression fiber to neutral axis (in.)
- d = distance from extreme compression fiber to centroid of longitudinal tension reinforcement (in.)
- d_t = distance from extreme compression fiber to extreme tension steel (in.)
- E_c = modulus of elasticity (psi)
 $= 33w_c^{1.5} \sqrt{f'_c}$
- ϵ_t = net tensile strain in extreme layer of longitudinal tension reinforcement
- f'_c = compressive strength of concrete (psi)
- f_y = yield strength of steel reinforcement (psi)
- M_n = nominal flexural strength at section (in.-lb)
- ϕM_n = design flexural strength at section (in.-lb)
- M_u = factored moment at section (in.-lb)
- P_n = nominal axial compressive load strength of member (lb)
- ϕP_n = design axial compressive load strength of member (lb)
- P_u = factored axial force: to be taken as positive for compression and negative for tension (lb)
- ρ_g = ratio of total reinforcement area to cross-sectional area of column = A_{st}/A_g
- s = center to center spacing of longitudinal shear or torsional reinforcement (in.)
- V_c = nominal shear strength provided by concrete (lb)
- V_n = nominal shear strength at section (lb)
- ϕV_n = design shear strength at section (lb)
- V_s = nominal shear strength provided by reinforcement (lb)
- V_u = factored shear force at section (lb)

Resistance Factors, ϕ

- Tension-controlled sections ($\epsilon_t \geq 0.005$): $\phi = 0.9$
- Compression-controlled sections ($\epsilon_t \leq 0.002$):
 - Members with tied reinforcement $\phi = 0.65$
 - Transition sections ($0.002 < \epsilon_t < 0.005$):
 - Members with tied reinforcement $\phi = 0.48 + 83\epsilon_t$
- Shear and torsion $\phi = 0.75$
- Bearing on concrete $\phi = 0.65$

Beams—Flexure

$$\phi M_n \geq M_u$$

For All Beams

Net tensile strain: $a = \beta_1 c$

$$\epsilon_t = \frac{0.003(d_t - c)}{c} = \frac{0.003(\beta_1 d_t - a)}{a}$$

Singly-Reinforced Beams

$$a = \frac{A_s f_y}{0.85 f'_c b}$$

$$M_n = 0.85 f'_c a b \left(d - \frac{a}{2} \right) = A_s f_y \left(d - \frac{a}{2} \right)$$

Beams—Shear

$$\phi V_n \geq V_u$$

Nominal shear strength:

$$V_n = V_c + V_s$$

$$V_c = 2\lambda\sqrt{f'_c} b_w d$$

where

$$\lambda = 1.0 \text{ for NWC}$$

$$\lambda = 0.75 \text{ for lightweight concrete}$$

$$V_s = \frac{A_v f_y d}{s} \text{ (may not exceed } 8 b_w d \sqrt{f'_c} \text{)}$$

Required and maximum-permitted stirrup spacing s

$$V_u \leq \frac{\phi V_c}{2}: \text{ No stirrups required}$$

$$V_u > \frac{\phi V_c}{2}: \text{ Use the following table (} A_v \text{ given)}$$

ASTM STANDARD REINFORCEMENT BARS			
BAR SIZE	DIAMETER, IN.	AREA, IN ²	WEIGHT, LB/FT
#3	0.375	0.11	0.376
#4	0.500	0.20	0.668
#5	0.625	0.31	1.043
#6	0.750	0.44	1.502
#7	0.875	0.60	2.044
#8	1.000	0.79	2.670
#9	1.128	1.00	3.400
#10	1.270	1.27	4.303
#11	1.410	1.56	5.313
#14	1.693	2.25	7.650
#18	2.257	4.00	13.60

Unified Design Provisions

Internal Stress, Strain, and Forces due to Positive Moment Loading

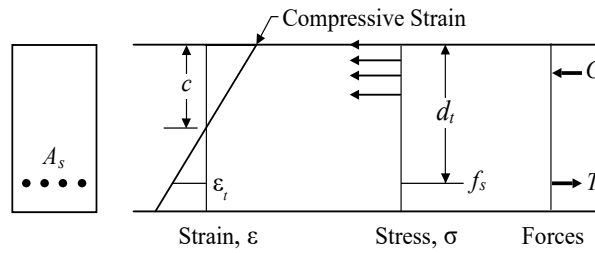

Strain Conditions

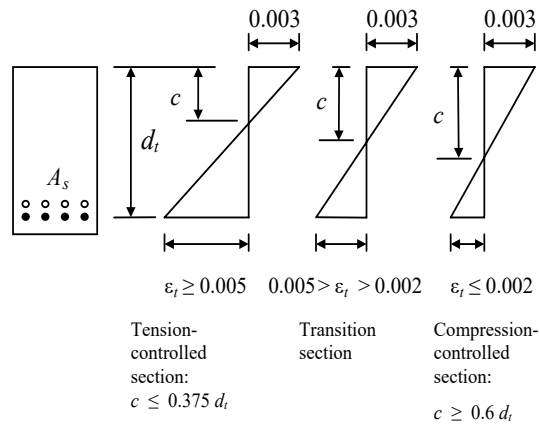

	$\frac{\phi V_c}{2} < V_u \leq \phi V_c$	$V_u > \phi V_c$
Required spacing	Smaller of: $s = \frac{A_v f_y}{50 b_w}$ $s = \frac{A_v f_y}{0.75 b_w \sqrt{f_c'}}$	$V_s = \frac{V_u}{\phi} - V_c$ $s = \frac{A_v f_y d}{V_s}$
Maximum permitted spacing	Smaller of: $s = \frac{d}{2}$ OR $s = 24"$	$V_s \leq 4 b_w d \sqrt{f_c'}$ Smaller of: $s = \frac{d}{2}$ OR $s = 24"$ <hr/> $V_s > 4 b_w d \sqrt{f_c'}$ Smaller of: $s = \frac{d}{4}$ $s = 12"$

Short Columns

Limits for Longitudinal Reinforcements

$$\rho_g = \frac{A_{st}}{A_g}$$

$$0.01 \leq \rho_g \leq 0.08$$

Design Column Strength, Tied Columns

$$\phi P_n = 0.80\phi [0.85 f_c' (A_g - A_{st}) + A_{st} f_y]$$

Nominal Column Strength Interaction Diagram for Rectangular Section with Bars on End Faces and $\gamma = 0.80$ (for instructional use only).

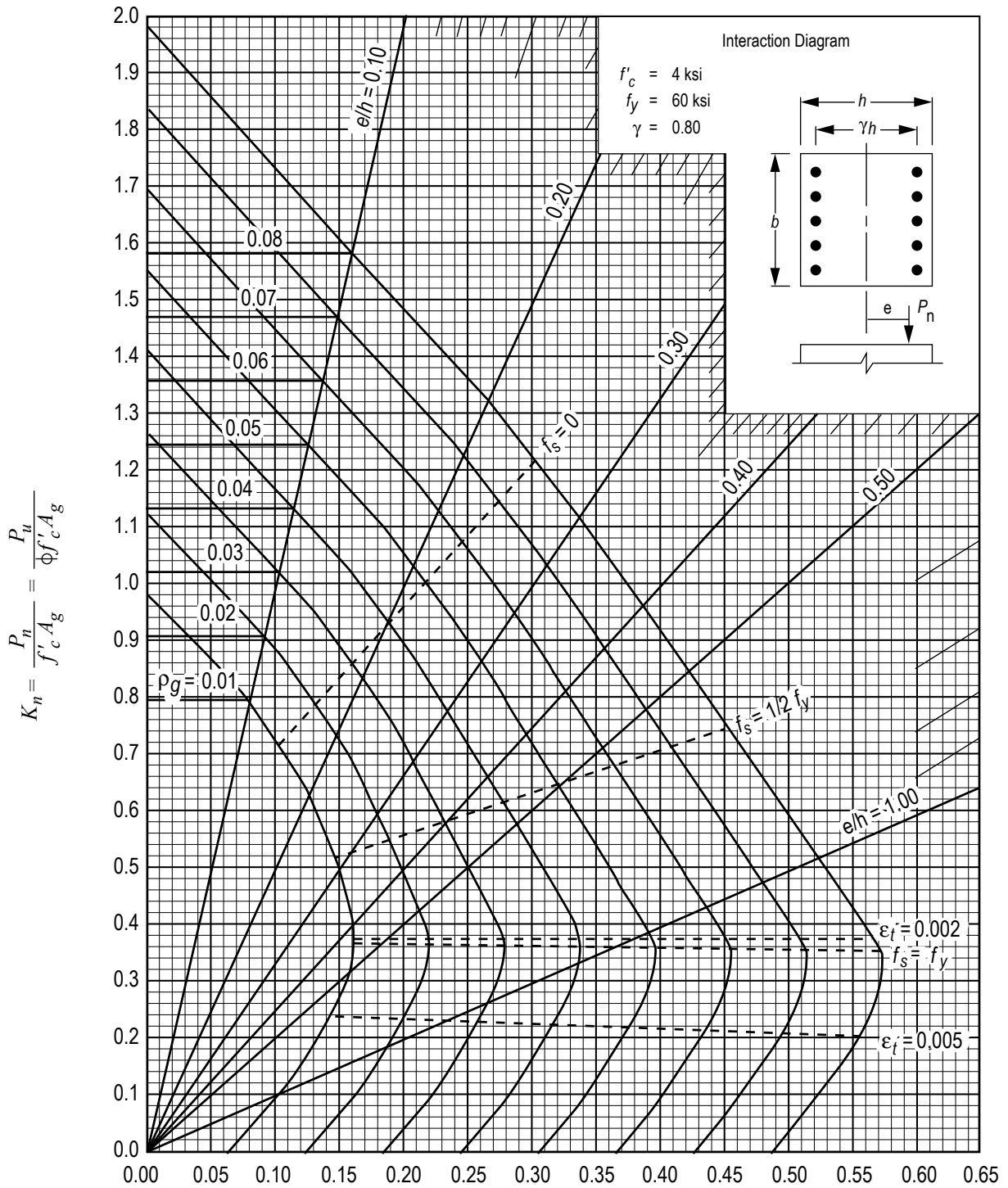

GRAPH A.11

Nilson, Arthur H., David Darwin, and Charles W. Dolan, *Design of Concrete Structures*, 13th ed., McGraw-Hill, 2004.

Factored Strength Interaction Diagram for Rectangular Bars on End Faces and $\gamma = 0.75$

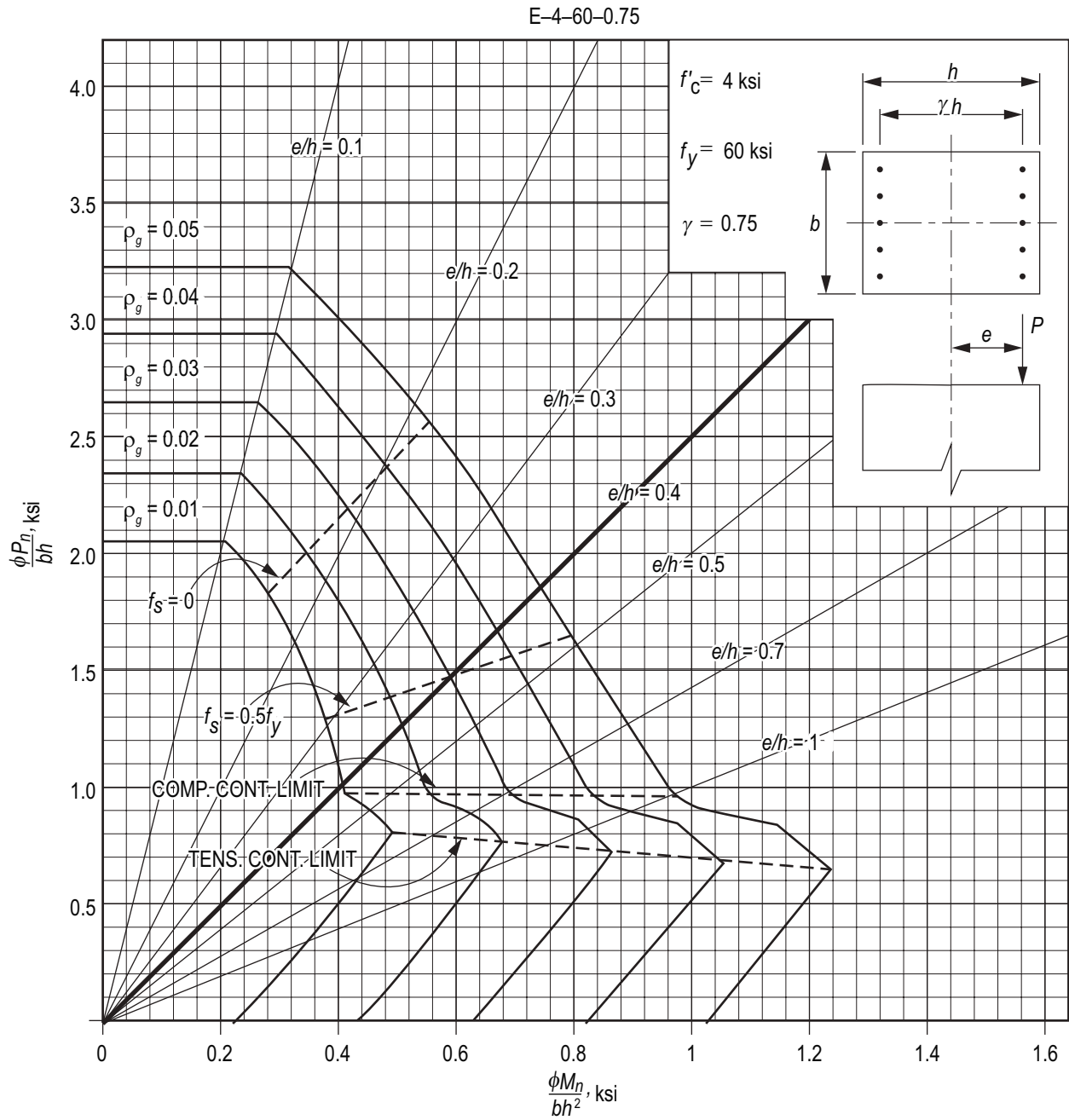

Wight, James K., and James G. MacGregor, *Reinforced Concrete, Mechanics and Design*, 6th ed., Pearson, 2012.

Design of Steel Components

(ANSI/AISC 360-16) LRFD, ASD $E = 29,000 \text{ ksi}$

Beams

For doubly symmetric compact I-shaped members bent about their major axis, the *design flexural strength* $\phi_b M_n$ is determined with $\phi_b = 0.90$ and $\Omega = 1.67$ as follows:

Yielding

$$M_n = M_p = F_y Z_x$$

where

F_y = specified minimum yield stress

Z_x = plastic section modulus about the x-axis

Lateral-Torsional Buckling

Based on bracing where L_b is the length between points that are either braced against lateral displacement of the compression flange or braced against twist of the cross section with respect to the length limits L_p and L_r :

When $L_b \leq L_p$, the limit state of lateral-torsional buckling does not apply.

When $L_p < L_b \leq L_r$

$$M_n = C_b \left[M_p - (M_p - 0.7 F_y S_x) \left(\frac{L_b - L_p}{L_r - L_p} \right) \right] \leq M_p$$

where

$$C_b = \frac{12.5 M_{\max}}{2.5 M_{\max} + 3 M_A + 4 M_B + 3 M_C}$$

M_{\max} = absolute value of maximum moment in the unbraced segment

M_A = absolute value of maximum moment at quarter point of the unbraced segment

M_B = absolute value of maximum moment at centerline of the unbraced segment

M_C = absolute value of maximum moment at three-quarter of the unbraced segment

Shear

The *design shear strength* $\phi_v V_n$ is determined with

$\phi_v = 1.00$ for webs of rolled I-shaped members and is determined as follows:

$\Omega = 1.50$

$V_n = 0.6 F_y A_w C_{vl}$

$C_{vl} = 1.0$

A_w = area of web, the overall depth times the web thickness dt_w (in² or mm²)

Columns

The *design compressive strength* $\phi_c P_n$ is determined with $\phi_c = 0.90$ and $\Omega = 1.67$ for flexural buckling of members without slender elements and is determined as follows:

$$P_n = F_{cr} A_g$$

where the critical stress F_{cr} is determined as follows:

(a) When $\frac{Lc}{r} \leq 4.71 \sqrt{\frac{E}{F_y}}$, $F_{cr} = [0.658 \frac{F_y}{F_e}] F_y$

(b) When $\frac{Lc}{r} > 4.71 \sqrt{\frac{E}{F_y}}$, $F_{cr} = 0.877 F_e$

where

$L_c = KL =$ effective length of member (in.)

$F_e =$ elastic buckling stress $= \pi^2 E / (KL/r)^2$

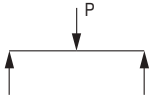
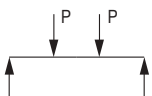
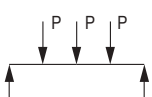
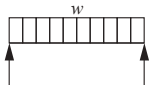
VALUES OF C_b FOR SIMPLY SUPPORTED BEAMS		
LOAD	LATERAL BRACING ALONG SPAN	C_b
	NONE LOAD AT MIDPOINT	1.32
	AT LOAD POINT	1.67
	NONE LOADS AT THIRD POINTS	1.14
	AT LOAD POINTS LOADS SYMMETRICALLY PLACED	1.67
	NONE LOADS AT QUARTER POINTS	1.14
	AT LOAD POINTS LOADS AT QUARTER POINTS	1.67
	NONE	1.14
	AT MIDPOINT	1.30
	AT THIRD POINTS	1.45
	AT QUARTER POINTS	1.52
	AT FIFTH POINTS	1.56

NOTE: LATERAL BRACING MUST ALWAYS BE PROVIDED AT POINTS OF SUPPORT PER AISC SPECIFICATION CHAPTER F.

Adapted from *Steel Construction Manual*, 14th ed., AISC, 2011.

Tension Members

Flat Bars or Angles, Bolted or Welded

Definitions

Bolt diameter: d_b

Nominal hole diameter: $d_h = d_b + \frac{1}{16}$ "

Gross width of member: b_g

Member thickness: t

Connection eccentricity: \bar{x}

Gross area: $A_g = b_g t$ (use tabulated areas for angles)

Net area (parallel holes): $A_n = \left[b_g - \Sigma \left(d_b + \frac{1}{16} \right) \right] t$

Net area (staggered holes):

$A_n = \left[b_g - \Sigma \left(d_b + \frac{1}{16} \right) + \Sigma \frac{s^2}{4g} \right] t$

$s =$ longitudinal spacing of consecutive holes

$g =$ transverse spacing between lines of holes

Effective area (bolted members):

$$A_e = UA_n \left\{ \begin{array}{l} \text{Flat bars: } U = 1.0 \\ U = 1 - \bar{x}/L \text{ All tension members where the tension load is} \\ \text{transmitted to some but not all the elements by fasteners or welds} \end{array} \right.$$

Effective area (welded members):

$$A_e = UA_n \left\{ \begin{array}{l} \text{Flat bars or angles with transverse welds: } U = 1.0 \\ \text{Flat bars of width "w", longitudinal welds of length "L" only:} \\ \quad U = 1.0 \text{ (} L \geq 2w \text{)} \\ \quad U = 0.87 \text{ (} 2w > L \geq 1.5w \text{)} \\ \quad U = 0.75 \text{ (} 1.5w > L > w \text{)} \\ \text{Angles with longitudinal welds only} \\ \quad U = 1 - \bar{x}/L \end{array} \right.$$

Limit States and Available Strengths

Yielding: $\phi_y = 0.90$
 $\dot{P}_n = F_y A_g$
 $\Omega = 1.67$

Rupture: $\phi_r = 0.75$
 $\dot{P}_n = F_u A_e$
 $\Omega = 2.00$

Block shear: $\phi = 0.75$
 $\Omega = 2.00$
 $U_{bs} = 1.0$ (flat bars and angles)
 A_{gv} = gross area for shear
 A_{nv} = net area for shear
 A_{nt} = net area for tension
 $R_n = \text{Smaller} \left\{ \begin{array}{l} F_u [0.6A_{nv} + U_{bs}A_{nt}] \\ [0.6F_y A_{gv} + U_{bs}F_u A_{nt}] \end{array} \right.$

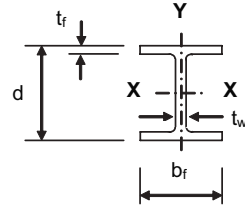

Table 1-1: W Shapes Dimensions and Properties

Shape	Area	Depth	Web	Flange		Axis X-X				Axis Y-Y	
	A	d	t_w	b_f	t_f	I	S	r	Z	I	r
	In. ²	In.	In.	In.	In.	In. ⁴	In. ³	In.	In. ³	In. ⁴	In.
W24X68	20.1	23.7	0.415	8.97	0.585	1830	154	9.55	177	70.4	1.87
W24X62	18.2	23.7	0.430	7.04	0.590	1550	131	9.23	153	34.5	1.38
W24X55	16.3	23.6	0.395	7.01	0.505	1350	114	9.11	134	29.1	1.34
W21X73	21.5	21.2	0.455	8.30	0.740	1600	151	8.64	172	70.6	1.81
W21X68	20.0	21.1	0.430	8.27	0.685	1480	140	8.60	160	64.7	1.80
W21X62	18.3	21.0	0.400	8.24	0.615	1330	127	8.54	144	57.5	1.77
W21X55	16.2	20.8	0.375	8.22	0.522	1140	110	8.40	126	48.4	1.73
W21X57	16.7	21.1	0.405	6.56	0.650	1170	111	8.36	129	30.6	1.35
W21X50	14.7	20.8	0.380	6.53	0.535	984	94.5	8.18	110	24.9	1.30
W21X48	14.1	20.6	0.350	8.14	0.430	959	93.0	8.24	107	38.7	1.66
W21X44	13.0	20.7	0.350	6.50	0.450	843	81.6	8.06	95.4	20.7	1.26
W18X71	20.8	18.5	0.495	7.64	0.810	1170	127	7.50	146	60.3	1.70
W18X65	19.1	18.4	0.450	7.59	0.750	1070	117	7.49	133	54.8	1.69
W18X60	17.6	18.2	0.415	7.56	0.695	984	108	7.47	123	50.1	1.68
W18X55	16.2	18.1	0.390	7.53	0.630	890	98.3	7.41	112	44.9	1.67
W18X50	14.7	18.0	0.355	7.50	0.570	800	88.9	7.38	101	40.1	1.65
W18X46	13.5	18.1	0.360	6.06	0.605	712	78.8	7.25	90.7	22.5	1.29
W18X40	11.8	17.9	0.315	6.02	0.525	612	68.4	7.21	78.4	19.1	1.27
W16X67	19.7	16.3	0.395	10.2	0.67	954	117	6.96	130	119	2.46
W16X57	16.8	16.4	0.430	7.12	0.715	758	92.2	6.72	105	43.1	1.60
W16X50	14.7	16.3	0.380	7.07	0.630	659	81.0	6.68	92.0	37.2	1.59
W16X45	13.3	16.1	0.345	7.04	0.565	586	72.7	6.65	82.3	32.8	1.57
W16X40	11.8	16.0	0.305	7.00	0.505	518	64.7	6.63	73.0	28.9	1.57
W16X36	10.6	15.9	0.295	6.99	0.430	448	56.5	6.51	64.0	24.5	1.52
W14X74	21.8	14.2	0.450	10.1	0.785	795	112	6.04	126	134	2.48
W14X68	20.0	14.0	0.415	10.0	0.720	722	103	6.01	115	121	2.46
W14X61	17.9	13.9	0.375	9.99	0.645	640	92.1	5.98	102	107	2.45
W14X53	15.6	13.9	0.370	8.06	0.660	541	77.8	5.89	87.1	57.7	1.92
W14X48	14.1	13.8	0.340	8.03	0.595	484	70.2	5.85	78.4	51.4	1.91
W12X79	23.2	12.4	0.470	12.1	0.735	662	107	5.34	119	216	3.05
W12X72	21.1	12.3	0.430	12.0	0.670	597	97.4	5.31	108	195	3.04
W12X65	19.1	12.1	0.390	12.0	0.605	533	87.9	5.28	96.8	174	3.02
W12X58	17.0	12.2	0.360	10.0	0.640	475	78.0	5.28	86.4	107	2.51
W12X53	15.6	12.1	0.345	9.99	0.575	425	70.6	5.23	77.9	95.8	2.48
W12X50	14.6	12.2	0.370	8.08	0.640	391	64.2	5.18	71.9	56.3	1.96
W12X45	13.1	12.1	0.335	8.05	0.575	348	57.7	5.15	64.2	50.0	1.95
W12X40	11.7	11.9	0.295	8.01	0.515	307	51.5	5.13	57.0	44.1	1.94
W10x60	17.6	10.2	0.420	10.1	0.680	341	66.7	4.39	74.6	116	2.57
W10x54	15.8	10.1	0.370	10.0	0.615	303	60.0	4.37	66.6	103	2.56
W10x49	14.4	10.0	0.340	10.0	0.560	272	54.6	4.35	60.4	93.4	2.54
W10x45	13.3	10.1	0.350	8.02	0.620	248	49.1	4.32	54.9	53.4	2.01
W10x39	11.5	9.92	0.315	7.99	0.530	209	42.1	4.27	46.8	45.0	1.98

Adapted from *Steel Construction Manual*, 14th ed., AISC, 2011.

Z_x	AISC Table 3-2							
	W Shapes – Selection by Z_x							
		$F_y = 50 \text{ ksi}$	$\phi_b = 0.90$	$\phi_v = 1.00$				
Shape	Z_x in.³	$\phi_b M_{px}$ kip-ft	$\phi_b M_{rx}$ kip-ft	$\phi_b BF$ kips	L_p ft.	L_r ft.	I_x in.⁴	$\phi_v V_{nx}$ kips
W24 x 55	134	503	299	22.2	4.73	13.9	1350	251
W18 x 65	133	499	307	14.9	5.97	18.8	1070	248
W12 x 87	132	495	310	5.76	10.8	43.0	740	194
W16 x 67	130	488	307	10.4	8.69	26.1	954	194
W10 x 100	130	488	294	4.01	9.36	57.7	623	226
W21 x 57	129	484	291	20.1	4.77	14.3	1170	256
W21 x 55	126	473	289	16.3	6.11	17.4	1140	234
W14 x 74	126	473	294	8.03	8.76	31.0	795	191
W18 x 60	123	461	284	14.5	5.93	18.2	984	227
W12 x 79	119	446	281	5.67	10.8	39.9	662	175
W14 x 68	115	431	270	7.81	8.69	29.3	722	175
W10 x 88	113	424	259	3.95	9.29	51.1	534	197
W18 x 55	112	420	258	13.9	5.90	17.5	890	212
W21 x 50	110	413	248	18.3	4.59	13.6	984	237
W12 x 72	108	405	256	5.59	10.7	37.4	597	158
W21 x 48	107	398	244	14.7	6.09	16.6	959	217
W16 x 57	105	394	242	12.0	5.56	18.3	758	212
W14 x 61	102	383	242	7.46	8.65	27.5	640	156
W18 x 50	101	379	233	13.1	5.83	17.0	800	192
W10 x 77	97.6	366	225	3.90	9.18	45.2	455	169
W12 x 65	96.8	356	231	5.41	11.9	35.1	533	142
W21 x 44	95.4	358	214	16.8	4.45	13.0	843	217
W16 x 50	92.0	345	213	11.4	5.62	17.2	659	185
W18 x 46	90.7	340	207	14.6	4.56	13.7	712	195
W14 x 53	87.1	327	204	7.93	6.78	22.2	541	155
W12 x 58	86.4	324	205	5.66	8.87	29.9	475	132
W10 x 68	85.3	320	199	3.86	9.15	40.6	394	147
W16 x 45	82.3	309	191	10.8	5.55	16.5	586	167
W18 x 40	78.4	294	180	13.3	4.49	13.1	612	169
W14 x 48	78.4	294	184	7.66	6.75	21.1	484	141
W12 x 53	77.9	292	185	5.48	8.76	28.2	425	125
W10 x 60	74.6	280	175	3.80	9.08	36.6	341	129
W16 x 40	73.0	274	170	10.1	5.55	15.9	518	146
W12 x 50	71.9	270	169	5.97	6.92	23.9	391	135
W8 x 67	70.1	263	159	2.60	7.49	47.7	272	154
W14 x 43	69.6	261	164	7.24	6.68	20.0	428	125
W10 x 54	66.6	250	158	3.74	9.04	33.7	303	112
W18 x 35	66.5	249	151	12.3	4.31	12.4	510	159
W12 x 45	64.2	241	151	5.75	6.89	22.4	348	121
W16 x 36	64.0	240	148	9.31	5.37	15.2	448	140
W14 x 38	61.5	231	143	8.10	5.47	16.2	385	131
W10 x 49	60.4	227	143	3.67	8.97	31.6	272	102
W8 x 58	59.8	224	137	2.56	7.42	41.7	228	134
W12 x 40	57.0	214	135	5.50	6.85	21.1	307	106
W10 x 45	54.9	206	129	3.89	7.10	26.9	248	106

$$M_{rx} = (0.7F_y)S_x$$

$$BF = \frac{M_{px} - M_{rx}}{L_r - L_p}$$

Adapted from *Steel Construction Manual*, 14th ed., AISC, 2011.

TABLE C-A-7.1
AISC APPROXIMATE VALUES OF EFFECTIVE LENGTH FACTOR, K

BUCKLED SHAPE OF COLUMN IS SHOWN BY DASHED LINE.	(a)	(b)	(c)	(d)	(e)	(f)
THEORETICAL K VALUE	0.5	0.7	1.0	1.0	2.0	2.0
AISC-RECOMMENDED DESIGN VALUE WHEN IDEAL CONDITIONS ARE APPROXIMATED	0.65	0.80	1.2	1.0	2.10	2.0
END CONDITION CODE	<p> ROTATION FIXED AND TRANSLATION FIXED ROTATION FREE AND TRANSLATION FIXED ROTATION FIXED AND TRANSLATION FREE ROTATION FREE AND TRANSLATION FREE </p>					

FOR COLUMN ENDS SUPPORTED BY, BUT NOT RIGIDLY CONNECTED TO, A FOOTING OR FOUNDATION, G IS THEORETICALLY INFINITY BUT UNLESS DESIGNED AS A TRUE FRICTION-FREE PIN, MAY BE TAKEN AS 10 FOR PRACTICAL DESIGNS. IF THE COLUMN END IS RIGIDLY ATTACHED TO A PROPERLY DESIGNED FOOTING, G MAY BE TAKEN AS 1.0. SMALLER VALUES MAY BE USED IF JUSTIFIED BY ANALYSIS.

AISC Figure C-A-7.1

Alignment chart, sidesway inhibited (braced frame)

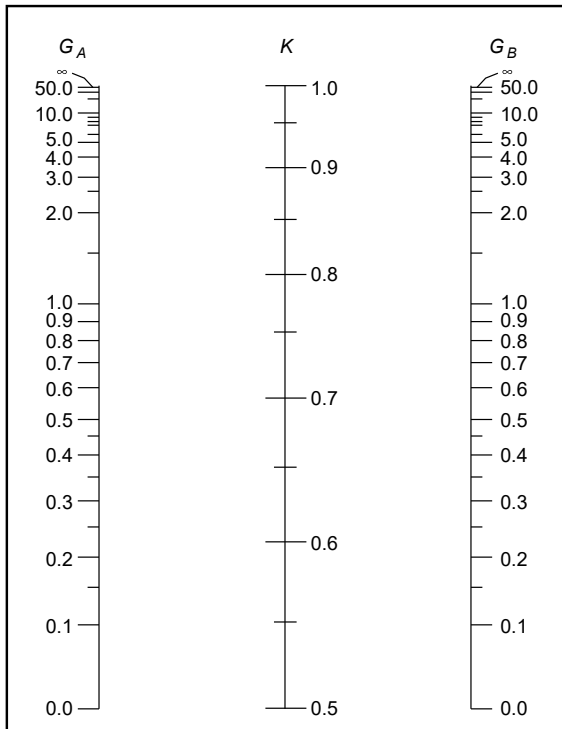

AISC Figure C-A-7.2

Alignment chart, sidesway uninhibited (moment frame)

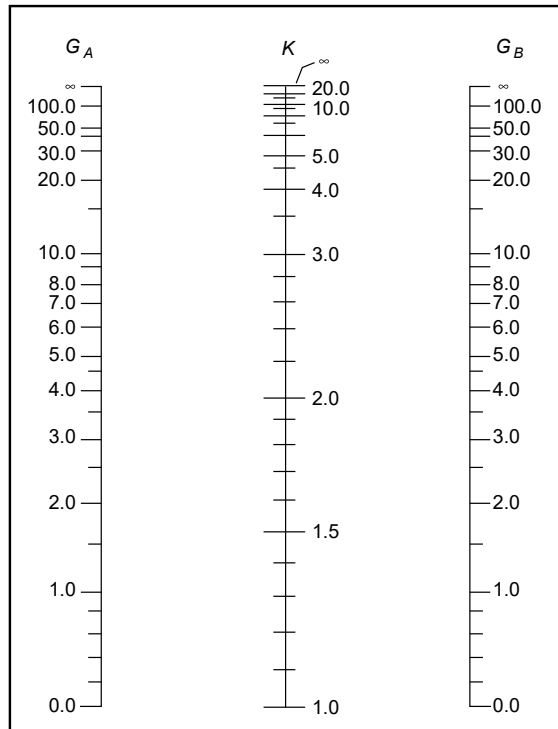

AISC Table 4-14
 Available Critical Stress $\phi_c F_{cr}$ for Compression Members
 $F_y = 50$ ksi $\phi_c = 0.90$

$\frac{KL}{r}$	ϕF_{cr} ksi	$\frac{KL}{r}$	ϕF_{cr} ksi	$\frac{KL}{r}$	ϕF_{cr} ksi	$\frac{KL}{r}$	ϕF_{cr} ksi	$\frac{KL}{r}$	ϕF_{cr} ksi
1	45.0	41	39.8	81	27.9	121	15.4	161	8.72
2	45.0	42	39.5	82	27.5	122	15.2	162	8.61
3	45.0	43	39.3	83	27.2	123	14.9	163	8.50
4	44.9	44	39.1	84	26.9	124	14.7	164	8.40
5	44.9	45	38.8	85	26.5	125	14.5	165	8.30
6	44.9	46	38.5	86	26.2	126	14.2	166	8.20
7	44.8	47	38.3	87	25.9	127	14.0	167	8.10
8	44.8	48	38.0	88	25.5	128	13.8	168	8.00
9	44.7	49	37.7	89	25.2	129	13.6	169	7.89
10	44.7	50	37.5	90	24.9	130	13.4	170	7.82
11	44.6	51	37.2	91	24.6	131	13.2	171	7.73
12	44.5	52	36.9	92	24.2	132	13.0	172	7.64
13	44.4	53	36.7	93	23.9	133	12.8	173	7.55
14	44.4	54	36.4	94	23.6	134	12.6	174	7.46
15	44.3	55	36.1	95	23.3	135	12.4	175	7.38
16	44.2	56	35.8	96	22.9	136	12.2	176	7.29
17	44.1	57	35.5	97	22.6	137	12.0	177	7.21
18	43.9	58	35.2	98	22.3	138	11.9	178	7.13
19	43.8	59	34.9	99	22.0	139	11.7	179	7.05
20	43.7	60	34.6	100	21.7	140	11.5	180	6.97
21	43.6	61	34.3	101	21.3	141	11.4	181	6.90
22	43.4	62	34.0	102	21.0	142	11.2	182	6.82
23	43.3	63	33.7	103	20.7	143	11.0	183	6.75
24	43.1	64	33.4	104	20.4	144	10.9	184	6.67
25	43.0	65	33.0	105	20.1	145	10.7	185	6.60
26	42.8	66	32.7	106	19.8	146	10.6	186	6.53
27	42.7	67	32.4	107	19.5	147	10.5	187	6.46
28	42.5	68	32.1	108	19.2	148	10.3	188	6.39
29	42.3	69	31.8	109	18.9	149	10.2	189	6.32
30	42.1	70	31.4	110	18.6	150	10.0	190	6.26
31	41.9	71	31.1	111	18.3	151	9.91	191	6.19
32	41.8	72	30.8	112	18.0	152	9.78	192	6.13
33	41.6	73	30.5	113	17.7	153	9.65	193	6.06
34	41.4	74	30.2	114	17.4	154	9.53	194	6.00
35	41.2	75	29.8	115	17.1	155	9.40	195	5.94
36	40.9	76	29.5	116	16.8	156	9.28	196	5.88
37	40.7	77	29.2	117	16.5	157	9.17	197	5.82
38	40.5	78	28.8	118	16.2	158	9.05	198	5.76
39	40.3	79	28.5	119	16.0	159	8.94	199	5.70
40	40.0	80	28.2	120	15.7	160	8.82	200	5.65

Adapted from *Steel Construction Manual*, 15th ed., AISC 2017.

 Selected W14, W12, W10		AISC Table 4-1 Available Strength in Axial Compression, kips—W shapes LRFD: ϕP_n												$F_y = 50$ ksi $\phi_c = 0.90$		
		W14					W12					W10				
Shape	wt/ft	74	68	61	53	48	58	53	50	45	40	60	54	49	45	39
		0		980	899	806	702	636	767	701	657	590	526	794	712	649
6		922	844	757	633	573	722	659	595	534	475	750	672	612	543	469
7		901	826	740	610	552	707	644	574	516	458	734	658	599	525	452
8		878	804	721	585	529	689	628	551	495	439	717	643	585	505	435
9		853	781	700	557	504	670	610	526	472	419	698	625	569	483	415
10		826	755	677	528	477	649	590	499	448	397	677	607	551	460	395
11		797	728	652	497	449	627	569	471	422	375	655	586	533	435	373
12		766	700	626	465	420	603	547	443	396	351	631	565	513	410	351
13		734	670	599	433	391	578	525	413	370	328	606	543	493	384	328
14		701	639	572	401	361	553	501	384	343	304	581	520	471	358	305
15		667	608	543	369	332	527	477	354	317	280	555	496	450	332	282
16		632	576	515	338	304	500	452	326	291	257	528	472	428	306	260
17		598	544	486	308	276	473	427	297	265	234	501	448	405	281	238
18		563	512	457	278	250	446	402	270	241	212	474	423	383	256	216
19		528	480	428	250	224	420	378	244	217	191	447	399	360	233	195
20		494	448	400	226	202	393	353	220	196	172	420	375	338	210	176
22		428	387	345	186	167	342	306	182	162	142	367	327	295	174	146
24		365	329	293	157	140	293	261	153	136	120	317	282	254	146	122
26		311	281	250	133	120	249	222	130	116	102	270	241	216	124	104
28		268	242	215	115	103	215	192	112	99.8	88.0	233	208	186	107	90.0
30		234	211	187	100	89.9	187	167	97.7	87.0	76.6	203	181	162	93.4	78.4
32		205	185	165	88.1		165	147	82.9	76.4	67.3	179	159	143	82.1	68.9
34		182	164	146			146	130				158	141	126		
36		162	146	130			130	116				141	126	113		
38		146	131	117			117	104				127	113	101		
40		131	119	105			105	93.9				114	102	91.3		

Effective length KL (ft) with respect to least radius of gyration r_y

Hydrology/Water Resources

NRCS (SCS) Rainfall-Runoff

$$Q = \frac{(P - 0.2S)^2}{P + 0.8S}$$

$$S = \frac{1,000}{CN} - 10$$

$$CN = \frac{1,000}{S + 10}$$

where

P = precipitation (inches)

S = maximum basin retention (inches)

Q = runoff (inches)

CN = curve number

Rational Formula

$$Q = CIA$$

where

A = watershed area (acres)

C = runoff coefficient

I = rainfall intensity (in./hr)

Q = peak discharge (cfs)

Hydrologic Mass Balance (Budget)

Surface Water System Hydrologic Budget

$$P + Q_{in} - Q_{out} + Q_g - E_s - T_s - I = \Delta S_s$$

P = precipitation

Q_{in} = surface water flow into the system

Q_{out} = surface water flow out of the system

Q_g = groundwater flow into the stream

E_s = surface evaporation

T_s = transpiration

I = Infiltration

ΔS = change in water storage of surface water system

Pan Evaporation

The lake evaporation E_L is related to the pan evaporation E_p by the expression:

$$E_L = P_c E_p$$

where P_c = pan coefficient (P_c ranges from 0.3 to 0.85; common $P_c = 0.7$)

Evapotranspiration Rates for Grasses

Grass-Reference Evapotranspiration Rates

Range (mm/day)	Classification
0–2.5	Low
2.5–5.0	Moderate
5.0–7.5	High
>7.5	Very High

Source: Allen et al. (1998)

Chin, David, *Water-Resources Engineering*, 2nd ed., Pearson, 2006, p. 542.

Lake Classification

Lake Classification Based on Productivity

Lake Classification		Chlorophyll <i>a</i> Concentration (µg/L)	Secchi Depth (m)	Total Phosphorus Concentration (µg/L)
Oligotrophic	Average	1.7	9.9	8
	Range	0.3–4.5	5.4–28.3	3.0–17.7
Mesotrophic	Average	4.7	4.2	26.7
	Range	3–11	1.5–8.1	10.9–95.6
Eutrophic	Average	14.3	2.5	84.4
	Range	3–78	0.0–7.0	15–386

Source: Wetzel, 1983

Davis, MacKenzie and David Cornwell, *Introduction to Environmental Engineering*, 4th ed., New York: McGraw-Hill, 2008, p. 394.

Darcy's Law

$$Q = -KA \frac{dh}{dx}$$

where

Q = discharge rate (ft³/sec or m³/s)

K = hydraulic conductivity (ft/sec or m/s)

h = hydraulic head (ft or m)

A = cross-sectional area of flow (ft² or m²)

$$q = -K \frac{dh}{dx}$$

where

q = specific discharge (also called Darcy velocity or superficial velocity)

$$v = \frac{q}{n} = \frac{-K}{n} \frac{dh}{dx}$$

where

v = average seepage velocity

n = effective porosity

Unit hydrograph: The direct runoff hydrograph that would result from one unit of runoff occurring uniformly in space and time over a specified period of time.

Transmissivity, T: The product of hydraulic conductivity and thickness, b , of the aquifer (L^2T^{-1}).

Storativity or storage coefficient of an aquifer, S: The volume of water taken into or released from storage per unit surface area per unit change in potentiometric (piezometric) head.

Well Drawdown

Unconfined aquifer

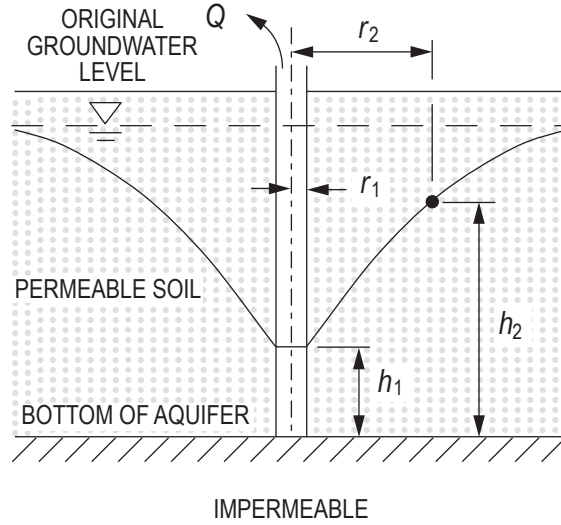

Dupuit's Formula

$$Q = \frac{\pi K (h_2^2 - h_1^2)}{\ln\left(\frac{r_2}{r_1}\right)}$$

where

- Q = flowrate of water drawn from well (cfs)
- K = coefficient of permeability of soil; hydraulic conductivity (ft/sec)
- h_1 = height of water surface above bottom of aquifer at perimeter of well (ft)
- h_2 = height of water surface above bottom of aquifer at distance r_2 from well centerline (ft)
- r_1 = radius to water surface at perimeter of well, i.e., radius of well (ft)
- r_2 = radius to water surface whose height is h_2 above bottom of aquifer (ft)
- ln = natural logarithm
- Q/D_w = specific capacity
- D_w = well drawdown (ft)

Confined aquifer

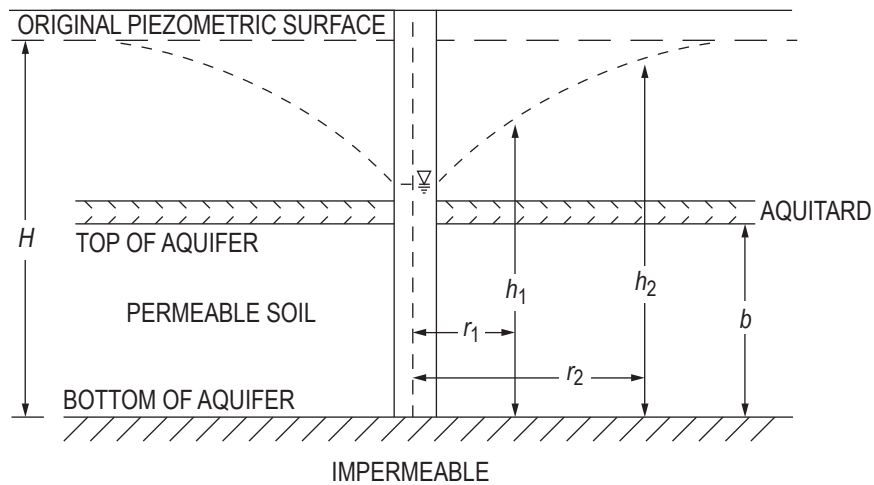

Theim Equation

$$Q = \frac{2\pi T(h_2 - h_1)}{\ln\left(\frac{r_2}{r_1}\right)}$$

where

- T = Kb = transmissivity (ft²/sec)
- b = thickness of confined aquifer (ft)
- h_1, h_2 = heights of piezometric surface above bottom of aquifer (ft)
- r_1, r_2 = radii from pumping well (ft)
- ln = natural logarithm
- H = height of peizometric surface prior to pumping (ft)

Sewage Flow Ratio Curves

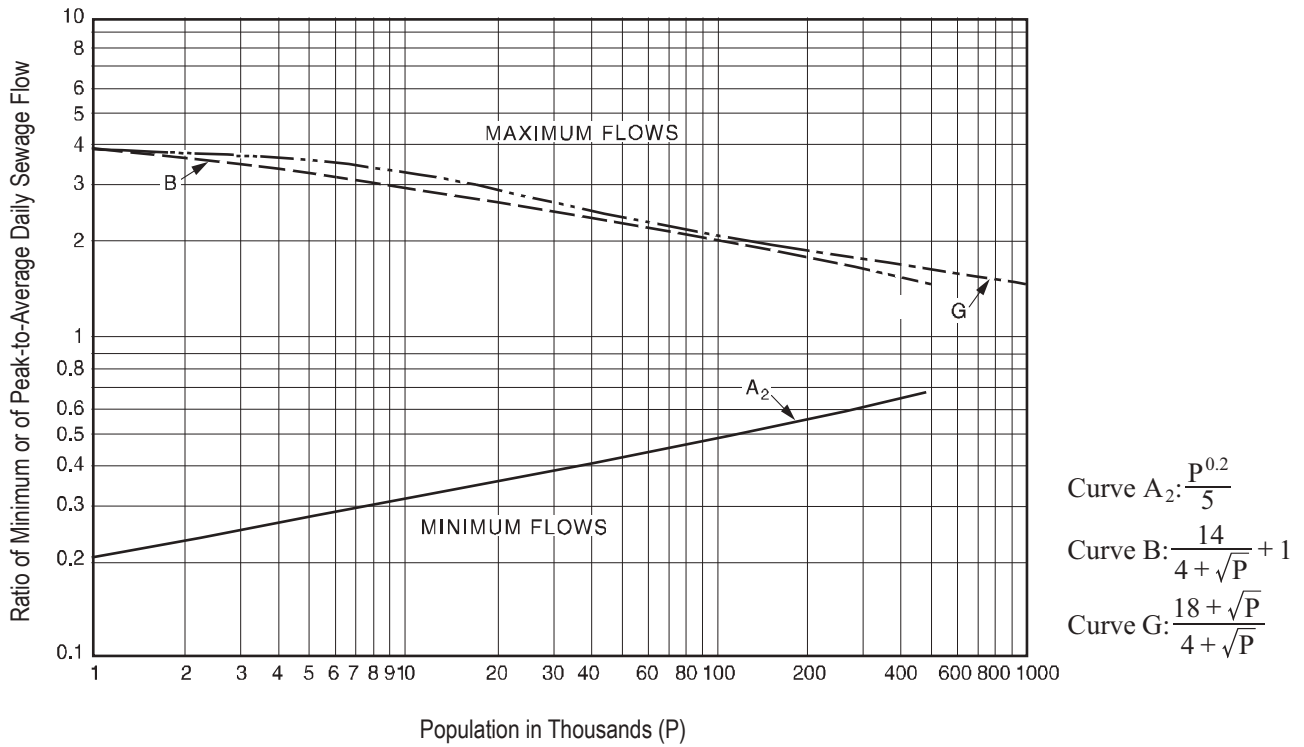

Design and Construction of Sanitary and Storm Sewers, Water Pollution Control Federation and American Society of Civil Engineers, 1970.

Reprinted with permission from ASCE.

This material may be downloaded from ncees.org for personal use only. Any other use requires prior permission of ASCE.

Hydraulic-Elements Graph for Circular Sewers

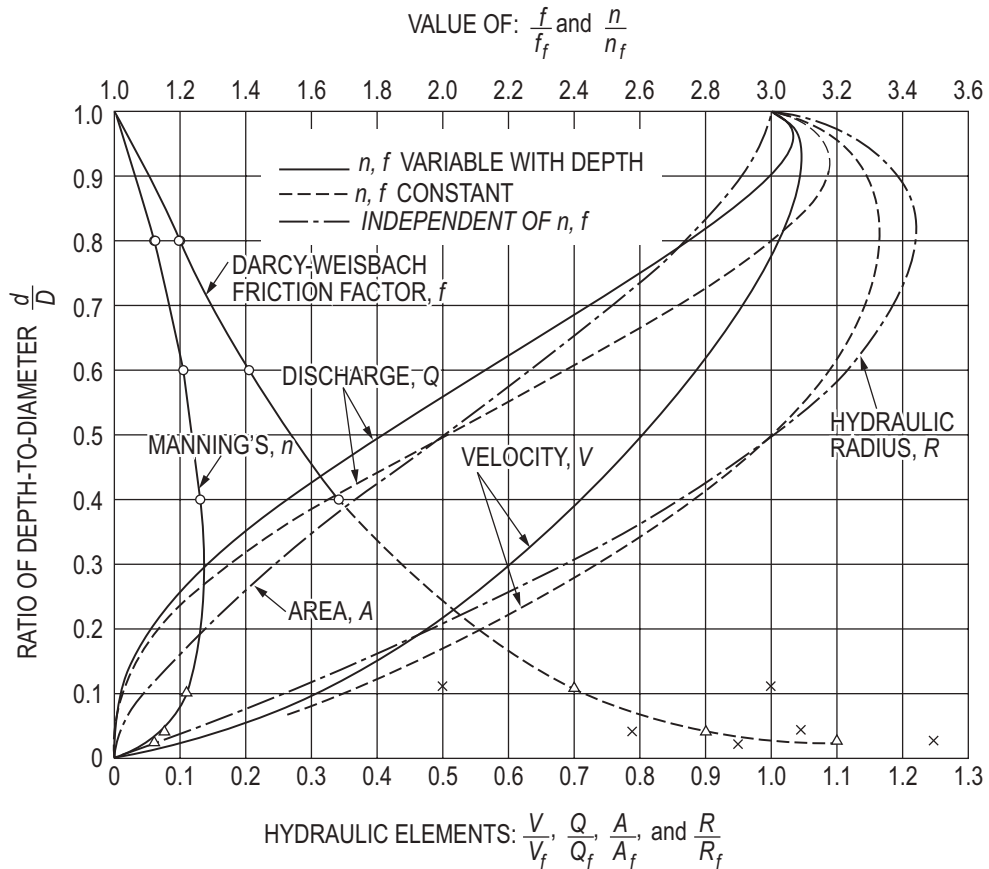

Design and Construction of Sanitary and Storm Sewers, Water Pollution Control Federation and American Society of Civil Engineers, 1970.

Reprinted with permission from ASCE.

This material may be downloaded from ncees.org for personal use only. Any other use requires prior permission of ASCE.

Open-Channel Flow

Specific Energy

$$E = \alpha \frac{V^2}{2g} + y = \frac{\alpha Q^2}{2gA^2} + y$$

where

E = specific energy

Q = discharge

V = velocity

y = depth of flow

A = cross-sectional area of flow

α = kinetic energy correction factor, usually 1.0

Critical Depth = that depth in a channel at minimum specific energy

$$\frac{Q^2}{g} = \frac{A^3}{T}$$

where Q and A are as defined above,

g = acceleration due to gravity

T = width of the water surface

For rectangular channels

$$y_c = \left(\frac{q^2}{g} \right)^{1/3}$$

where

y_c = critical depth

q = unit discharge = $\frac{Q}{B}$

B = channel width

g = acceleration due to gravity

Froude Number = ratio of inertial forces to gravity forces

$$Fr = \frac{V}{\sqrt{gy_h}} = \sqrt{\frac{Q^2 T}{gA^3}}$$

where y_h = hydraulic depth = $\frac{A}{T}$

Supercritical flow: $Fr > 1$

Subcritical flow: $Fr < 1$

Critical flow: $Fr = 1$

Specific Energy Diagram

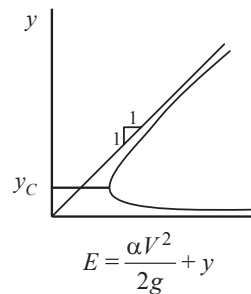

Alternate depths: depths with the same specific energy

Uniform flow: a flow condition where depth and velocity do not change along a channel

Momentum Depth Diagram

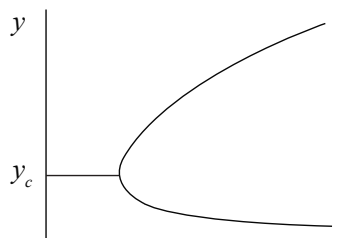

$$M = \frac{Q^2}{gA} + Ah_c$$

where h_c = vertical distance from liquid surface to centroid of area

Sequent (conjugate) depths: depths with the same momentum

Hydraulic Jump

$$y_2 = \frac{y_1}{2} \left(-1 + \sqrt{1 + 8Fr_1^2} \right)$$

where

y_1 = flow depth at upstream supercritical flow location

y_2 = flow depth at downstream subcritical flow location

Fr_1 = Froude number at upstream supercritical flow location

Manning's Equation

$$Q = \frac{K}{n} AR_H^{2/3} S^{1/2}$$

$$V = \frac{K}{n} R_H^{2/3} S^{1/2}$$

where

Q = discharge (ft³/sec or m³/s)

V = velocity (ft/sec or m/s)

K = 1.486 for USCS units, 1.0 for SI units

n = roughness coefficient

A = cross-sectional area of flow (ft² or m²)

R_H = hydraulic radius (ft or m) = $\frac{A}{P}$

P = wetted perimeter (ft or m)

S = slope (ft/ft or m/m)

Weir Formulas

Rectangular

Free discharge suppressed

$$Q = CLH^{3/2}$$

Free discharge contracted

$$Q = C(L - 0.2H)H^{3/2}$$

V-Notch

$$Q = CH^{5/2}$$

where

Q = discharge (ft³/sec or m³/s)

C = 3.33 for rectangular weir (USCS units)

C = 1.84 for rectangular weir (SI units)

C = 2.54 for 90° V-notch weir (USCS units)

C = 1.40 for 90° V-notch weir (SI units)

L = weir length (ft or m)

H = head (depth of discharge over weir) ft or m

Hazen-Williams Equation

$$V = k_1 CR_H^{0.63} S^{0.54}$$

where

$$Q = k_1 CAR_H^{0.63} S^{0.54}$$

where

C = roughness coefficient

k_1 = 0.849 for SI units

k_1 = 1.318 for USCS units

R_H = hydraulic radius (ft or m)

S = slope of energy grade line (ft/ft or m/m) = $\frac{h_f}{L}$

V = velocity (ft/sec or m/s)

Q = discharge (ft³/sec or m³/s)

Circular Pipe Head Loss Equation (Head Loss Expressed in Feet)

$$h_f = \frac{4.73 L}{C^{1.852} D^{4.87}} Q^{1.852}$$

where

h_f = head loss (ft)

L = pipe length (ft)

D = pipe diameter (ft)

Q = flow (cfs)

C = Hazen-Williams coefficient

Circular Pipe Head Loss Equation (Head Loss Expressed as Pressure)

U.S. Customary Units

$$P = \frac{4.52 Q^{1.85}}{C^{1.85} D^{4.87}}$$

where

P = pressure loss (psi per foot of pipe)

Q = flow (gpm)

D = pipe diameter (inches)

C = Hazen-Williams coefficient

SI Units

$$P = \frac{6.05 Q^{1.85}}{C^{1.85} D^{4.87}} \times 10^5$$

where

P = pressure loss (bars per meter of pipe)

Q = flow (liters/minute)

D = pipe diameter (mm)

Values of Hazen-Williams Coefficient C	
Pipe Material	C
Ductile iron	140
Concrete (regardless of age)	130
Cast iron:	
New	130
5 yr old	120
20 yr old	100
Welded steel, new	120
Wood stave (regardless of age)	120
Vitrified clay	110
Riveted steel, new	110
Brick sewers	100
Asbestos-cement	140
Plastic	150

Formula for Calculating Rated Capacity at 20 psi from Fire Hydrant

$$Q_R = Q_F \times (H_R/H_F)^{0.54}$$

where

Q_R = rated capacity (gpm) at 20 psi

Q_F = total test flow

$H_R = P_S - 20$ psi

$H_F = P_S - P_R$

P_S = static pressure

P_R = residual pressure

NFPA Standard 291, *Recommended Practice for Fire Flow Testing and Marking of Hydrants*, Section 4.10.1.2

Fire Hydrant Discharging to Atmosphere

$$Q = 29.8 D^2 C_d P^{1/2}$$

where

Q = discharge (gpm)

D = outlet diameter (in.)

P = pressure detected by pitot gauge (psi)

C_d = hydrant coefficient based on hydrant outlet geometry

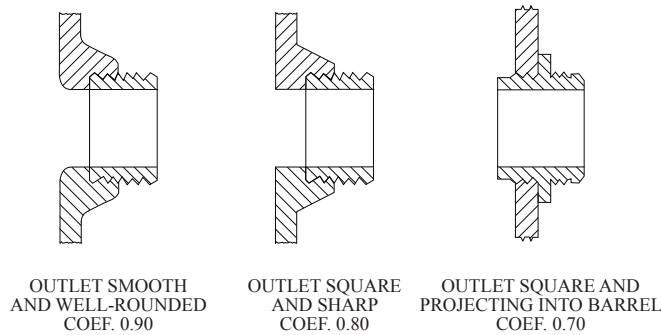

NFPA Standard 291, *Recommended Practice for Fire Flow Testing and Marking of Hydrants*, Section 4.10.1.2

Fire Sprinkler Discharge

$$Q = KP^{1/2}$$

where

Q = flow (gpm)

K = measure of the ease of getting water out of the orifice, related to size and shape of the orifice in units of gpm per (psi)^{1/2}

P = pressure (psi)

Sprinkler K Factors

Orifice Size	Name	K Factor
1/2"	Standard	5.6
17/32"	Large	8.0
5/8"	Extra large	11.2

Transportation

Queueing models are found in the Industrial Engineering section.

Traffic Signal Timing

$$y = t + \frac{v}{2a \pm 64.4 G}$$

$$r = \frac{W+l}{v}$$

$$G_p = 3.2 + \frac{L}{S_p} + 0.27N_{\text{ped}}$$

where

t = driver reaction time (sec)

v = vehicle approach speed (ft/sec)

W = width of intersection, curb-to-curb (ft)

l = length of vehicle (ft)

y = length of yellow interval to nearest 0.1 sec (sec)

r = length of red clearance interval to nearest 0.1 sec (sec)

G_p = minimum green time for pedestrians (sec)

L = crosswalk length (ft)

S_p = pedestrian speed (ft/sec), default 3.5 ft/sec

N_{ped} = number of pedestrian in interval

a = deceleration rate (ft/sec²)

$\pm G$ = percent grade divided by 100 (uphill grade "+")

Stopping Sight Distance

$$SSD = 1.47Vt + \frac{V^2}{30\left(\left(\frac{a}{32.2}\right) \pm G\right)}$$

$$ISD = 1.47 V_{\text{major}} t_g$$

where

a = deceleration rate (ft/sec²)

$\pm G$ = percent grade divided by 100 (uphill grade "+")

SSD = stopping sight distance (ft)

ISD = intersection sight distance (ft)

t = driver reaction time (sec)

t_g = time gap for vehicle entering roadway (sec)

V = design speed (mph)

V_{major} = design speed of major road (mph)

Peak Hour Factor

$$PHF = \frac{\text{Hourly Volume}}{\text{Hourly Flow Rate}} = \frac{V}{4 * V_{15}}$$

where

PHF = peak hour factor

V = hourly volume (veh/hr)

V_{15} = peak 15-min. volume (veh/15 min)

Vertical Curves

$$y = ax^2$$

$$A = |g_2 - g_1|$$

$$a = \frac{g_2 - g_1}{2L}$$

$$E = a\left(\frac{L}{2}\right)^2$$

$$r = \frac{g_2 - g_1}{L}$$

$$K = \frac{L}{A}$$

$$x_m = -\frac{g_1}{2a} = -\frac{g_1 L}{g_1 - g_2}$$

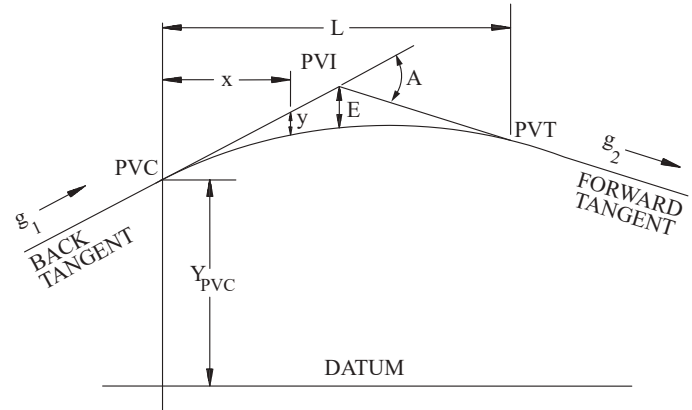

VERTICAL CURVE FORMULAS
NOT TO SCALE

Compiled from AASHTO, *A Policy on Geometric Design of Highways and Streets*, 6th ed., 2011.

$$\text{Tangent elevation} = Y_{PVC} + g_1 x = Y_{PVI} + g_2 (x - L/2)$$

$$\text{Curve elevation} = Y_{PVC} + g_1 x + ax^2 = Y_{PVC} + g_1 x + [(g_2 - g_1)/(2L)]x^2$$

where

PVC = point of vertical curvature, or beginning of curve

PVI = point of vertical intersection, or vertex

PVT = point of vertical tangency, or end of curve

A = algebraic difference in grades

a = parabola constant

E = tangent offset at PVI

g_1 = grade of back tangent

g_2 = grade of forward tangent

h_1 = height of driver's eyes above the roadway surface (ft)

h_2 = height of object above the roadway surface (ft)

K = rate of vertical curvature

L = length of curve

r = rate of change of grade

S = sight distance (ft)

x = horizontal distance from PVC to point on curve

x_m = horizontal distance to min/max elevation on curve

y = tangent offset

V = design speed (mph)

Vertical Curves: Sight Distance Related to Curve Length		
	$S \leq L$	$S > L$
Crest Vertical Curve General equation:	$L = \frac{AS^2}{100(\sqrt{2h_1} + \sqrt{2h_2})^2}$	$L = 2S - \frac{200(\sqrt{h_1} + \sqrt{h_2})^2}{A}$
Standard Criteria: $h_1 = 3.50$ ft and $h_2 = 2.0$ ft:	$L = \frac{AS^2}{2,158}$	$L = 2S - \frac{2,158}{A}$
Sag Vertical Curve (based on standard headlight criteria)	$L = \frac{AS^2}{400 + 3.5S}$	$L = 2S - \left(\frac{400 + 3.5S}{A}\right)$
Sag Vertical Curve (based on riding comfort)	$L = \frac{AV^2}{46.5}$	
Sag Vertical Curve (based on adequate sight distance under an overhead structure to see an object beyond a sag vertical curve)	$L = \frac{AS^2}{800\left(C - \frac{h_1 + h_2}{2}\right)}$	$L = 2S - \frac{800}{A}\left(C - \frac{h_1 + h_2}{2}\right)$
	$C =$ vertical clearance for overhead structure (overpass) located within 200 feet of the midpoint of the curve	

Compiled from AASHTO, *A Policy on Geometric Design of Highways and Streets*, 6th ed., 2011.

Horizontal Curves

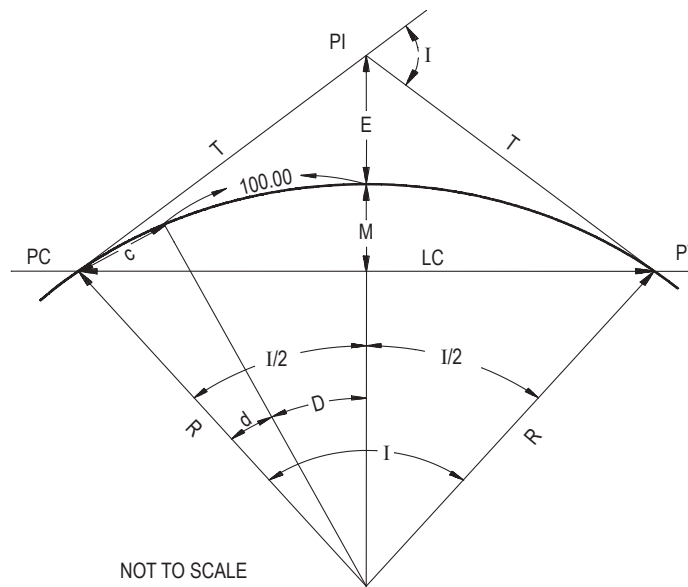

$$R = \frac{5729.58}{D}$$

$$R = \frac{LC}{2 \sin(I/2)}$$

$$T = R \tan(I/2) = \frac{LC}{2 \cos(I/2)}$$

$$L = RI \frac{\pi}{180} = \frac{I}{D} 100$$

$$M = R[1 - \cos(I/2)]$$

$$\frac{R}{E + R} = \cos(I/2)$$

$$\frac{R - M}{R} = \cos(I/2)$$

$$c = 2R \sin(d/2)$$

$$l = Rd\left(\frac{\pi}{180}\right)$$

$$E = R\left[\frac{1}{\cos(I/2)} - 1\right]$$

where

- c = length of sub-chord
- d = angle of sub-chord
- D = degree of curve, arc definition
- e = superelevation (%)
- E = external distance
- f = side friction factor
- I = intersection angle (also called Δ); angle between two tangents
- l = curve length for sub-chord
- L = length of curve, from PC to PT
- LC = length of long chord
- M = length of middle ordinate
- PC = point of curve (also called BC)
- PI = point of intersection
- PT = point of tangent (also called EC)
- R = radius
- S = sight distance (ft)
- T = tangent distance
- V = design speed (mph)

Horizontal Curves	
Side friction factor (based on superelevation)	$0.01e + f = \frac{V^2}{15R}$
Spiral Transition Length	$L_s = \frac{3.15V^3}{RC}$ <small>C = rate of increase of lateral acceleration [use 1 ft/sec³ unless otherwise stated]</small>
Sight Distance (to see around obstruction)	$HSO = R \left[1 - \cos\left(\frac{28.65S}{R}\right) \right]$ HSO = Horizontal sight line offset

Basic Freeway Segment Highway Capacity

Speed Flow Relationship for Basic Freeway Segments

FFS (mph)	Capacity (pc/h/ln)	Breakpoint (pc/h/ln)	> Breakpoint ≤ Capacity (mph)
75	2,400	1,000	$= 75 - 0.00001105 (v_p - 1,000)^2$
70	2,400	1,200	$= 70 - 0.00001157 (v_p - 1,200)^2$
65	2,350	1,400	$= 65 - 0.00001416 (v_p - 1,400)^2$
60	2,300	1,600	$= 60 - 0.00001814 (v_p - 1,600)^2$
55	2,250	1,800	$= 55 - 0.00002469 (v_p - 1,800)^2$

* All equations are based on Exhibit 12-6 and Equation 12-1 from the HCM 6th Edition assuming all calibration factors (CAF and SAF) set to 1.0

where

pc/h/ln = passenger cars per hour per lane

Level of Service (LOS)	Density (pc/mi/ln)
A	≤11
B	>11 – 18
C	>18 – 26
D	>26 – 35
E	>35 – 45
F	Demand exceeds capacity >45

$$FFS = BFFS - f_{LW} - f_{RLC} - 3.22 TRD^{0.84}$$

where

FFS = free flow speed of basic freeway segment (mph)

BFFS = base free flow speed of basic freeway segment (mph); default is 75.4 mph

f_{LW} = adjustment for lane width (mph)

f_{RLC} = adjustment for right-side lateral clearance (mph)

TRD = total ramp density (ramps/mi)

Average Lane Width (ft)	Reduction in FFS, f_{LW} (mph)
≥12	0.0
≥11 – 12	1.9
≥10 – 11	6.6

Right-Side Lateral Clearance (ft)	Lanes in One Direction			
	2	3	4	≥5
≥6	0.0	0.0	0.0	0.0
5	0.6	0.4	0.2	0.1
4	1.2	0.8	0.4	0.2
3	1.8	1.2	0.6	0.3
2	2.4	1.6	0.8	0.4
1	3.0	2.0	1.0	0.5
0	3.6	2.4	1.2	0.6

HCM: Highway Capacity Manual, 6th ed., A Guide for Multimodal Mobility Analysis, Transportation Research Board of the National Academies, Washington, DC, 2016.

$$v_p = \frac{V}{PHF \times N \times f_{HV}}$$

where

v_p = demand flowrate under equivalent base conditions (pc/h/ln)

V = demand volume under prevailing conditions (veh/h)

PHF = peak-hour factor

N = number of lanes in analysis direction

f_{HV} = adjustment factor for presence of heavy vehicles in traffic stream, calculated with

$$f_{HV} = \frac{1}{1 + P_T(E_T - 1)}$$

where

f_{HV} = heavy-vehicle adjustment factor

P_T = proportion of single unit trucks and tractor trailers in traffic stream

E_T = passenger-car equivalent (PCE) of single unit truck or tractor trailer in traffic stream

Vehicle	PCE by Type of Terrain	
	Level	Rolling
E_T	2.0	3.0

$$D = \frac{v_p}{S}$$

where

D = density(pc/mi/ln)

v_p = demand flow rate (pc/h/ln)

S = mean speed of traffic stream under base conditions (mph)

Traffic Flow Relationships

Greenshields Model

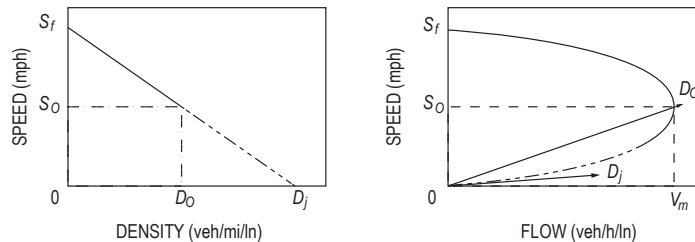

$$S = S_f - \frac{S_f}{D_j} D$$

$$V = S_f D - \frac{S_f}{D_j} D^2$$

$$V_m = \frac{D_j S_f}{4}$$

$$D_o = \frac{D_j}{2}$$

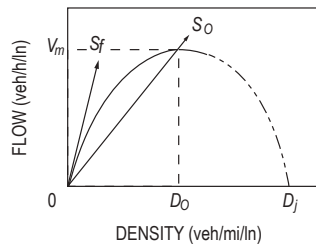

----- Oversaturated flow

AASHTO, *A Policy on Geometric Design of Highways and Streets*, 6th ed., 2011. Used by permission.

where

D = density (veh/mi)

S = speed (mph)

V = flow (veh/hr)

V_m = maximum flow (veh/hr)

D_o = optimum density (sometimes called critical density)

D_j = jam density (veh/hr)

S_o = optimum speed (often called critical speed) (mph)

S_f = theoretical speed selected by the first driver entering a facility (i.e., under zero density and zero flow rate conditions) (mph)

Gravity Model

$$T_{ij} = P_i \left[\frac{A_j F_{ij} K_{ij}}{\sum_j A_j F_{ij} K_{ij}} \right]$$

where

T_{ij} = number of trips that are produced in Zone i and attracted to Zone j

P_i = total number of trips produced in Zone i

A_j = number of trips attracted to Zone j

F_{ij} = friction factor that is an inverse function of travel time between Zones i and j

K_{ij} = socioeconomic adjustment factor for travel between Zones i and j

Logit Models

$$U_x = \sum_{i=1}^n a_i X_i$$

where

U_x = utility of Mode x

n = number of attributes

X_i = attribute value (time, cost, and so forth)

a_i = coefficient value for attributes i (negative, since the values are disutilities)

If two modes, auto (A) and transit (T), are being considered, the probability of selecting the auto Mode A can be written as

$$P(A) = \frac{e^{U_A}}{e^{U_A} + e^{U_T}}$$

If n modes of travel are being considered, the probability of selecting Mode x can be written as:

$$P(x) = \frac{e^{U_x}}{\sum_{x=1}^n e^{U_x}}$$

Traffic Safety Equations

Crash Rates at Intersections

$$RMEV = \frac{A \times 1,000,000}{V}$$

where

$RMEV$ = crash rate per million entering vehicles

A = number of crashes, total or by type occurring in a single year at the location

V = $ADT \times 365$

ADT = average daily traffic entering intersection

Crash Rates for Roadway Segments

$$RMVM = \frac{A \times 1,000,000}{VMT}$$

where

$RMVM$ = crash rate per million vehicle miles

A = number of crashes, total or by type at the study location, during a given period

VMT = vehicle miles of travel during the given period;

= $ADT \times (\text{number of days in study period}) \times (\text{length of road})$

ADT = average daily traffic on the roadway segment

Crash Reduction

$$\text{Crashes prevented} = N \times CR \frac{(ADT \text{ after improvement})}{(ADT \text{ before improvement})}$$

where

N = expected number of crashes if countermeasure is not implemented and if the traffic volume remains the same

$CR = CR_1 + (1 - CR_1)CR_2 + (1 - CR_1)(1 - CR_2)CR_3 + \dots + (1 - CR_1) \dots (1 - CR_{m-1}) CR_m$

overall crash reduction factor for multiple mutually exclusive improvements at a single site

CR_i = crash reduction factor for a specific countermeasure i

m = number of countermeasures at the site

Garber, Nicholas J., and Lester A. Hoel, *Traffic and Highway Engineering*, 4th ed., Cengage Learning, 2009.

Highway Pavement Design

AASHTO Structural Number Equation
$SN = a_1 D_1 + a_2 D_2 m_2 + a_3 D_3 m_3 + \dots + a_n D_n m_n$
where SN = structural number for the pavement a_i = layer coefficient D_i = thickness of layer (inches) m_i = drainage coefficient (assume m equals 1.0 unless otherwise given)

Gross Axle Load		Load Equivalency Factors		Gross Axle Load		Load Equivalency Factors	
kN	lb	Single Axles	Tandem Axles	kN	lb	Single Axles	Tandem Axles
4.45	1,000	0.00002		187.0	42,000	25.64	2.51
8.9	2,000	0.00018		195.7	44,000	31.00	3.00
17.8	4,000	0.00209		200.0	45,000	34.00	3.27
22.25	5,000	0.00500		204.5	46,000	37.24	3.55
26.7	6,000	0.01043		213.5	48,000	44.50	4.17
35.6	8,000	0.0343		222.4	50,000	52.88	4.86
44.5	10,000	0.0877	0.00688	231.3	52,000		5.63
53.4	12,000	0.189	0.0144	240.2	54,000		6.47
62.3	14,000	0.360	0.0270	244.6	55,000		6.93
66.7	15,000	0.478	0.0360	249.0	56,000		7.41
71.2	16,000	0.623	0.0472	258.0	58,000		8.45
80.0	18,000	1.000	0.0773	267.0	60,000		9.59
89.0	20,000	1.51	0.1206	275.8	62,000		10.84
97.8	22,000	2.18	0.180	284.5	64,000		12.22
106.8	24,000	3.03	0.260	289.0	65,000		12.96
111.2	25,000	3.53	0.308	293.5	66,000		13.73
115.6	26,000	4.09	0.364	302.5	68,000		15.38
124.5	28,000	5.39	0.495	311.5	70,000		17.19
133.5	30,000	6.97	0.658	320.0	72,000		19.16
142.3	32,000	8.88	0.857	329.0	74,000		21.32
151.2	34,000	11.18	1.095	333.5	75,000		22.47
155.7	35,000	12.50	1.23	338.0	76,000		23.66
160.0	36,000	13.93	1.38	347.0	78,000		26.22
169.0	38,000	17.20	1.70	356.0	80,000		28.99
178.0	40,000	21.08	2.08				

Note: kN converted to lb are within 0.1 percent of lb shown

Latitudes and Departures

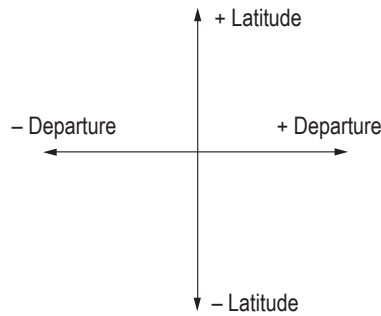

Earthwork formulas

Average End Area Formula

$$V = L(A_1 + A_2)/2$$

Prismoidal Formula

$$V = L (A_1 + 4A_m + A_2)/6$$

where

A_m = area of mid-section

L = distance between A_1 and A_2

Pyramid or Cone

$$V = h (\text{area of base})/3$$

Area formulas

Area by Coordinates: $\text{Area} = [X_A (Y_B - Y_N) + X_B (Y_C - Y_A) + X_C (Y_D - Y_B) + \dots + X_N (Y_A - Y_{N-1})] / 2$

Trapezoidal Rule: $\text{Area} = w \left(\frac{h_1 + h_n}{2} + h_2 + h_3 + h_4 + \dots + h_{n-1} \right)$ w = common interval

Simpson's 1/3 Rule: $\text{Area} = w \left[h_1 + 2 \left(\sum_{k=3,5,\dots}^{n-2} h_k \right) + 4 \left(\sum_{k=2,4,\dots}^{n-1} h_k \right) + h_n \right] / 3$ n must be odd number of measurements
(only for Simpson's 1/3 Rule)

Construction

Construction project scheduling and analysis questions may be based on either the activity-on-node method or the activity-on-arrow method.

CPM Precedence Relationships

ACTIVITY-ON-NODE

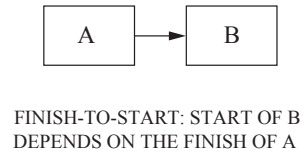
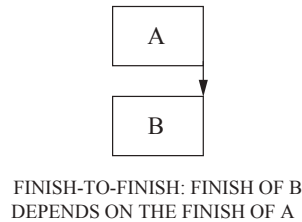
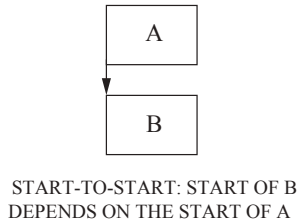

ACTIVITY-ON-ARROW ANNOTATION



ACTIVITY-ON-NODE ANNOTATION

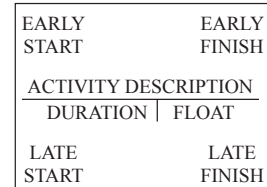

Nomenclature

- ES = Early start = Latest EF of predecessors
- EF = Early finish = $ES + \text{duration}$
- LS = Late start = $LF - \text{duration}$
- LF = Late finish = Earliest LS of successors
- D = Duration
- Float = $LS - ES$ or $LF - EF$

Earned-Value Analysis

- $BCWS$ = Budgeted cost of work scheduled (Planned)
- $ACWP$ = Actual cost of work performed (Actual)
- $BCWP$ = Budgeted cost of work performed (Earned)

Variances

- $CV = BCWP - ACWP$ (Cost variance = Earned – Actual)
- $SV = BCWP - BCWS$ (Schedule variance = Earned – Planned)

Indices

- $CPI = \frac{BCWP}{ACWP}$ (Cost Performance Index = $\frac{\text{Earned}}{\text{Actual}}$)
- $SPI = \frac{BCWP}{BCWS}$ (Schedule Performance Index = $\frac{\text{Earned}}{\text{Planned}}$)

Forecasting

- BAC = Original project estimate (Budget at completion)
- $ETC = \frac{BAC - BCWP}{CPI}$ (Estimate to complete)
- $EAC = (ACWP + ETC)$ (Estimate at completion)

Environmental Engineering

Air pollution

Nomenclature

$$\frac{\mu\text{g}}{\text{m}^3} = \text{ppb} \times \frac{P(\text{MW})}{RT}$$

where

ppb = parts per billion

P = pressure (atm)

R = ideal gas law constant
= 0.0821 L·atm/(mole·K)

T = absolute temperature (K)
= 273.15 + °C

MW = molecular weight (g/mole)

Atmospheric Dispersion Modeling (Gaussian)

σ_y and σ_z as a function of downwind distance and stability class, see following figures.

$$C = \frac{Q}{2\pi u \sigma_y \sigma_z} \exp\left(-\frac{1}{2} \frac{y^2}{\sigma_y^2}\right) \left[\exp\left(-\frac{1}{2} \frac{(z-H)^2}{\sigma_z^2}\right) + \exp\left(-\frac{1}{2} \frac{(z+H)^2}{\sigma_z^2}\right) \right]$$

where

C = steady-state concentration at a point (x, y, z) ($\mu\text{g}/\text{m}^3$)

Q = emissions rate ($\mu\text{g}/\text{s}$)

σ_y = horizontal dispersion parameter (m)

σ_z = vertical dispersion parameter (m)

u = average wind speed at stack height (m/s)

y = horizontal distance from plume centerline (m)

z = vertical distance from ground level (m)

H = effective stack height (m) = $h + \Delta h$

where

h = physical stack height

Δh = plume rise

x = downwind distance along plume centerline (m)

Maximum concentration at ground level and directly downwind from an elevated source.

$$C_{\text{max}} = \frac{Q}{\pi u \sigma_y \sigma_z} \exp\left(-\frac{1}{2} \frac{(H^2)}{\sigma_z^2}\right)$$

where variables are as above except

C_{max} = maximum ground-level concentration

$\sigma_z = \frac{H}{\sqrt{2}}$ for neutral atmospheric conditions

Selected Properties of Air

Nitrogen (N ₂) by volume	78.09%
Oxygen (O ₂) by volume	20.94%
Argon (Ar) by volume	0.93%
Molecular weight of air	28.966 g/mol
Absolute viscosity, μ	
at 80°F	0.045 lbm/(hr-ft)
at 100°F	0.047 lbm/(hr-ft)
Density	
at 80°F	0.0734 lbm/ft ³
at 100°F	0.0708 lbm/ft ³

The dry adiabatic lapse rate Γ_{AD} is 0.98°C per 100 m (5.4°F per 1,000 ft). This is the rate at which dry air cools adiabatically with altitude.

$$\text{Lapse rate} = \Gamma = -\frac{\Delta T}{\Delta z}$$

where

ΔT = change in temperature

Δz = change in elevation

The actual (environmental) lapse rate Γ is compared to Γ_{AD} to determine stability as follows:

Lapse Rate	Stability Condition
$\Gamma > \Gamma_{AD}$	Unstable
$\Gamma = \Gamma_{AD}$	Neutral
$\Gamma < \Gamma_{AD}$	Stable

Atmospheric Stability Under Various Conditions

Surface Wind Speed ^a (m/s)	Day Solar Insolation			Night Cloudiness ^c	
	Strong ^b	Moderate ^c	Slight ^d	Cloudy	Clear
				(≥4/8)	(≤3/8)
<2	A	A-B ^f	B	E	F
2-3	A-B	B	C	E	F
3-5	B	B-C	C	D	E
5-6	C	C-D	D	D	D
>6	C	D	D	D	D

Notes:

- a. Surface wind speed is measured at 10 m above the ground.
 - b. Corresponds to clear summer day with sun higher than 60° above the horizon.
 - c. Corresponds to a summer day with a few broken clouds, or a clear day with sun 35-60° above the horizon.
 - d. Corresponds to a fall afternoon, or a cloudy summer day, or clear summer day with the sun 15-35°.
 - e. Cloudiness is defined as the fraction of sky covered by the clouds.
 - f. For A-B, B-C, or C-D conditions, average the values obtained for each.
- * A = Very unstable D = Neutral
 B = Moderately unstable E = Slightly stable
 C = Slightly unstable F = Stable

Regardless of wind speed, Class D should be assumed for overcast conditions, day or night.

Turner, D.B., "Workbook of Atmospheric Dispersion Estimates: An Introduction to Dispersion Modeling," 2nd ed., Lewis Publishing/CRC Press, Florida, 1994.

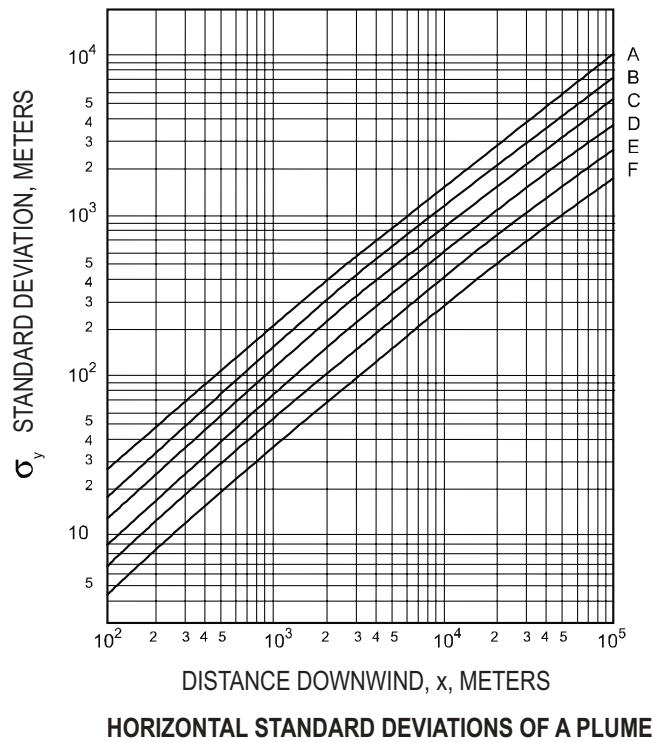
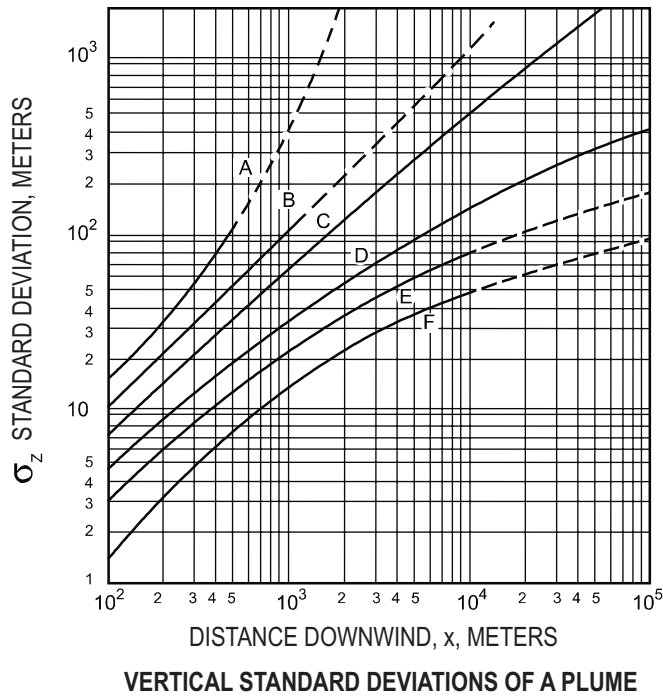

- A – EXTREMELY UNSTABLE
- B – MODERATELY UNSTABLE
- C – SLIGHTLY UNSTABLE
- D – NEUTRAL
- E – SLIGHTLY STABLE
- F – MODERATELY STABLE

Downwind distance where the maximum concentration occurs, x_{\max} , versus $(Cu/Q)_{\max}$ as a function of stability class

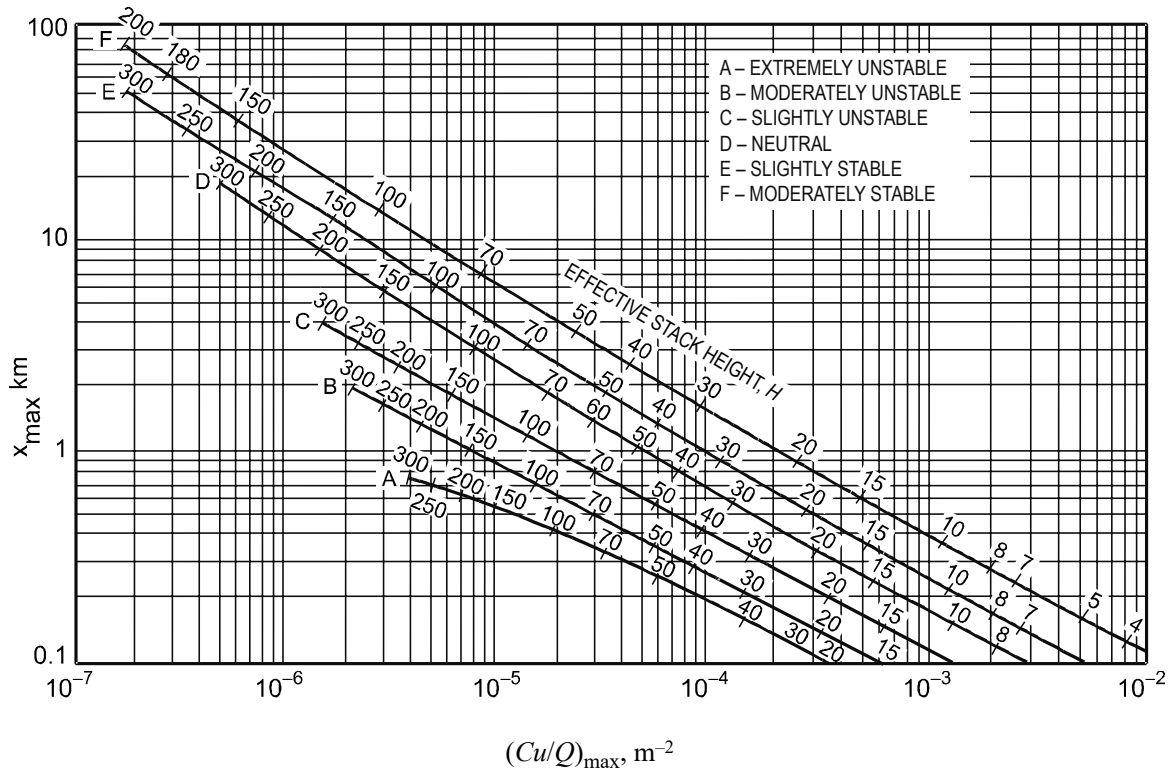

NOTES: Effective stack height shown on curves numerically.

x_{\max} = distance along plume centerline to the point of maximum concentration

$$(Cu/Q)_{\max} = e^{[a + b \ln H + c (\ln H)^2 + d (\ln H)^3]}$$

H = effective stack height = stack height + plume rise (m)

Turner, D.B., "Workbook of Atmospheric Dispersion Estimates: An Introduction to Dispersion Modeling," 2nd ed., Lewis Publishing/CRC Press, Florida, 1994.

Values of Curve-Fit Constants for Estimating $(Cu/Q)_{\max}$ from H as a Function of Atmospheric Stability

Stability	Constants			
	a	b	c	d
A	-1.0563	-2.7153	0.1261	0
B	-1.8060	-2.1912	0.0389	0
C	-1.9748	-1.9980	0	0
D	-2.5302	-1.5610	-0.0934	0
E	-1.4496	-2.5910	0.2181	-0.0343
F	-1.0488	-3.2252	0.4977	-0.0765

Adapted from Ranchoux, R.J.P., 1976.

Turner, D.B., "Workbook of Atmospheric Dispersion Estimates: An Introduction to Dispersion Modeling," 2nd ed., Lewis Publishing/CRC Press, Florida, 1994.

Cyclone

Cyclone Collection (Particle Removal) Efficiency

$$\eta = \frac{1}{1 + (d_{pc}/d_p)^2}$$

where

d_{pc} = diameter of particle collected with 50% efficiency

d_p = diameter of particle of interest

η = fractional particle collection efficiency

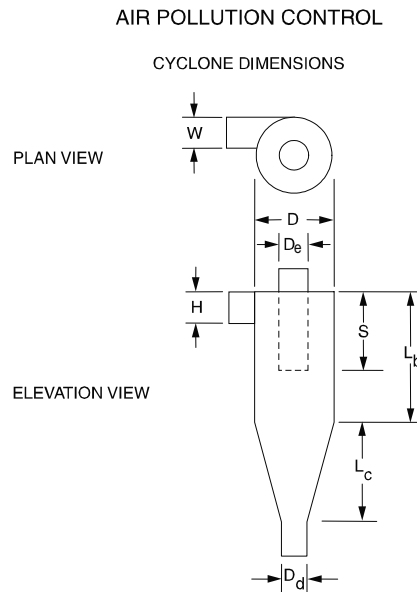

Adapted from Cooper, David C., and F.C. Alley, *Air Pollution Control: A Design Approach*, 2nd ed., Waveland Press, Illinois, 1986.

Cyclone Effective Number of Turns Approximation

$$N_e = \frac{1}{H} \left[L_b + \frac{L_c}{2} \right]$$

where

N_e = number of effective turns gas makes in cyclone

H = inlet height of cyclone (m)

L_b = length of body cyclone (m)

L_c = length of cone of cyclone (m)

Cyclone Ratio of Dimensions to Body Diameter

Dimension	High Efficiency	Conventional	High Throughput
Inlet height, H	0.44	0.50	0.80
Inlet width, W	0.21	0.25	0.35
Body length, L_b	1.40	1.75	1.70
Cone length, L_c	2.50	2.00	2.00
Vortex finder length, S	0.50	0.60	0.85
Gas exit diameter, D_e	0.40	0.50	0.75
Dust outlet diameter, D_d	0.40	0.40	0.40

Adapted from Cooper, David C., and F.C. Alley, *Air Pollution Control: A Design Approach*, 2nd ed., Waveland Press, Illinois, 1986.

Cyclone 50% Collection Efficiency for Particle Diameter

$$d_{pc} = \left[\frac{9\mu W}{2\pi N_e V_i (\rho_p - \rho_g)} \right]^{0.5}$$

where

d_{pc} = diameter of particle that is collected with 50% efficiency (m)

μ = dynamic viscosity of gas (kg/m•s)

W = inlet width of cyclone (m)

N_e = number of effective turns gas makes in cyclone

V_i = inlet velocity into cyclone (m/s)

ρ_p = density of particle (kg/m³)

ρ_g = density of gas (kg/m³)

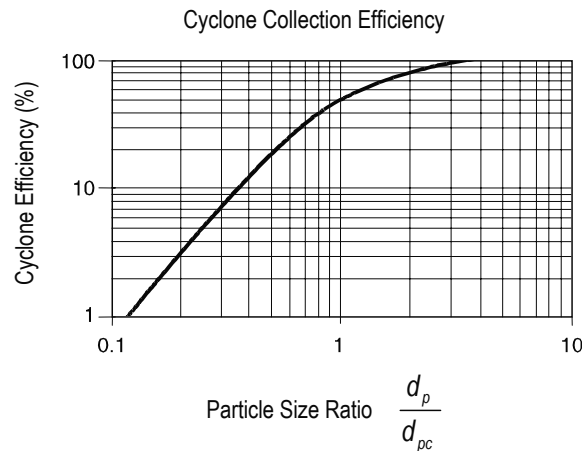

Adapted from Cooper, David C., and F.C. Alley, *Air Pollution Control: A Design Approach*, 2nd ed., Waveland Press, Illinois, 1986.

Baghouse

Air-to-Cloth Ratio for Baghouses

Dust	Shaker/Woven	
	Reverse Air/Woven [m ³ /(min•m ²)]	Pulse Jet/Felt [m ³ /(min•m ²)]
alumina	0.8	2.4
asbestos	0.9	3.0
bauxite	0.8	2.4
carbon black	0.5	1.5
coal	0.8	2.4
cocoa	0.8	3.7
clay	0.8	2.7
cement	0.6	2.4
cosmetics	0.5	3.0
enamel frit	0.8	2.7
feeds, grain	1.1	4.3
feldspar	0.7	2.7
fertilizer	0.9	2.4
flour	0.9	3.7
fly ash	0.8	1.5
graphite	0.6	1.5
gypsum	0.6	3.0
iron ore	0.9	3.4
iron oxide	0.8	2.1
iron sulfate	0.6	1.8
lead oxide	0.6	1.8
leather dust	1.1	3.7
lime	0.8	3.0
limestone	0.8	2.4
mica	0.8	2.7
paint pigments	0.8	2.1
paper	1.1	3.0
plastics	0.8	2.1
quartz	0.9	2.7
rock dust	0.9	2.7
sand	0.8	3.0
sawdust (wood)	1.1	3.7
silica	0.8	2.1
slate	1.1	3.7
soap detergents	0.6	1.5
spices	0.8	3.0
starch	0.9	2.4
sugar	0.6	2.1
talc	0.8	3.0
tobacco	1.1	4.0

U.S. EPA OAQPS Control Cost Manual, 4th ed., EPA 450/3-90-006 (NTIS PB 90-169954), January 1990.

Electrostatic Precipitator Efficiency

Deutsch-Anderson equation:

$$\eta = 1 - e^{(-WA/Q)}$$

where

η = fractional collection efficiency

W = terminal drift velocity

A = total collection area

Q = volumetric gas flowrate

Note that any consistent set of units can be used for W , A , and Q (e.g., ft/min, ft², and ft³/min).

Incineration

$$DRE = \frac{W_{in} - W_{out}}{W_{in}} \times 100\%$$

where

DRE = destruction and removal efficiency (%)

W_{in} = mass feed rate of a particular POHC (kg/h or lb/h)

W_{out} = mass emission rate of the same POHC (kg/h or lb/h)

POHC = principal organic hazardous contaminant

$$CE = \frac{CO_2}{CO_2 + CO} \times 100\%$$

where

CO_2 = volume concentration (dry) of CO_2 (parts per million; volume, ppm_v)

CO = volume concentration (dry) of CO (ppm_v)

CE = combustion efficiency

Kiln Formula

$$t = \frac{2.28 L/D}{SN}$$

where

t = mean residence time (min)

L/D = internal length-to-diameter ratio

S = kiln rake slope (in./ft of length)

N = rotational speed (rev/min)

Energy Content of Waste

Typical Waste Values	Moisture, %	Energy, Btu/lb
Food Waste	70	2,000
Paper	6	7,200
Cardboard	5	7,000
Plastics	2	14,000
Wood	20	8,000
Glass	2	60
Bi-metallic Cans	3	300

Indoor Air Quality

Material Balance

$$V \frac{dC_i}{dt} = QC_o + S - QC_i - kC_iV$$

where

V = volume of the room (m^3)

C_i = indoor concentration of this pollutant ($\frac{\mu g}{m^3}$)

C_o = concentration of the pollutant in the outside air ($\frac{\mu g}{m^3}$)

Q = ventilation rate ($\frac{m^3}{hr}$)

S = source emission rate inside the room ($\frac{\mu g}{hr}$)

k = removal reaction rate constant (assumed here to be first order) (hr^{-1})

C_i = indoor concentration of pollutant = $C_{i,ss}(1 - e^{-t/\tau}) + C_o e^{-t/\tau}$

where

$C_{i,ss}$ = steady state concentration of indoor pollutant = $\tau \left(AC_o + \frac{S}{V} \right)$

τ = time constant = $(A + k)^{-1}$

A = air exchange rate = $\frac{Q}{V}$, air changes per hour (ach)

Air Infiltration Rates into Homes with Windows Closed

Layout of Room	Air Exchange Rate (air changes per hour, ach)
No windows or exterior doors	0.5
Windows or exterior doors on one wall	1.0
Windows or exterior doors on two walls	1.5
Windows or exterior doors on three walls	2.0

Approximate Volume Flow Rate of Outdoor Air

$$Q_{OA} \approx \frac{13,000 n}{C_{indoors} - C_{OA}}$$

where

Q_{OA} = approximate volume flow rate of outdoor air (cfm)

n = number of people working in an office complex

$C_{indoors}$ = measured concentration of tracer gas (e.g., CO_2) in the space after a long period of time (e.g., 4 or more hours) of human occupation (ppm)

C_{OA} = concentration of the tracer gas (e.g., CO_2) in the outdoor air (ppm)

Percent of Outdoor Air

$$\% \text{ Outdoor Air} = \frac{C_{RA} - C_{SA}}{C_{RA} - C_{OA}} \times 100$$

where

- C_{RA} = CO₂ concentration in return air
- C_{SA} = CO₂ concentration in supply air
- C_{OA} = CO₂ concentration in outdoor air

Outdoor Air Changes per Hour

$$N = \frac{\ln(C_i - C_o) - \ln(C_a - C_o)}{h}$$

where

- N = air changes per hour of outdoor air
- C_i = concentration of CO₂ at start of test
- C_o = outdoor concentration of CO₂
- C_a = concentration of CO₂ at end of test
- h = time elapse between start and end of test (hour)

Fate and Transport

Mass Calculations

$$\text{Mass balance: } \frac{dM}{dt} = \frac{dM_{in}}{dt} + \frac{dM_{out}}{dt} \pm r$$

$$M = CQ = CV$$

$$\text{Continuity equation} = Q = vA$$

where

- M = mass
- M_{in} = mass in
- M_{out} = mass out
- r = reaction rate = kC^n
- k = reaction rate constant $\left(\frac{1}{(\text{concentration units})^{n-1} \cdot \text{time}} \right)$
- n = order of reaction
- C = concentration (mass/volume)
- Q = flowrate
- V = volume
- v = velocity
- A = cross-sectional area of flow

$$M (\text{lb/day}) = C (\text{mg/L}) \times Q (\text{MGD}) \times 8.34 [\text{lb-L}/(\text{mg-MG})]$$

where

- MGD = million gallons per day
- MG = million gallons

Microbial Kinetics

BOD Exertion

$$\text{BOD}_t = L_o(1 - e^{-kt})$$

where

k = BOD decay rate constant (base e, days⁻¹)

L_o = ultimate BOD (mg/L)

t = time (days)

BOD_t = the amount of BOD exerted at time t (mg/L)

Stream Modeling

Streeter Phelps

$$D = \frac{k_d L_a}{k_r - k_d} [\exp(-k_d t) - \exp(-k_r t)] + D_a \exp(-k_r t)$$

$$t_c = \frac{1}{k_r - k_d} \ln \left[\frac{k_r}{k_d} \left(1 - D_a \frac{(k_r - k_d)}{k_d L_a} \right) \right]$$

$$DO = DO_{\text{sat}} - D$$

where

D = dissolved oxygen deficit (mg/L)

DO = dissolved oxygen concentration (mg/L)

D_a = initial dissolved oxygen deficit in mixing zone (mg/L)

DO_{sat} = saturated dissolved oxygen concentration (mg/L)

k_d = deoxygenation rate constant, base e (days⁻¹)

k_r = reaeration rate constant, base e (days⁻¹)

L_a = initial ultimate BOD in mixing zone (mg/L)

t = time (days)

t_c = time at which minimum dissolved oxygen occurs (days)

Davis, MacKenzie and David Cornwell, *Introduction to Environmental Engineering*, 4th ed., New York: McGraw-Hill, 2008.

Monod Kinetics—Substrate Limited Growth

Continuous flow systems where growth is limited by one substrate (chemostat):

$$\mu = \frac{Y k_m S}{K_s + S} - k_d = \mu_{\text{max}} \frac{S}{K_s + S} - k_d$$

Multiple Limiting Substrates

$$\frac{\mu}{\mu_{\text{max}}} = [\mu_1(S_1)][\mu_2(S_2)][\mu_3(S_3)] \dots [\mu_n(S_n)]$$

$$\text{where } \mu_i = \frac{S_i}{K_{s_i} + S_i} \text{ for } i = 1 \text{ to } n$$

Non-steady State Continuous Flow

$$\frac{dx}{dt} = Dx_0 + (\mu - k_d - D)x$$

Steady State Continuous Flow

$$\mu = D \text{ with } k_d \ll \mu$$

Product production at steady state, single substrate limiting

$$X_1 = Y_{P/S}(S_0 - S_i)$$

where

- k_d = microbial death rate or endogenous decay rate constant (time⁻¹)
- k_m = maximum growth rate constant (time⁻¹)
- K_s = saturation constant or half-velocity constant = concentration at $\mu_{\max}/2$
- S = concentration of substrate in solution (mass/unit volume)
- Y = yield coefficient [(mass/L product)/(mass/L food used)]
- μ = specific growth rate (time⁻¹)
- μ_{\max} = maximum specific growth rate (time⁻¹) = Yk_m

Kinetic Temperature Corrections

$$k_T = k_{20} (\theta)^{T-20}$$

- BOD (k): $\theta = 1.135$ (T = 4–20°C)
- $\theta = 1.056$ (T = 21–30°C)

- Reaeration (k_r) $\theta = 1.024$
- Bio Towers $\theta = 1.035$
- Trickling Filters $\theta = 1.072$

Monod growth rate constant as a function of limiting food concentration.

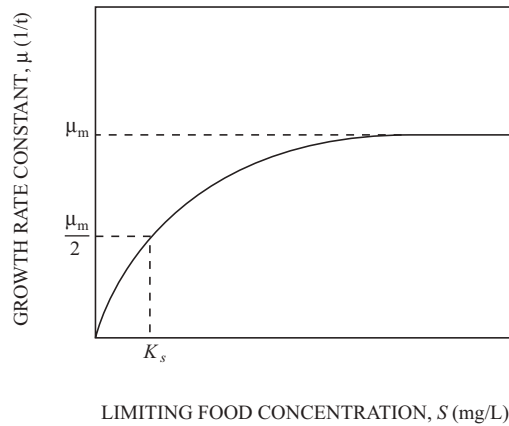

where

- X_1 = product (mg/L)
- V_r = volume (L)
- D = dilution rate (flow f / reactor volume V_r ; hr⁻¹)
- f = flowrate (L/hr)
- μ_i = growth rate with one or multiple limiting substrates (hr⁻¹)
- S_i = substrate i concentration (mass/unit volume)
- S_0 = initial substrate concentration (mass/unit volume)
- $Y_{P/S}$ = product yield per unit of substrate (mass/mass)
- p = product concentration (mass/unit volume)
- x = cell concentration (mass/unit volume)
- x_0 = initial cell concentration (mass/unit volume)
- t = time (time)

Davis, M.L., and D. Cornwell, *Introduction to Environmental Engineering*, 3rd ed., New York: McGraw-Hill, 1998.

Partition Coefficients

Bioconcentration Factor BCF

The amount of a chemical to accumulate in aquatic organisms.

$$BCF = C_{\text{org}}/C$$

where

C_{org} = equilibrium concentration in organism (mg/kg or ppm)

C = concentration in water (ppm)

Davis, M.L., and D. Cornwell, *Introduction to Environmental Engineering*, 3rd ed., McGraw-Hill, 1998.

Octanol-Water Partition Coefficient

The ratio of a chemical's concentration in the octanol phase to its concentration in the aqueous phase of a two-phase octanol-water system.

$$K_{ow} = C_o/C_w$$

where

C_o = concentration of chemical in octanol phase (mg/L or $\mu\text{g/L}$)

C_w = concentration of chemical in aqueous phase (mg/L or $\mu\text{g/L}$)

Davis, M.L., and D. Cornwell, *Introduction to Environmental Engineering*, 3rd ed., McGraw-Hill, 1998.

Organic Carbon Partition Coefficient K_{oc}

$$K_{oc} = C_{\text{soil}}/C_{\text{water}}$$

where

C_{soil} = concentration of chemical in organic carbon component of soil ($\mu\text{g adsorbed/kg organic C}$, or ppb)

C_{water} = concentration of chemical in water (ppb or $\mu\text{g/kg}$)

Davis, M.L., and D. Cornwell, *Introduction to Environmental Engineering*, 3rd ed., McGraw-Hill, 1998.

Retardation Factor R

$$R = 1 + (\rho_b/n_e)K_d$$

where

ρ_b = bulk density (mass/length³)

n_e = effective porosity of the media at saturation

K_d = partition or distribution coefficient

$$= K_{oc}f_{oc}$$

USEPA 402-R-99-004B, 1999, Understanding variations in partition coefficient, K_d , values.

Soil-Water Partition Coefficient $K_{sw} = K_p$

$$K_{sw} = X/C$$

where

X = concentration of chemical in soil (ppb or $\mu\text{g/kg}$)

C = concentration of chemical in water (ppb or $\mu\text{g/kg}$)

$$K_{sw} = K_{oc}f_{oc}$$

where

K_p = partition coefficient

f_{oc} = fraction of organic carbon in the soil (dimensionless)

LaGrega, Michael D., et al, *Hazardous Waste Management*, 2nd ed, McGraw-Hill, 2001.

Vadose Zone Penetration

$$D = \frac{RvV}{A}$$

where

D = maximum depth of penetration (m)

V = volume of infiltrating hydrocarbon (m³)

A = area of spill (m²)

Rv = a constant reflecting the retention capacity of the soil and the viscosity of the product (see following table)

Typical Values of Rv

Soil	Rv^{\dagger}		
	Gasoline	Kerosene	Light Fuel Oil
Coarse Gravel	400	200	100
Gravel to Coarse Sand	250	125	62
Coarse to Medium Sand	130	66	33
Medium to Fine Sand	80	40	20
Fine Sand to Silt	50	25	12
† A constant value representing capacity of soil and viscosity of product			

Data from Shepherd, W. D. No date. *Practical Geohydrological Aspects of Groundwater Contamination*. Dept. of Environmental Affairs, Houston: Shell Oil, as published in *Underground Storage Tank Corrective Action Technologies*, U.S. Environmental Protection Agency, 1987, pp. 3-8 and 3-9, epa.gov.

Steady-State Reactor Parameters (Constant Density Systems)

Comparison of Steady-State Retention Times (θ) for Decay Reactions of Different Order ^a

Reaction Order	r	Equations for Mean Retention Times (θ)		
		Ideal Batch	Ideal Plug Flow	Ideal CMFR
Zero ^b	$-k$	$\frac{(C_o - C_t)}{k}$	$\frac{(C_o - C_t)}{k}$	$\frac{(C_o - C_t)}{k}$
First	$-kC$	$\frac{\ln(C_o/C_t)}{k}$	$\frac{\ln(C_o/C_t)}{k}$	$\frac{(C_o/C_t) - 1}{k}$
Second	$-kC^2$	$\frac{(C_o/C_t) - 1}{kC_o}$	$\frac{(C_o/C_t) - 1}{kC_o}$	$\frac{(C_o/C_t) - 1}{kC_t}$

^a C_o = initial concentration or influent concentration; C_t = final condition or effluent concentration.

^bExpressions are valid for $k\theta \leq C_o$; otherwise $C_t = 0$.

Comparison of Steady-State Performance for Decay Reactions of Different Order ^a

Reaction Order	r	Equations for C_t		
		Ideal Batch	Ideal Plug Flow	Ideal CMFR
Zero ^b $t \leq C_o/k$	$-k$	$C_o - kt$	$C_o - k\theta$	$C_o - k\theta$
$t > C_o/k$		0		
First	$-kC$	$C_o[\exp(-kt)]$	$C_o[\exp(-k\theta)]$	$\frac{C_o}{1 + k\theta}$
Second	$-kC^2$	$\frac{C_o}{1 + ktC_o}$	$\frac{C_o}{1 + k\theta C_o}$	$\frac{(4k\theta C_o + 1)^{1/2} - 1}{2k\theta}$

^a C_o = initial concentration or influent concentration; C_t = final condition or effluent concentration.

^bTime conditions are for ideal batch reactor only.

Davis, M.L., and S.J. Masten, *Principles of Environmental Engineering and Science*, 2nd ed., McGraw-Hill, 2004.

Landfill

Typical Densities of As-Received Source-Separated Materials

Material	Typical density, lb/yd ³	Baled density,* lb/yd ³
Paper		
Newspaper	475	950
Corrugated cardboard	350	800
High grades	300–400	
Glass—whole bottles		
Clear	500	
Green or amber	550	
Glass—crushed		
Semicrushed	1,000	
1 1/2-in. mechanically crushed	1,800	
1/4-in. furnace ready	2,700	
Aluminum Cans		
Whole	50	950
Flattened	175	
Tin plated steel cans ("tin cans")		
Whole	150	1,400
Flattened	850	
Plastics		
PET, whole	34	750
PET, flattened	75	
HDPE (natural), whole	30	
HDPE (natural), flattened	65	
HDPE (colored), whole	45	
HDPE (colored), flattened	90	

*Based on bale size of 45 × 30 × 62 in.

Tchobanoglous, George, and Frank Kreith, *Handbook of Solid Waste Management*, 2nd ed., New York: McGraw-Hill, 2002, p. 8.68.

**Typical Moisture Content of Municipal
Solid Waste (MSW) Components**

Component	Moisture, percent	
	Range	Typical
Food wastes	50–80	70
Paper	4–10	6
Cardboard	4–8	5
Plastics	1–4	2
Textiles	6–15	10
Rubber	1–4	2
Leather	8–12	10
Garden trimmings	30–80	60
Wood	15–40	20
Glass	1–4	2
Tin cans	2–4	3
Nonferrous metals	2–4	2
Ferrous metals	2–6	3
Dirt, ashes, brick, etc.	6–12	8
Municipal solid waste	15–40	20

Tchobanoglous, George, Hilary Theisen, and Rolf Eliassen, *Solid Wastes: Engineering Principles and Management Issues*, New York: McGraw-Hill, 1977.

Break-Through Time for Leachate to Penetrate a Clay Liner

$$t = \frac{d^2 \eta}{K(d + h)}$$

where

- t = breakthrough time (yr)
- d = thickness of clay liner (ft)
- η = porosity
- K = hydraulic conductivity (ft/yr)
- h = hydraulic head (ft)

Typical porosity values for clays with a coefficient of permeability in the range of 10^{-6} to 10^{-8} cm/s vary from 0.1 to 0.3.

Effect of Overburden Pressure

$$SW_p = SW_i + \frac{p}{a + bp}$$

where

- SW_p = specific weight of the waste material at pressure p (lb/yd³) (typical 1,750 to 2,150)
- SW_i = initial compacted specific weight of waste (lb/yd³) (typical 1,000)
- p = overburden pressure (lb/in²)
- a = empirical constant (yd³/in²)
- b = empirical constant (yd³/lb)

Tchobanoglous, George, and Frank Kreith, *Handbook of Solid Waste Management*, 2nd ed., New York: McGraw-Hill, 2002.

Gas Flux

$$N_A = \frac{D\eta^{4/3}(C_{A_{atm}} - C_{A_{fill}})}{L}$$

where

- N_A = gas flux of compound A, g/(cm²•s) [lb-mol/(ft²-d)]
- $C_{A_{atm}}$ = concentration of compound A at the surface of the landfill cover, g/cm³ (lb-mol/ft³)
- $C_{A_{fill}}$ = concentration of compound A at the bottom of the landfill cover, g/cm³ (lb-mol/ft³)
- L = depth of the landfill cover, cm (ft)

Typical values for the coefficient of diffusion for methane and carbon dioxide are 0.20 cm²/s (18.6 ft²/d) and 0.13 cm²/s (12.1 ft²/d), respectively.

- D = diffusion coefficient, cm²/s (ft²/d)
- η_{gas} = gas-filled porosity, cm³/cm³ (ft³/ft³)
- η = porosity, cm³/cm³ (ft³/ft³)

Soil Landfill Cover Water Balance

$$\Delta S_{LC} = P - R - ET - PER_{sw}$$

where

- ΔS_{LC} = change in the amount of water held in storage in a unit volume of landfill cover (in.)
- P = amount of precipitation per unit area (in.)
- R = amount of runoff per unit area (in.)
- ET = amount of water lost through evapotranspiration per unit area (in.)
- PER_{sw} = amount of water percolating through the unit area of landfill cover into compacted solid waste (in.)

Tchobanoglous and Kreith, *Handbook of Solid Waste Management*, 2nd ed., McGraw-Hill, 2002.

Compaction

$$\text{Volume Reduction (\%)} = \frac{V_i - V_f}{V_i} \times 100$$

where

V_i = initial volume of wastes before compaction (yd³)

V_f = final volume of wastes after compaction (yd³)

Population Modeling

Population Projection Equations

Linear Projection = Algebraic Projection

$$P_t = P_0 + k\Delta t$$

where

P_t = population at time t

P_0 = population at time zero

k = growth rate

Δt = elapsed time in years relative to time zero

Log Growth = Exponential Growth = Geometric Growth

$$P_t = P_0 e^{k\Delta t}$$

$$\ln P_t = \ln P_0 + k\Delta t$$

where

P_t = population at time t

P_0 = population at time zero

k = growth rate

Δt = elapsed time in years relative to time zero

Percent Growth

$$P_t = P_0(1 + k)^n$$

where

P_t = population at time t

P_0 = population at time zero

k = growth rate

n = number of periods

Ratio and Correlation Growth

$$\frac{P_2}{P_{2R}} = \frac{P_1}{P_{1R}} = k$$

where

P_2 = projected population

P_{2R} = projected population of a larger region

P_1 = population at last census

P_{1R} = population of larger region at last census

k = growth ratio constant

Decreasing-Rate-of-Increase Growth

$$P_t = P_0 + (S - P_0)(1 - e^{-k(t-t_0)})$$

where

- P_t = population at time t
- P_0 = population at time zero
- k = growth rate constant
- S = saturation population
- t, t_0 = future time, initial time

Radiation

Effective Half-Life

Effective half-life τ_e is the combined radioactive and biological half-life.

$$\frac{1}{\tau_e} = \frac{1}{\tau_r} + \frac{1}{\tau_b}$$

where

- τ_r = radioactive half-life
- τ_b = biological half-life

Half-Life

$$N = N_0 e^{-0.693 t/\tau}$$

where

- N_0 = original number of atoms
- N = final number of atoms
- t = time
- τ = half-life
- Flux at distance 2 = (Flux at distance 1) $(r_1/r_2)^2$

where r_1 and r_2 are distances from source.

The half-life of a biologically degraded contaminant assuming a first-order rate constant is given by:

$$t_{1/2} = \frac{0.693}{k}$$

where

- k = rate constant (time⁻¹)
- $t_{1/2}$ = half-life (time)

Daughter Product Activity

$$N_2 = \frac{\lambda_1 N_{10}}{\lambda_2 - \lambda_1} (e^{-\lambda_1 t} - e^{-\lambda_2 t})$$

where

- $\lambda_{1,2}$ = decay constants (time⁻¹)
- N_{10} = initial activity (curies) of parent nuclei
- t = time

Daughter Product Maximum Activity Time

$$t' = \frac{\ln \lambda_2 - \ln \lambda_1}{\lambda_2 - \lambda_1}$$

Inverse Square Law

$$\frac{I_1}{I_2} = \frac{(R_2)^2}{(R_1)^2}$$

where

$I_{1,2}$ = Radiation intensity at locations 1 and 2

$R_{1,2}$ = Distance from the source at locations 1 and 2

Sampling and Monitoring

Data Quality Objectives (DQO) for Sampling Soils and Solids

Investigation Type	Confidence Level (1- α) (%)	Power (1- β) (%)	Minimum Detectable Relative Difference (%)
Preliminary site investigation	70-80	90-95	10-30
Emergency clean-up	80-90	90-95	10-20
Planned removal and remedial response operations	90-95	90-95	10-20

Confidence level: 1- (Probability of a Type I error) = 1 - α = size probability of not making a Type I error.

Power = 1- (Probability of a Type II error) = 1 - β = probability of not making a Type II error.

EPA Document "EPA/600/8-89/046" *Soil Sampling Quality Assurance User's Guide*, Chapter 7.

$$CV = (100 * s) / \bar{x}$$

where

CV = coefficient of variation

s = standard deviation of sample

\bar{x} = sample average

Minimum Detectable Relative Difference = Relative increase over background $[100 (\mu_s - \mu_B) / \mu_B]$ to be detectable with a probability (1 - β)

where

μ_s = mean of pollutant concentration of the site of the contamination

μ_B = mean of pollutant concentration of the site before contamination or the noncontaminated area (background)

Number of Samples Required in a One-Sided One-Sample t-Test to Achieve a Minimum Detectable Relative Difference at Confidence Level (1- α) and Power (1- β)

Coefficient of Variation (%)	Power (%)	Confidence Level (%)	Minimum Detectable Relative Difference (%)				
			5	10	20	30	40
15	95	99	145	39	12	7	5
		95	99	26	8	5	3
		90	78	21	6	3	3
		80	57	15	4	2	2
	90	99	120	32	11	6	5
		95	79	21	7	4	3
		90	60	16	5	3	2
		80	41	11	3	2	1
	80	99	94	26	9	6	5
		95	58	16	5	3	3
		90	42	11	4	2	2
		80	26	7	2	2	1
25	95	99	397	102	28	14	9
		95	272	69	19	9	6
		90	216	55	15	7	5
		80	155	40	11	5	3
	90	99	329	85	24	12	8
		95	272	70	19	9	6
		90	166	42	12	6	4
		80	114	29	8	4	3
	80	99	254	66	19	10	7
		95	156	41	12	6	4
		90	114	30	8	4	3
		80	72	19	5	3	2
35	95	99	775	196	42	25	15
		95	532	134	35	17	10
		90	421	106	28	13	8
		80	304	77	20	9	6
	90	99	641	163	43	21	13
		95	421	107	28	14	8
		90	323	82	21	10	6
		80	222	56	15	7	4
	80	99	495	126	34	17	11
		95	305	78	21	10	7
		90	222	57	15	7	5
		80	140	36	10	5	3

Wastewater Treatment and Technologies

Specific Gravity for a Solids Slurry

$$S = \frac{W_w + W_s}{(W_w/1.00) + (W_s/S_s)}$$

where

S = specific gravity of wet sludge

W_w = weight of water (lb)

W_s = weight of dry solids (lb)

S_s = specific gravity of dry solids

The volume of waste sludge for a given amount of dry matter and concentration of solids is given by

$$V = \frac{W_s}{(s/100)\gamma S} = \frac{W_s}{[(100-p)/100]\gamma S}$$

where

V = volume of sludge, ft³ (gal) [m³]

W_s = weight of dry solids (lb or kg)

s = solids content (%)

γ = unit weight of water, 62.4 lb/ft³ (8.34 lb/gal) [1,000 kg/m³]

S = specific gravity of wet sludge

p = water content (%)

BOD₅ for Mixed Lagoons in Series

$$\frac{S}{S^0} = \frac{1}{1 + k_p \theta}$$

where

S^0 = Inlet total BOD₅

S = Outlet total BOD₅

θ = Fresh-feed residence time

k_p = Kinetic constant (time⁻¹)

National Research Council (NRC) Trickling Filter Performance

For a single-stage or first-stage rock filter, the equation is

$$E_1 = \frac{100}{1 + 0.0561 \sqrt{\frac{W}{VF}}}$$

where

E_1 = efficiency of BOD removal for process at 20°C, including recirculation and sedimentation, percent

W = BOD loading to filter (lb/day)

V = volume of filter media (10³ ft³)

F = recirculation factor

The recirculation factor is calculated using

$$F = \frac{1 + R}{(1 + R/10)^2}$$

Dechlorination of Sulfite Compounds

Reaction between sodium sulfite and free chlorine residual and combined chlorine residual, as represented by monochloramine:

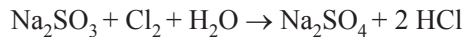

Methanol Requirement for Biologically Treated Wastewater

$$C_m = 2.47N_o + 1.53N_1 + 0.87D_o$$

where

C_m = required methanol concentration (mg/L)

N_o = initial nitrate-nitrogen concentration (mg/L)

N_1 = initial nitrite-nitrogen concentration (mg/L)

D_o = initial dissolved-oxygen concentration (mg/L)

BOD Test Solution and Seeding Procedures

When the dilution of water is not seeded:

$$\text{BOD, mg/L} = \frac{D_1 - D_2}{P}$$

When the dilution of water is seeded:

$$\text{BOD, mg/L} = \frac{(D_1 - D_2) - (B_1 - B_2)f}{P}$$

where

D_1 = dissolved oxygen of diluted sample immediately after preparation (mg/L)

D_2 = dissolved oxygen of diluted sample after 5-day incubation at 20°C (mg/L)

B_1 = dissolved oxygen of seed control before incubation (mg/L)

B_2 = dissolved oxygen of seed control after incubation (mg/L)

f = fraction of seeded dilution water volume in sample to volume of seeded dilution water in seed control

P = fraction of wastewater sample volume to total combined volume

Activated Sludge

$$X_A = \frac{\theta_c Y (S_0 - S_e)}{\theta (1 + k_d \theta_c)}$$

Steady-State Mass Balance around Secondary Clarifier:

$$(Q_0 + Q_R)X_A = Q_e X_e + Q_R X_r + Q_w X_w$$

$$\theta_c = \text{Solids residence time} = \frac{V(X_A)}{Q_w X_w + Q_e X_e}$$

$$\text{Sludge volume/day: } Q_s = \frac{M(100)}{\rho_s (\% \text{ solids})}$$

$$\text{SVI} = \frac{\text{Sludge volume after settling (mL/L)} * 1,000}{\text{MLSS (mg/L)}}$$

where

k_d = microbial death ratio; kinetic constant; day⁻¹; typical range 0.1–0.01, typical domestic wastewater value = 0.05 day⁻¹

S_e = effluent BOD or COD concentration (kg/m³)

S_0 = influent BOD or COD concentration (kg/m³)

X_A = biomass concentration in aeration tank (MLSS or MLVSS kg/m³)

Environmental Engineering

Y = yield coefficient (kg biomass/kg BOD or COD consumed); range 0.4–1.2

θ = hydraulic residence time = V/Q

For clarifier design, solids loading rate (SLR) = $\frac{(Q_0 + Q_R)X_A}{A}$

Organic loading rate (volumetric) = $Q_0 S_0 / \text{Vol}$

Organic loading rate (F:M) = $Q_0 S_0 / (\text{Vol } X_A)$

Organic loading rate (surface area) = $Q_0 S_0 / A_M$

ρ_s = density of solids

A = surface area of unit

A_M = surface area of media in fixed-film reactor

A_x = cross-sectional area of channel

M = sludge production rate (dry weight basis)

Q_0 = influent flowrate

Q_e = effluent flowrate

Q_w = waste sludge flowrate

ρ_s = wet sludge density

R = recycle ratio = Q_R/Q_0

Q_R = recycle flowrate = $Q_0 R$

X_e = effluent suspended solids concentration

X_w = waste sludge suspended solids concentration

V = aeration basin volume

Q = flowrate

X_r = recycled sludge suspended solids concentration

Design and Operational Parameters for Activated-Sludge Treatment of Municipal Wastewater

Type of Process	Mean cell residence time (θ_c , d)	Food-to-mass ratio [(kg BOD ₅ /day·kg MLSS)]	Volumetric loading (kg BOD ₅ /m ³)	Hydraulic residence time in aeration basin (θ , h)	Mixed liquor suspended solids (MLSS, mg/L)	Recycle ratio (Q_r/Q)	Flow regime*	BOD ₅ removal efficiency (%)	Air supplied (m ³ /kg BOD ₅)
Tapered aeration	5–15	0.2–0.4	0.3–0.6	4–8	1,500–3,000	0.25–0.5	PF	85–95	45–90
Conventional	4–15	0.2–0.4	0.3–0.6	4–8	1,500–3,000	0.25–0.5	PF	85–95	45–90
Step aeration	4–15	0.2–0.4	0.6–1.0	3–5	2,000–3,500	0.25–0.75	PF	85–95	45–90
Completely mixed	4–15	0.2–0.4	0.8–2.0	3–5	3,000–6,000	0.25–1.0	CM	85–95	45–90
Contact stabilization	4–15	0.2–0.6	1.0–1.2			0.25–1.0			45–90
Contact basin				0.5–1.0	1,000–3,000		PF	80–90	
Stabilization basin				4–6	4,000–10,000		PF		
High-rate aeration	4–15	0.4–1.5	1.6–16	0.5–2.0	4,000–10,000	1.0–5.0	CM	75–90	25–45
Pure oxygen	8–20	0.2–1.0	1.6–4	1–3	6,000–8,000	0.25–0.5	CM	85–95	
Extended aeration	20–30	0.05–0.15	0.16–0.40	18–24	3,000–6,000	0.75–1.50	CM	75–90	90–125

*PF = plug flow, CM = completely mixed.

Metcalf and Eddy, *Wastewater Engineering: Treatment, Disposal, and Reuse*, 3rd ed., McGraw-Hill, 1991.

Facultative Pond

BOD Loading Total System ≤ 35 pounds BOD₅/(acre-day)

Minimum = 3 ponds

Depth = 3–8 ft

Minimum t = 90–120 days

Biotower

Fixed-Film Equation without Recycle

$$\frac{S_e}{S_0} = e^{-kD/q^n}$$

Fixed-Film Equation with Recycle

$$\frac{S_e}{S_a} = \frac{e^{-kD/q^n}}{(1 + R) - R(e^{-kD/q^n})}$$

where

S_e = effluent BOD₅ (mg/L)

S_0 = influent BOD₅ (mg/L)

R = recycle ratio = Q_R/Q_0

Q_R = recycle flowrate

$$S_a = \frac{S_0 + RS_e}{1 + R}$$

D = depth of biotower media (m)

q = hydraulic loading [$m^3/(m^2 \cdot \text{min})$] ($(Q_0 + RQ_0)/A_{\text{plan}}$ (with recycle))

k = treatability constant; functions of wastewater and medium (min^{-1}); range 0.01–0.1; for municipal wastewater and modular plastic media 0.06 min^{-1} @ 20°C

$$k_T = k_{20}(1.035)^{T-20}$$

n = coefficient relating to media characteristics; modular plastic, $n = 0.5$

Aerobic Digestion

Design criteria for aerobic digesters^a

Parameter	Value
Sludge retention time (day)	
At 20°C	40
At 15°C	60
Solids loading (lb volatile solids/ft ³ -day)	0.1–0.3
Oxygen requirements (lb O ₂ /lb solids destroyed)	
Cell tissue	~2.3
BOD ₅ in primary sludge	1.6–1.9
Energy requirements for mixing	
Mechanical aerators (hp/10 ³ ft ³)	0.7–1.50
Diffused-air mixing (ft ³ /10 ³ ft ³ -min)	20–40
Dissolved-oxygen residual in liquid (mg/L)	1–2
Reduction in volatile suspended solids (VSS) (%)	40–50

Tank Volume

$$V = \frac{Q_i(X_i + FS_i)}{X_d(k_d P_v + 1/\theta_c)}$$

where

V = volume of aerobic digester (ft³)

Q_i = influent average flowrate to digester (ft³/day)

X_i = influent suspended solids (mg/L)

F = fraction of the influent BOD₅ consisting of raw primary sludge (expressed as a decimal)

S_i = influent BOD₅ (mg/L)

X_d = digester suspended solids (mg/L); typically $X_d = (0.7)X_i$

k_d = reaction-rate constant (day^{-1})

P_v = volatile fraction of digester suspended solids (expressed as a decimal)

θ_c = solids residence time (sludge age) (day)

FS_i can be neglected if primary sludge is not included on the sludge flow to the digester.

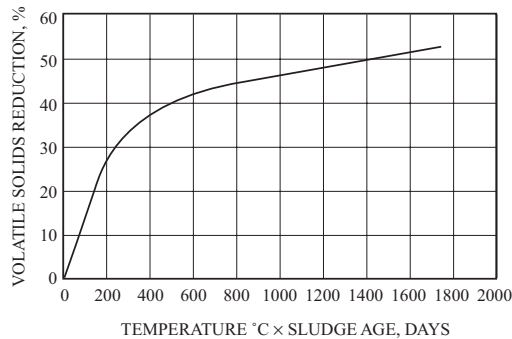

VOLATILE SOLIDS REDUCTION IN AN AEROBIC DIGESTER AS A FUNCTION OF DIGESTER LIQUID TEMPERATURE AND DIGESTER SLUDGE AGE

Tchobanoglous, G., and Metcalf and Eddy, *Wastewater Engineering: Treatment, Disposal, and Reuse*, 4th ed., McGraw-Hill, 2003.

Anaerobic Digestion

Design parameters for anaerobic digesters

Parameter	Standard-rate	High-rate
Solids residence time (day)	30–90	10–20
Volatile solids loading ($\text{kg}/\text{m}^3/\text{day}$)	0.5–1.6	1.6–6.4
Digested solids concentration (%)	4–6	4–6
Volatile solids reduction (%)	35–50	45–55
Gas production (m^3/kg VSS added)	0.5–0.55	0.6–0.65
Methane content (%)	65	65

Standard Rate

$$\text{Reactor Volume} = \frac{V_1 + V_2}{2} t_r + V_2 t_s$$

High Rate

First stage

$$\text{Reactor Volume} = V_1 t_r$$

Second Stage

$$\text{Reactor Volume} = \frac{V_1 + V_2}{2} t_t + V_2 t_s$$

where

V_1 = raw sludge input (volume/day)

V_2 = digested sludge accumulation (volume/day)

t_r = time to react in a high-rate digester = time to react and thicken in a standard-rate digester

t_t = time to thicken in a high-rate digester

t_s = storage time

Peavy, HS, D.R. Rowe, and G. Tchobanoglous, *Environmental Engineering*, New York, McGraw-Hill, 1985.

Water Treatment Technologies

Activated Carbon Adsorption

Freundlich Isotherm

$$\frac{x}{m} = X = KC_e^{1/n}$$

where

x = mass of solute adsorbed

m = mass of adsorbent

X = mass ratio of the solid phase—that is, the mass of adsorbed solute per mass of adsorbent

C_e = equilibrium concentration of solute, mass/volume

K, n = experimental constants

Linearized Form

$$\ln \frac{x}{m} = \frac{1}{n} \ln C_e + \ln K$$

For linear isotherm, $n = 1$

Langmuir Isotherm

$$\frac{x}{m} = X = \frac{aKC_e}{1 + KC_e}$$

where

a = mass of adsorbed solute required to saturate completely a unit mass of adsorbent

K = experimental constant

Linearized Form

$$\frac{m}{x} = \frac{1}{a} + \frac{1}{aK} \frac{1}{C_e}$$

Depth of Sorption Zone

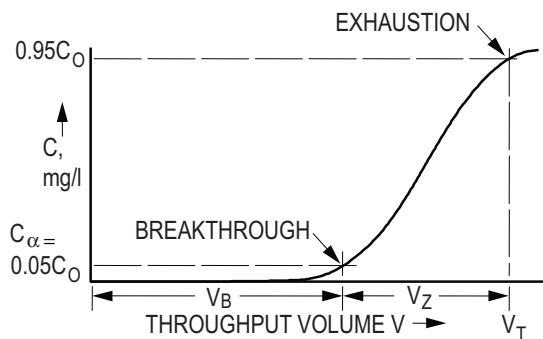

$$Z_s = Z \left[\frac{V_Z}{V_T - 0.5V_Z} \right]$$

where

- $V_Z = V_T - V_B$
- $Z_S =$ depth of sorption zone
- $Z =$ total carbon depth
- $V_T =$ total volume treated at exhaustion ($C = 0.95 C_0$)
- $V_B =$ total volume at breakthrough ($C = C_\alpha = 0.05 C_0$)
- $C_0 =$ concentration of contaminant in influent

Air Stripping

- $P_i = HC_i =$ Henry's Law
- $P_i =$ partial pressure of component i (atm)
- $H =$ Henry's Law constant ($\text{atm}\cdot\text{m}^3/\text{kmol}$)
- $C_i =$ concentration of component i in solvent (kmol/m^3)

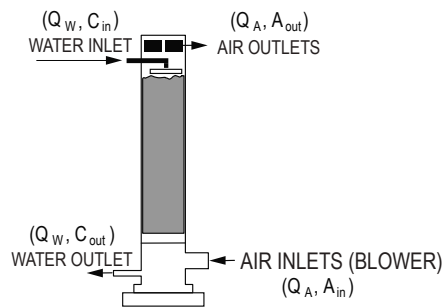

$$A_{\text{out}} = H' C_{\text{in}}$$

$$Q_W \cdot C_{\text{in}} = Q_A H' C_{\text{in}}$$

$$Q_W = Q_A H'$$

$$H' (Q_A / Q_W) = 1$$

where

- $A_{\text{out}} =$ concentration in the effluent air (kmol/m^3); in this formulation of the equation A_{in} and C_{out} are assumed to be negligible for simplicity.
- $Q_W =$ water flowrate (m^3/s)
- $Q_A =$ air flowrate (m^3/s)
- $A_{\text{in}} =$ concentration of contaminant in air (kmol/m^3)
- $C_{\text{out}} =$ concentration of contaminants in effluent water (kmol/m^3)
- $C_{\text{in}} =$ concentration of contaminants in influent water (kmol/m^3)

Stripper Packing Height = Z

$$Z = HTU \times NTU$$

Assuming rapid equilibrium:

$$NTU = \left(\frac{R_S}{R_S - 1} \right) \ln \left(\frac{(C_{\text{in}}/C_{\text{out}})(R_S - 1) + 1}{R_S} \right)$$

where

- $NTU =$ number of transfer units
- $H =$ Henry's Law constant
- $H' = H/RT =$ dimensionless Henry's Law constant
- $T =$ temperature in units consistent with K
- $R =$ universal gas constant [$\text{atm}\cdot\text{m}^3/(\text{kmol}\cdot\text{K})$]
- $R_S =$ stripping factor $H'(Q_A/Q_W)$
- $C_{\text{in}} =$ concentration in the influent water (kmol/m^3)
- $C_{\text{out}} =$ concentration in the effluent water (kmol/m^3)
- $HTU =$ Height of Transfer Units $= \frac{L}{M_w K_L a}$

where

- L = liquid molar loading rate [kmol/(s•m²)]
- M_w = molar density of water (55.6 kmol/m³) = 3.47 lbmol/ft³
- $K_L a$ = overall transfer rate constant (s⁻¹)

Clarifier

- Overflow rate = Hydraulic loading rate = $v_o = Q/A_{\text{surface}}$
- v_o = critical settling velocity; terminal settling velocity of smallest particle that is 100% removed
- Weir loading = weir overflow rate, WOR = $Q/\text{Weir Length}$
- Horizontal velocity = approach velocity = $v_h = Q/A_{\text{cross-section}} = Q/A_x$
- Hydraulic residence time = $V/Q = \theta$

where

- Q = flowrate
- A_x = cross-sectional area
- A = surface area, plan view
- V = tank volume

Typical Primary Clarifier Efficiency Percent Removal

	Overflow rates			
	1,200	1,000	800	600
	(gpd/ft ²)	(gpd/ft ²)	(gpd/ft ²)	(gpd/ft ²)
Suspended Solids	48.9	40.7	32.6	24.4
	(m/d)	(m/d)	(m/d)	(m/d)
	54%	58%	64%	68%
BOD ₅	30%	32%	34%	36%

Design Criteria for Sedimentation Basins

Type of Basin	Overflow Rate		Solids Loading Rate				Hydraulic Residence Time (hr)	Depth (ft)		
	Average	Peak	Average	Peak	Average	Peak				
	(gpd/ft ²)	(m ³ /m ² •d)	(gpd/ft ²)	(m ³ /m ² •d)	(lb/ft ² -d)	(kg/m ² •h)			(lb/ft ² -h)	(kg/m ² •h)
Water Treatment										
Clarification following coagulation and flocculation:										
Alum coagulation	350-550	14-22						4-8	12-16	
Ferric coagulation	550-700	22-28						4-8	12-16	
Upflow clarifiers										
Groundwater	1,500-2,200	61-90						1		
Surface water	1,000-1,500	41-61						4		
Clarification following lime-soda softening										
Conventional										
Upflow clarifiers	550-1,000	22-41						2-4		
Groundwater										
Upflow clarifiers	1,000-2,500	41-102						1		
Surface water										
Upflow clarifiers	1,000-1,800	41-73						4		
Wastewater Treatment										
Primary clarifiers	800-1,200	32-49	1,200-2,000	50-80				2	10-12	
Settling basins following fixed film reactors	400-800	16-33						2		
Settling basins following air-activated sludge reactors										
All configurations EXCEPT extended aeration										
Extended aeration	400-700	16-28	1,000-1,200	40-64	19-29	4-6	38	8	2	12-15
Extended aeration	200-400	8-16	600-800	24-32	5-24	1-5	34	7	2	12-15
Settling basins following chemical flocculation reactors	800-1,200							2		

Metcalf and Eddy; AECOM, *Wastewater Engineering: Treatment and Resource Recovery*, 5th ed., New York: McGraw-Hill, 2014, p. 190, Table 8-34.

Weir Loadings

1. Water Treatment—weir overflow rates should not exceed 20,000 gpd/ft
2. Wastewater Treatment
 - a. Flow ≤ 1 MGD: weir overflow rates should not exceed 10,000 gpd/ft
 - b. Flow > 1 MGD: weir overflow rates should not exceed 15,000 gpd/ft

Horizontal Velocities

1. Water Treatment—horizontal velocities should not exceed 0.5 fpm
2. Wastewater Treatment—no specific requirements (use the same criteria as for water)

Dimensions

1. Rectangular Tanks
 - a. Length:Width ratio = 3:1 to 5:1
 - b. Basin width is determined by the scraper width (or multiples of the scraper width)
 - c. Bottom slope is set at 1%
2. Circular Tanks
 - a. Diameters up to 200 ft
 - b. Diameters must match the dimensions of the sludge scraping mechanism
 - c. Bottom slope is less than 8%

Settling Equations

General Spherical

$$v_t = \sqrt{\frac{4g(\rho_p - \rho_f)d}{3C_D\rho_f}}$$

where

- C_D = drag coefficient
 = 24/Re (Laminar; Re ≤ 1.0)
 = 24/Re + 3/(Re^{1/2}) + 0.34 (Transitional)
 = 0.4 (Turbulent; Re ≥ 10⁴)
- Re = Reynolds number = $\frac{v_t \rho d}{\mu}$
- g = gravitational constant
- ρ_p = density of particle
- ρ_f = density of fluid
- d = diameter of sphere
- μ = bulk viscosity of liquid = absolute viscosity
- v_t = terminal settling velocity

Stokes' Law

$$v_t = \frac{g(\rho_p - \rho_f)d^2}{18\mu} = \frac{g \rho_f (S.G. - 1)d^2}{18\mu}$$

Approach velocity = horizontal velocity = Q/A_x

Hydraulic loading rate = Q/A

Hydraulic residence time = $V/Q = \theta$

where

- Q = flowrate
- A_x = cross-sectional area
- A = surface area, plan view
- V = tank volume
- ρ_f = fluid mass density
- $S.G.$ = specific gravity

Filtration Equations

Filter bay length-to-width ratio = 1.2:1 to 1.5:1

Effective size = d_{10}

Uniformity coefficient = d_{60}/d_{10}

d_x = diameter of particle class for which $x\%$ of sample is less than (m or ft)

Filter equations can be used with any consistent set of units.

Head Loss Through Clean Bed

Rose Equation

$$\begin{array}{ll} \text{Monosized Media} & \text{Multisized Media} \\ h_f = \frac{1.067(v_s)^2 LC_D}{g\eta^4 d} & h_f = \frac{1.067(v_s)^2 L}{g\eta^4} \sum \frac{C_{D_{ij}} x_{ij}}{d_{ij}} \end{array}$$

Carmen-Kozeny Equation

$$\begin{array}{ll} \text{Monosized Media} & \text{Multisized Media} \\ h_f = \frac{f' L (1 - \eta) v_s^2}{\eta^3 g d} & h_f = \frac{L (1 - \eta) v_s^2}{\eta^3 g} \sum \frac{f'_{ij} x_{ij}}{d_{ij}} \end{array}$$

$$f' = \text{friction factor} = 150 \left(\frac{1 - \eta}{\text{Re}} \right) + 1.75$$

where

h_f = head loss through the clean bed (m of H₂O)

L = depth of filter media (m)

η = porosity of bed = void volume/total volume

v_s = filtration rate = empty bed approach velocity (m/s) = Q/A_{plan}

g = gravitational acceleration (m/s²)

Re = Reynolds number = $\frac{v_s \rho d}{\mu}$

d_{ij} , d = diameter of filter media particles; arithmetic average of adjacent screen openings (m)

i = filter media (sand, anthracite, garnet)

j = filter media particle size

x_{ij} = mass fraction of media retained between adjacent sieves

f'_{ij} = friction factors for each media fraction

C_D = drag coefficient as defined in settling velocity equations

Bed Expansion

$$\begin{array}{ll} \text{Monosized} & \text{Multisized} \\ L_f = \frac{L_o (1 - \eta_o)}{1 - \left(\frac{v_B}{v_t} \right)^{0.22}} & L_f = L_o (1 - \eta_o) \sum \frac{x_{ij}}{1 - \left(\frac{v_B}{v_{t,ij}} \right)^{0.22}} \end{array}$$

$$\eta_f = \left(\frac{v_B}{v_t} \right)^{0.22}$$

where

L_f = depth of fluidized filter media (m)

v_B = backwash velocity (m/s) = $\frac{Q_B}{A_{plan}}$

Q_B = backwash flowrate

v_t = terminal setting velocity

η_f = porosity of fluidized bed

L_o = initial bed depth

η_o = initial bed porosity

Lime-Soda Softening Equations

- | | |
|---|--|
| 1. Carbon dioxide removal | $CO_2 + Ca(OH)_2 \rightarrow CaCO_3(s) + H_2O$ |
| 2. Calcium carbonate hardness removal | $Ca(HCO_3)_2 + Ca(OH)_2 \rightarrow 2CaCO_3(s) + 2H_2O$ |
| 3. Calcium non-carbonate hardness removal | $CaSO_4 + Na_2CO_3 \rightarrow CaCO_3(s) + 2Na^+ + SO_4^{2-}$ |
| 4. Magnesium carbonate hardness removal | $Mg(HCO_3)_2 + 2Ca(OH)_2 \rightarrow 2CaCO_3(s) + Mg(OH)_2(s) + 2H_2O$ |
| 5. Magnesium non-carbonate hardness removal | $MgSO_4 + Ca(OH)_2 + Na_2CO_3 \rightarrow CaCO_3(s) + Mg(OH)_2(s) + 2Na^+ + SO_4^{2-}$ |
| 6. Destruction of excess alkalinity | $2HCO_3^- + Ca(OH)_2 \rightarrow CaCO_3(s) + CO_3^{2-} + 2H_2O$ |
| 7. Recarbonation | $Ca^{2+} + 2OH^- + CO_2 \rightarrow CaCO_3(s) + H_2O$ |

Molecular Formulas	Molecular Weight	<i>n</i>		Equivalent Weight
		#	Equiv per mole	
CO ₃ ²⁻	60.0	2		30.0
CO ₂	44.0	2		22.0
Ca(OH) ₂	74.1	2		37.1
CaCO ₃	100.1	2		50.0
Ca(HCO ₃) ₂	162.1	2		81.1
CaSO ₄	136.1	2		68.1
Ca ²⁺	40.1	2		20.0
H ⁺	1.0	1		1.0
HCO ₃ ⁻	61.0	1		61.0
Mg(HCO ₃) ₂	146.3	2		73.2
Mg(OH) ₂	58.3	2		29.2
MgSO ₄	120.4	2		60.2
Mg ²⁺	24.3	2		12.2
Na ⁺	23.0	1		23.0
Na ₂ CO ₃	106.0	2		53.0
OH ⁻	17.0	1		17.0
SO ₄ ²⁻	96.1	2		48.0

Coagulation Equations

Insoluble products are shown in italics.

1. Aluminum sulfate in natural alkaline water

$$Al_2(SO_4)_3 + 3 Ca(HCO_3)_2 \Leftrightarrow 2 Al(OH)_3 + 3 CaSO_4 + 6 CO_2$$
2. Aluminum sulfate plus soda ash

$$Al_2(SO_4)_3 + 3 NaCO_3 + 3 H_2O \Leftrightarrow 2 Al(OH)_3 + 3 NaSO_4 + 3 CO_2$$
3. Ferric sulfate

$$Fe_2(SO_4)_3 + 3 Ca(HCO_3)_2 \Leftrightarrow 2 Fe(OH)_3 + 3 CaSO_4 + 6 CO_2$$

4. Ferric chloride

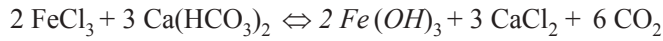

Phosphorus Removal Equations

1. Ferric chloride

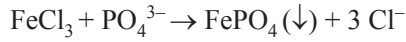

2. Ferrous chloride

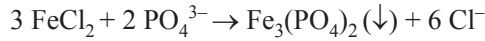

3. Aluminum sulfate (alum)

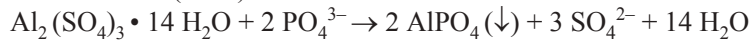

Common Radicals in Water

Molecular Formulas	Molecular Weight	<i>n</i>		Equivalent Weight
		#	Equiv per mole	
CO ₃ ²⁻	60.0	2		30.0
CO ₂	44.0	2		22.0
Ca(OH) ₂	74.1	2		37.1
CaCO ₃	100.1	2		50.0
Ca(HCO ₃) ₂	162.1	2		81.1
CaSO ₄	136.1	2		68.1
Ca ²⁺	40.1	2		20.0
H ⁺	1.0	1		1.0
HCO ₃ ⁻	61.0	1		61.0
Mg(HCO ₃) ₂	146.3	2		73.2
Mg(OH) ₂	58.3	2		29.2
MgSO ₄	120.4	2		60.2
Mg ²⁺	24.3	2		12.2
Na ⁺	23.0	1		23.0
Na ₂ CO ₃	106.0	2		53.0
OH ⁻	17.0	1		17.0
SO ₄ ²⁻	96.1	2		48.0

Typical Operating Ranges for Coagulation with Alum and Ferric Chloride

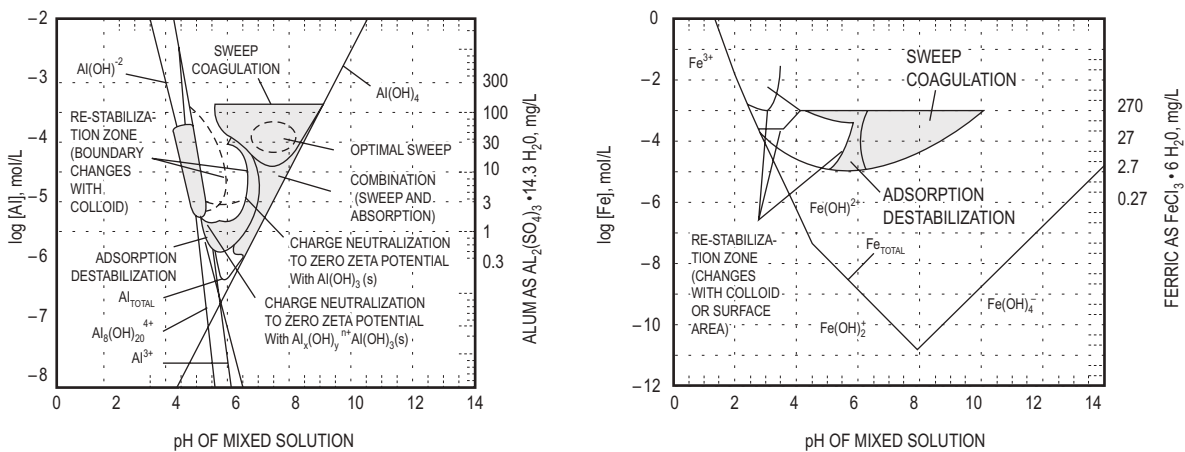

Metcalf and Eddy; AECOM, *Wastewater Engineering: Treatment and Resource Recovery*, 5th ed., New York: McGraw-Hill, 2014, p. 473.

Rapid Mix and Flocculator Design

$$G = \sqrt{\frac{P}{\mu V}} = \sqrt{\frac{\gamma H_L}{t \mu}}$$

$$Gt = 10^4 \text{ to } 10^5$$

where

G = root mean square velocity gradient (mixing intensity) [ft/(sec-ft) or m/(s•m)]

P = power to the fluid (ft-lb/sec or N•m/s)

V = volume (ft³ or m³)

μ = dynamic viscosity [lb/(ft-sec) or Pa•s]

γ = specific weight of water (lb/ft³ or N/m³)

H_L = head loss (ft or m)

t = time (sec or s)

Reel and Paddle

$$P = \frac{C_D A_p \rho_f v_r^3}{2}$$

where

C_D = drag coefficient = 1.8 for flat blade with a L:W > 20:1

A_p = area of blade (m²) perpendicular to the direction of travel through the water

ρ_f = density of H₂O (kg/m³)

v_p = velocity of paddle (m/s)

v_r = relative or effective paddle velocity

= v_p • slip coefficient

slip coefficient = 0.5 to 0.75

Turbulent Flow Impeller Mixer

$$P = K_T (n)^3 (D_i)^5 \rho_f$$

where

K_T = impeller constant (see table)

n = rotational speed (rev/sec)

D_i = impeller diameter (m)

Values of the Impeller Constant K_T
(Assume Turbulent Flow)

Type of Impeller	K_T
Propeller, pitch of 1, 3 blades	0.32
Propeller, pitch of 2, 3 blades	1.00
Turbine, 6 flat blades, vaned disc	6.30
Turbine, 6 curved blades	4.80
Fan turbine, 6 blades at 45°	1.65
Shrouded turbine, 6 curved blades	1.08
Shrouded turbine, with stator, no baffles	1.12

Note: Constant assumes baffled tanks having four baffles at the tank wall with a width equal to 10% of the tank diameter.

Reprinted with permission from *Industrial & Engineering Chemistry*,
"Mixing of Liquids in Chemical Processing," J. Henry Rushton, 1952,
v. 44, no. 12. p. 2934, American Chemical Society.

Reverse Osmosis

Osmotic Pressure of Solutions of Electrolytes

$$\Pi = \phi v \frac{n}{V} RT$$

where

Π = osmotic pressure (Pa)

ϕ = osmotic coefficient

v = number of ions formed from one molecule of electrolyte

n = number of moles of electrolyte

V = specific volume of solvent (m^3/kmol)

R = universal gas constant [$\text{Pa} \cdot \text{m}^3/(\text{kmol} \cdot \text{K})$]

T = absolute temperature (K)

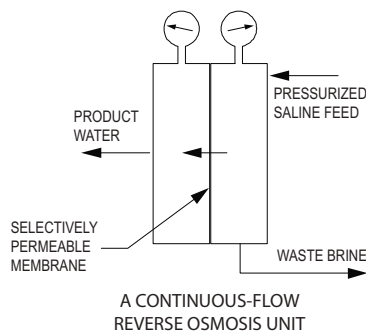

Salt Flux through the Membrane

$$J_s = (D_s K_s / \Delta Z)(C_{in} - C_{out})$$

where

J_s = salt flux through the membrane [$\text{kmol}/(\text{m}^2 \cdot \text{s})$]

D_s = diffusivity of the solute in the membrane (m^2/s)

K_s = solute distribution coefficient (dimensionless)

C = concentration (kmol/m^3)

ΔZ = membrane thickness (m)

$$J_s = K_p (C_{in} - C_{out})$$

K_p = membrane solute mass-transfer coefficient

$$= \frac{D_s K_s}{\Delta Z} (L/t, m/s)$$

Water Flux

$$J_w = W_p (\Delta P - \Delta \pi)$$

where

J_w = water flux through the membrane [$\text{kmol}/(\text{m}^2 \cdot \text{s})$]

W_p = coefficient of water permeation, a characteristic of the particular membrane [$\text{kmol}/(\text{m}^2 \cdot \text{s} \cdot \text{Pa})$]

ΔP = pressure differential across membrane = $P_{in} - P_{out}$ (Pa)

$\Delta \pi$ = osmotic pressure differential across membrane $\pi_{in} - \pi_{out}$ (Pa)

Ultrafiltration

$$J_w = \frac{\varepsilon r^2 \int \Delta P}{8\mu\delta}$$

where

- ε = membrane porosity
- r = membrane pore size
- ΔP = net transmembrane pressure
- μ = viscosity
- δ = membrane thickness
- J_w = volumetric flux (m/s)

Disinfection

Chlorine contact chamber length-to-width ratio = 20:1 to 50:1

$$CT_{\text{calc}} = C \times t_{10}$$

where

- CT_{calc} = calculated CT value (mg • mm/L)
- C = residual disinfectant concentration measured during peak hourly flow (mg/L)
- t_{10} = time it takes 10% of the water to flow through the reactor measured during peak hourly flow (min)
= can be determined from traces study data or the following relationship, $t_{10(\text{approx})} = \theta \times BF$
- θ = hydraulic residence time (min)
- BF = baffling factor

Adapted from Guidance Manual LT1ESWTR Disinfection Profiling and Benchmarking, U.S. Environmental Protection Agency, 2003.

Baffling Factors

Baffling Condition	Baffling Factor	Baffling Description
Unbaffled (mixed flow)	0.1	None, agitated basin, very low length to width ratio, high inlet and outlet flow velocities.
Poor	0.3	Single or multiple unbaffled inlets and outlets, no intra-basin baffles.
Average	0.5	Baffled inlet or outlet with some intra-basin baffles.
Superior	0.7	Perforated inlet baffle, serpentine or perforated intra-basin baffles, outlet weir or perforated launders.
Perfect (plug flow)	1.0	Very high length to width ratio (pipeline flow), perforated inlet, outlet, and intra-basin baffles.

Guidance Manual LT1ESWTR Disinfection Profiling and Benchmarking, U.S. Environmental Protection Agency, 2003.

Removal and Inactivation Requirements

Microorganism	Required Log Reduction	Treatment
<i>Giardia</i>	3-log (99.9%)	Removal and/or inactivation
Viruses	4-log (99.99%)	Removal and/or inactivation
<i>Cryptosporidium</i>	2-log (99%)	Removal

Guidance Manual LT1ESWTR Disinfection Profiling and Benchmarking, U.S. Environmental Protection Agency, 2003.

Typical Removal Credits and Inactivation Requirements for Various Treatment Technologies

Process	Typical Log Removal Credits		Resulting Disinfection Log Inactivation Requirements	
	<i>Giardia</i>	Viruses	<i>Giardia</i>	Viruses
Conventional Treatment	2.5	2.0	0.5	2.0
Direct Filtration	2.0	1.0	1.0	3.0
Slow Sand Filtration	2.0	2.0	1.0	2.0
Diatomaceous Earth Filtration	2.0	1.0	1.0	3.0
Unfiltered	0	0	3.0	4.0

Guidance Manual LTIESWTR Disinfection Profiling and Benchmarking, U.S. Environmental Protection Agency, 2003.

CT Values* For 3-LOG Inactivation Of *Giardia* Cysts By Free Chlorine

Chlorine Concentration (mg/L)	Temperature <= 0.5°C								Temperature = 5°C								Temperature = 10°C							
	pH								pH								pH							
	<=6.0	6.5	7.0	7.5	8.0	8.5	9.0	<=6.0	6.5	7.0	7.5	8.0	8.5	9.0	<=6.0	6.5	7.0	7.5	8.0	8.5	9.0			
<=0.4	137	163	195	237	277	329	390	97	117	139	166	198	236	279	73	88	104	125	149	177	209			
0.6	141	168	200	239	286	342	407	100	120	143	171	204	244	291	75	90	107	128	153	183	218			
0.8	145	172	205	246	295	354	422	103	122	146	175	210	252	301	78	92	110	131	158	189	226			
1.0	148	176	210	253	304	365	437	105	125	149	179	216	260	312	79	94	112	134	162	195	234			
1.2	152	180	215	259	313	376	451	107	127	152	183	221	267	320	80	95	114	137	166	200	240			
1.4	155	184	221	266	321	387	464	109	130	155	187	227	274	329	82	98	116	140	170	206	247			
1.6	157	189	226	273	329	397	477	111	132	158	192	232	281	337	83	99	119	144	174	211	253			
1.8	162	193	231	279	338	407	489	114	135	162	196	238	287	345	86	101	122	147	179	215	259			
2.0	165	197	236	286	346	417	500	116	138	165	200	243	294	353	87	104	124	150	182	221	265			
2.2	169	201	242	297	353	426	511	118	140	169	204	248	300	361	89	105	127	153	186	225	271			
2.4	172	205	247	298	361	435	522	120	143	172	209	253	306	368	90	107	129	157	190	230	276			
2.6	175	209	252	304	368	444	533	122	146	175	213	258	312	375	92	110	131	160	194	234	281			
2.8	178	213	257	310	375	452	543	124	148	178	217	263	318	382	93	111	134	163	197	239	287			
3.0	181	217	261	316	382	460	552	126	151	182	221	268	324	389	95	113	137	166	201	243	292			
Chlorine Concentration (mg/L)	Temperature = 15°C								Temperature = 20°C								Temperature = 25°C							
	pH								pH								pH							
	<=6.0	6.5	7.0	7.5	8.0	8.5	9.0	<=6.0	6.5	7.0	7.5	8.0	8.5	9.0	<=6.0	6.5	7.0	7.5	8.0	8.5	9.0			
<=0.4	49	59	70	83	99	118	140	36	44	52	62	74	89	105	24	29	35	42	50	59	70			
0.6	50	60	72	86	102	122	146	38	45	54	64	77	92	109	25	30	36	43	51	61	73			
0.8	52	61	73	88	105	126	151	39	46	55	66	79	95	113	26	31	37	44	53	63	75			
1.0	53	63	75	90	108	130	156	39	47	56	67	81	98	117	26	31	37	45	54	65	78			
1.2	54	64	76	92	111	134	160	40	48	57	69	83	100	120	27	32	38	46	55	67	80			
1.4	55	65	78	94	114	137	165	41	49	58	70	85	103	123	27	33	39	47	57	69	82			
1.6	56	66	79	96	116	141	169	42	50	59	72	87	105	126	28	33	40	48	58	70	84			
1.8	57	68	81	98	119	144	173	43	51	61	74	89	106	129	29	34	41	49	60	72	86			
2.0	58	69	83	100	122	147	177	44	52	62	75	91	110	132	29	35	41	50	61	74	88			
2.2	59	70	85	102	124	150	181	44	53	63	77	93	113	135	30	35	42	51	62	75	90			
2.4	60	72	86	105	127	153	184	45	54	65	78	95	115	138	30	36	43	52	63	77	92			
2.6	61	73	88	107	129	156	188	46	55	66	80	97	117	141	31	37	44	53	65	78	94			
2.8	62	74	89	109	132	159	191	47	56	67	81	99	119	143	31	37	45	54	66	80	96			
3.0	63	76	91	111	134	162	195	47	57	68	83	101	122	146	32	38	46	55	67	81	97			

*Although units did not appear in the original tables, units are min-mg/L

Guidance Manual LTIESWTR Disinfection Profiling and Benchmarking, U.S. Environmental Protection Agency, 2003.

CT VALUES* FOR
4-LOG INACTIVATION OF VIRUSES BY FREE CHLORINE

Temperature (°C)	pH	
	6-9	10
0.5	12	90
5	8	60
10	6	45
15	4	30
20	3	22
25	2	15

*Although units did not appear in the original tables, units are min-mg/L

Guidance Manual LTIESWTR Disinfection Profiling and Benchmarking, U.S. Environmental Protection Agency, 2003.

Energy

Energy Sources and Conversion Processes

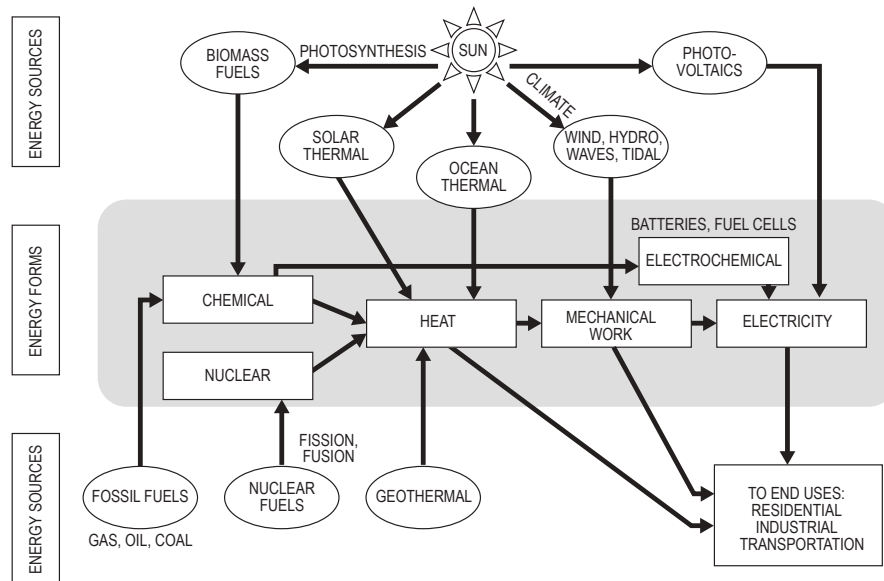

Tester, Jefferson W., Elizabeth M. Drake, Michael J. Driscoll, Michael W. Golay, and William A. Peters, *Sustainable Energy: Choosing Among Options*, MIT Press, 2012, p.12.

Combustion

Combustible Substance	Reaction	Mols	lb (kg)*
Carbon to carbon monoxide	$C + 1/2O_2 = CO$	$1 + 1/2 = 1$	$12 + 16 = 28$
Carbon to carbon dioxide	$C + O_2 = CO_2$	$1 + 1 = 1$	$12 + 16 = 28$
Carbon monoxide to carbon dioxide	$CO + 1/2O_2 = CO_2$	$1 + 1/2 = 1$	$28 + 16 = 44$
Hydrogen	$H_2 + 1/2O_2 = H_2O$	$1 + 1/2 = 1$	$2 + 16 = 18$
Sulfur to sulfur dioxide	$S + O_2 = SO_2$	$1 + 1 = 1$	$32 + 32 = 64$
Sulfur to sulfur trioxide	$S + 3/2O_2 = SO_3$	$1 + 2/2 = 1$	$32 + 48 = 80$
Methane	$CH_4 + 2O_2 = CO_2 + 2H_2O$	$1 + 2 = 1 + 2$	$16 + 64 = 44 + 36$
Ethane	$C_2H_6 + 7/2O_2 = 2CO_2 + 3H_2O$	$1 + 7/2 = 2 + 3$	$30 + 112 = 88 + 54$
Propane	$C_3H_8 + 5O_2 = 3CO_2 + 4H_2O$	$1 + 5 = 3 + 4$	$44 + 160 = 132 + 72$
Butane	$C_4H_{10} + 13/2O_2 = 4CO_2 + 5H_2O$	$1 + 12/2 = 4 + 5$	$58 + 208 = 176 + 90$
Acetylene	$C_2H_2 + 5/2O_2 = 2CO_2 + H_2O$	$1 + 5/2 = 2 + 2$	$26 + 80 = 88 + 18$
Ethylene	$C_2H_4 + 3O_2 = 2CO_2 + 2H_2O$	$1 + 3 = 2 + 2$	$28 + 96 = 88 + 36$

*Substitute the molecular weights in the reaction equation to secure lb (kg). The lb (kg) on each side of the equation must balance.

Hicks, Tyler G., *Handbook of Energy Engineering Calculations*, New York: McGraw-Hill, 2012.

Biomass as an Energy Source

Some, but not all, possible combinations of inputs and processes:

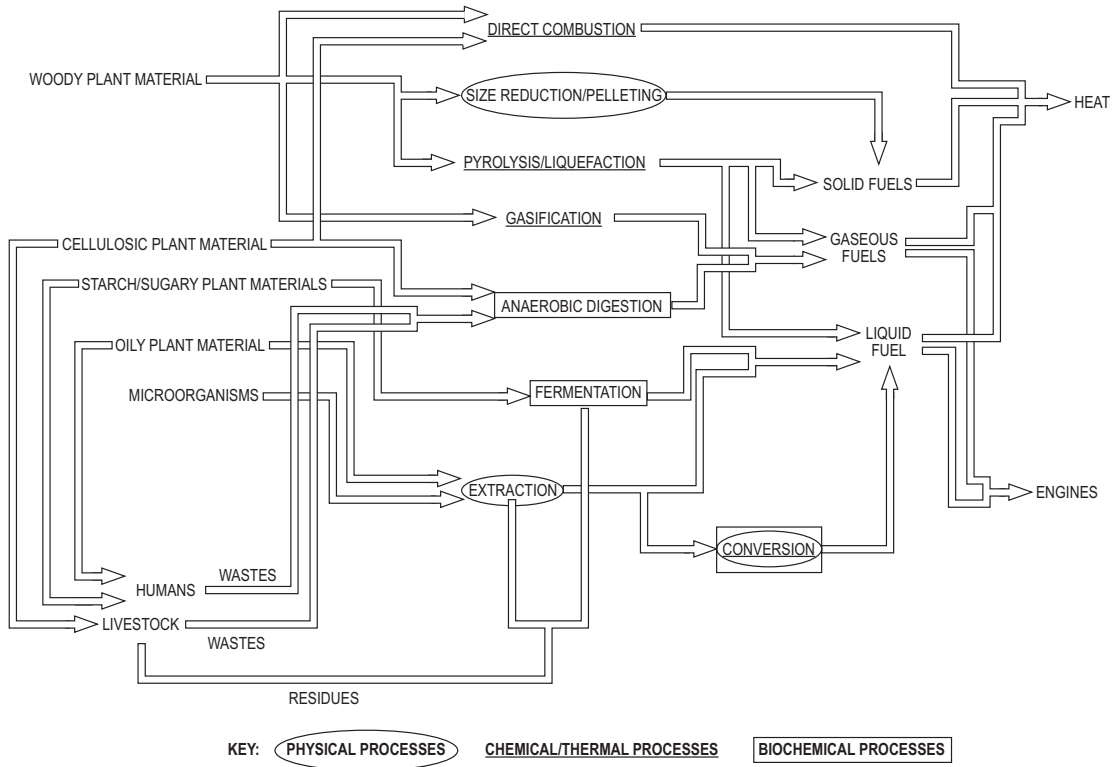

Adapted from Boyle, Godfrey, ed., *Renewable Energy: Power for a Sustainable Future*, 3rd ed., Oxford University Press, 2012, p. 127.

Hydropower

$$P = 10 \times Q \times H$$

where

P = power delivered by water (kW)

H = effective head (height in meters through which water falls)

Q = flow rate (m³/sec through plant)

Nuclear

Nuclear Power Reactor Characteristics

Reactor Type	Typical Thermal Efficiency, %	Typical Power Density, Thermal kW/ft ³ (MW/m ³)	Typical Reactor Pressure, lb/in ² (gauge) (kPa)		Average Heat Flux, Btu/(h-ft ²) (MW/m ²)	Typical Fuel Enrichment, %	Reactor Coolant
Pressurized-water	36	1,600 (56.5)	1,500	(10,341)	300,000 (945.6)	1.5–30	Light water
Boiling-water	22–30	800 (28.3)	1,000	(6,894)	100,000 (315.2)	1.5	Light water
Gas-cooled	30	200 (7.1)	600–1,000	(4,136–6,894)	—	0.70–2.5	Carbon dioxide
Liquid-metal	33	300 (10.6)	100	(689.4)	—	—	Sodium, bismuth, lead, etc.
Fast-breeder	32	20,000 (706.5)	100	(689.4)	650,000 (2,049)	—	Sodium
Fluid-fueled	30	400 (14.1)	1,000–2,000	(6,894–13,788)	Varies (varies)	Varies	Reactor fuel solution

Hicks, Tyler G., *Handbook of Energy Engineering Calculations*, New York: McGraw-Hill, 2012, Section 1.9.

Wind

The energy contained in the wind is its kinetic energy:

$$\text{Kinetic energy} = \frac{1}{2}mv^2$$

where

m = mass (kilograms)

v = wind speed (meters/second)

Noise of Different Activities Compared with Wind Turbines

Source/Activity	Noise Level in dB(A)*
Threshold of pain	140
Jet aircraft at 250 m	105
Pneumatic drill at 7 m	95
Truck at 48 km·h ⁻¹ (30 mph) at 100 m	65
Busy general office	60
Car at 64 km·h ⁻¹ (40 mph) at 100 m	55
Wind farm at 350 m	35–45
Quiet bedroom	20
Rural night-time background	20–40
Threshold of hearing	0

*dB(A): decibels (acoustically weighted to take into account that the human ear is not equally sensitive to all frequencies)

Hydraulic Turbine Operating Regimes

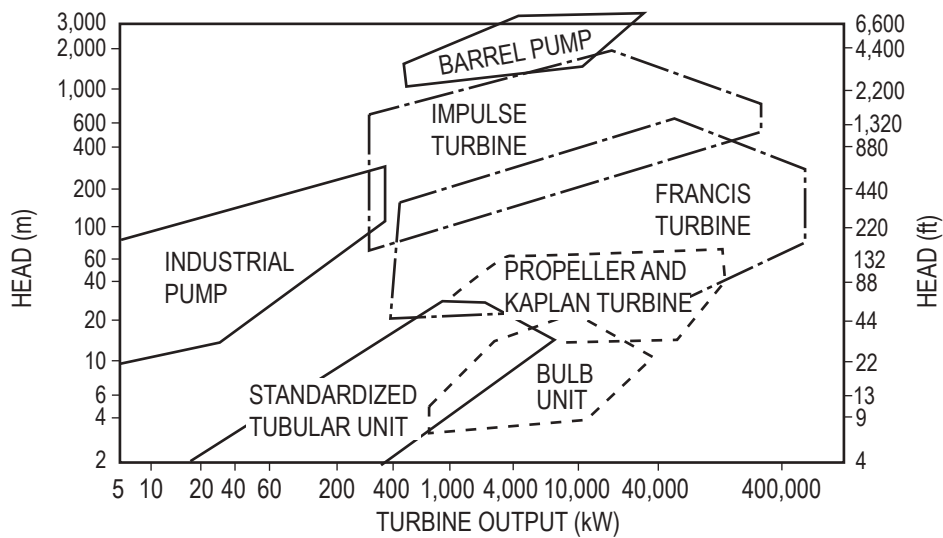

Hicks, Tyler G., *Handbook of Energy Engineering Calculations*, New York: McGraw-Hill, 2012, Section 6.3.

Solar

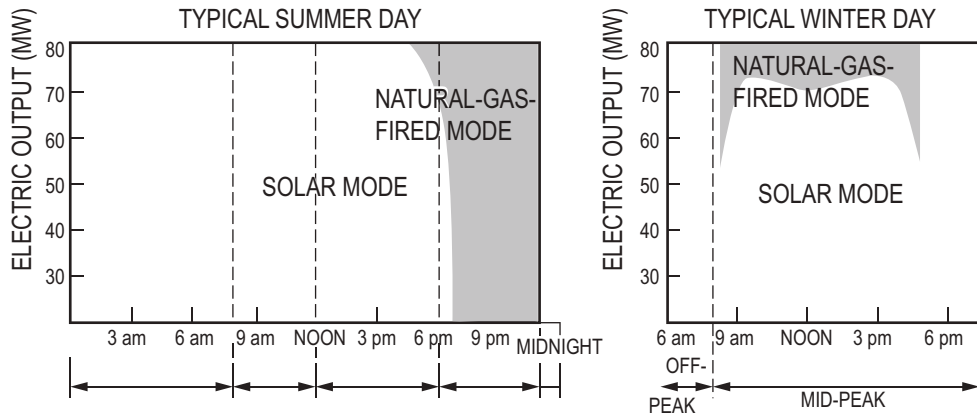

Note: Correlation of solar generation to peaking power requirements

Hicks, Tyler G., *Handbook of Energy Engineering Calculations*, New York: McGraw-Hill, 2012, Section 8.4.

Spacing of Solar Flat-Plate Collectors to Avoid Shadowing

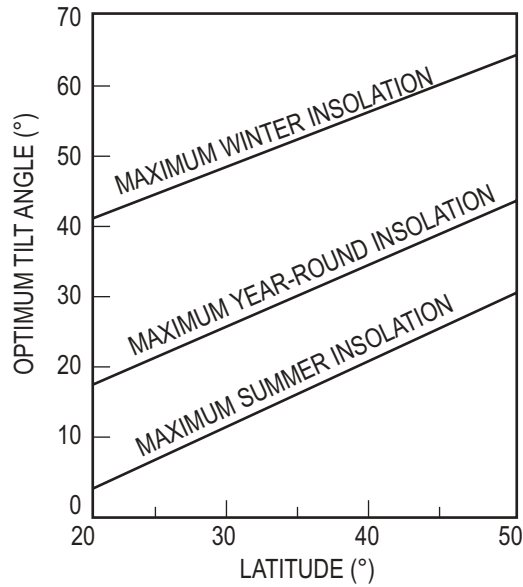

Hicks, Tyler G., *Handbook of Energy Engineering Calculations*, New York: McGraw-Hill, 2012, Section 8.9.

Wastes with Fuel Value

Industrial Wastes

	Average Heating Value (as fired)	
	Btu/lb	kJ/kg
Waste gases:		
Coke-oven	19,700	45,900
Blast-furnace	1,139	2,654
Carbon monoxide	579	1,349
Liquids:		
Refinery	21,800	50,794
Industrial sludge	3,700–4,200	8,621–9,786
Black liquor	4,400	10,252
Sulfite liquor	4,200	9,786
Dirty solvents	10,000–16,000	23,300–37,280
Spent lubricants	10,000–14,000	23,300–32,620
Paints and resins	6,000–10,000	13,980–23,300
Oily waste and residue	18,000	41,940
Solids:		
Bagasse	3,600–6,500	8,388–15,145
Bark	4,500–5,200	10,485–12,116
General wood waste	4,500–6,500	10,485–15,145
Sawdust and shavings	4,500–7,500	10,485–17,475
Coffee grounds	4,900–6,500	11,417–15,145
Nut hulls	7,700	17,941
Rice hulls	5,200–6,500	12,116–15,145
Corn cobs	8,000–8,300	18,640–19,339

Municipal Solid Wastes (MSW)

Typical Heating Value of MSW Components

Component	Energy (Btu/lb)	
	Range	Typical
Food wastes	1,500–3,000	2,000
Paper	5,000–8,000	7,200
Cardboard	6,000–7,500	7,000
Plastics	12,000–16,000	14,000
Textiles	6,500–8,000	7,500
Rubber	9,000–12,000	10,000
Leather	6,500–8,500	7,500
Garden trimmings	1,000–8,000	2,800
Wood	7,500–8,500	8,000
Glass	50–100	60
Tin cans	100–500	300
Nonferrous metals	–	–
Ferrous metals	100–500	300
Dirt, ashes, brick, etc.	1,000–5,000	3,000
Municipal solid wastes	4,000–6,500	4,500

Tchobanoglous, George, Hilary Theisen, and Rolf Eliassen, *Solid Wastes: Engineering Principles and Management Issues*, New York: McGraw-Hill, 1977, p. 62.

Greenhouse Gases: Global Warming Potential

Table data referenced to the Updated Decay Response for the Bern Carbon Cycle Model and Future CO₂ Atmospheric Concentrations Held Constant at Current Levels

Species ^a	Chemical Formula	Lifetime (years)	Global Warming Potential (Time Horizon)		
			30 years	100 years	500 years
CO ₂	CO ₂	variable ^b	1	1	1
Methane ^c	CH ₄	12±3	56	21	6.5
Nitrous Oxide	N ₂ O	120	280	310	170
HFC-23	CHF ₃	264	9,100	11,700	9,800
HFC-32	CH ₂ F ₂	5.6	2,100	650	200
HFC-41	CH ₃ F	3.7	490	150	45
HFC-43-10mee	C ₅ H ₂ F ₁₀	17.1	3,000	1,300	400
HFC-125	C ₂ HF ₅	32.6	4,600	2,800	920
HFC-134	C ₂ H ₂ F ₄	10.6	2,900	1,000	310
HFC-134a	CH ₂ FCF ₃	14.6	3,400	1,300	420
HFC-152a	C ₂ H ₄ F ₂	1.5	460	140	42
HFC-143	C ₂ H ₃ F ₃	3.8	1,000	300	94
HFC-143a	C ₂ H ₃ F ₃	48.3	5,000	3,800	1,400
HFC-227ea	C ₃ HF ₇	36.5	4,300	2,900	950
HFC-236fa	C ₃ H ₂ F ₆	209	5,100	6,300	4,700
HFC-245ca	C ₃ H ₃ F ₅	6.6	1,800	560	170
Sulfur hexafluoride	SF ₆	3,200	16,300	23,900	34,900
Perfluoromethane	CF ₄	50,000	4,400	6,500	10,000
Perfluoroethane	C ₂ F ₆	10,000	6,200	9,200	14,000
Perfluoropropane	C ₃ F ₈	2,600	4,800	7,000	10,100
Perfluorobutane	C ₄ F ₁₀	2,600	4,800	7,000	10,100
Perfluorocyclobutane	c-C ₄ F ₈	3,200	6,000	8,700	12,700
Perfluoropentane	C ₅ F ₁₂	4,100	5,100	7,500	11,000
Perfluorohexane	C ₆ F ₁₄	3,200	5,000	7,400	10,700
Ozone-depleting substances, ^d e.g., CFCs and HCFCs					

^aWater vapor has been omitted because of its shorter average residence time in the atmosphere (i.e., about 7 days).

^bDerived from the Bern carbon cycle model.

^cThe global warming potential (GWP) for methane includes indirect effects of tropospheric ozone production and stratospheric water vapor production.

^dThe GWPs for ozone-depleting substances (including all CFCs, HCFCs, and halons, whose direct GWPs have been given in previous reports) are a sum of a direct (positive) component and an indirect (negative) component which depends strongly upon the effectiveness of each substance for ozone destruction. Generally, the halons are likely to have negative net GWPs, while those of the CFCs are likely to be positive over both 20- and 100- year time horizons.

Sustainability

Carbon emission factors

$$\frac{GDP}{P} = \text{per capita gross domestic product (\$/person-yr)}$$

$$\frac{E}{GDP} = \text{energy consumption per GDP; energy intensity (Btu/\$)}$$

$$\frac{CO_2}{E} = \text{carbon emission per unit of energy} \left(\frac{CO_2 \text{ emitted}}{\text{Btu}} \right)$$

where P = population (persons)

Sustainability Impact (SI)

$$SI = P \times \frac{GDP}{P} \times \frac{E}{GDP}$$

Kaya's Emission Equation

$$E_{\text{carbon}} = P \times \frac{GDP}{P} \times \frac{E}{GDP} \times \frac{CO_2}{E}$$

Electrical and Computer Engineering

Units

The basic electrical units are coulombs for charge, volts for voltage, amperes for current, ohms for resistance and impedance, and siemens for conductance and admittance.

Electrostatics

$$\mathbf{F}_2 = \frac{Q_1 Q_2}{4\pi\epsilon r^2} \mathbf{a}_{r12}$$

where

\mathbf{F}_2 = force on charge 2 due to charge 1

Q_i = the i th point charge

r = distance between charges 1 and 2

\mathbf{a}_{r12} = a unit vector directed from 1 to 2

ϵ = permittivity of the medium

For free space or air:

$$\epsilon = \epsilon_0 = 8.85 \times 10^{-12} \text{ farads/meter}$$

Electrostatic Fields

Electric field intensity \mathbf{E} (volts/meter) at point 2 due to a point charge Q_1 at point 1 is

$$\mathbf{E} = \frac{Q_1}{4\pi\epsilon r^2} \mathbf{a}_{r12}$$

For a line charge of density ρ_L coulombs/meter on the z -axis, the radial electric field is

$$\mathbf{E}_L = \frac{\rho_L}{2\pi\epsilon r} \mathbf{a}_r$$

For a sheet charge of density ρ_s coulombs/meter² in the x - y plane:

$$\mathbf{E}_s = \frac{\rho_s}{2\epsilon} \mathbf{a}_z, z > 0$$

Gauss' law states that the integral of the electric flux density $\mathbf{D} = \epsilon\mathbf{E}$ over a closed surface is equal to the charge enclosed or

$$Q_{encl} = \oint_S \epsilon \mathbf{E} \cdot d\mathbf{S}$$

The force on a point charge Q in an electric field with intensity \mathbf{E} is $\mathbf{F} = Q\mathbf{E}$.

The work done by an external agent in moving a charge Q in an electric field from point p_1 to point p_2 is

$$W = -Q \int_{p_1}^{p_2} \mathbf{E} \cdot d\mathbf{l}$$

The energy W_E stored in an electric field \mathbf{E} is

$$W_E = (1/2) \iiint_V \epsilon |\mathbf{E}|^2 dV$$

Voltage

The potential difference V between two points is the work per unit charge required to move the charge between the points.

For two parallel plates with potential difference V , separated by distance d , the strength of the E field between the plates is

$$E = \frac{V}{d}$$

directed from the + plate to the – plate.

Current

Electric current $i(t)$ through a surface is defined as the rate of charge transport through that surface or

$$i(t) = dq(t)/dt, \text{ which is a function of time } t$$

since $q(t)$ denotes instantaneous charge.

A constant current $i(t)$ is written as I , and the vector current density in amperes/m² is defined as \mathbf{J} .

Magnetic Fields

For a current-carrying wire on the z -axis

$$\mathbf{H} = \frac{\mathbf{B}}{\mu} = \frac{I\mathbf{a}_\phi}{2\pi r}$$

where

\mathbf{H} = magnetic field strength (amperes/meter)

\mathbf{B} = magnetic flux density (tesla)

\mathbf{a}_ϕ = unit vector in positive ϕ direction in cylindrical coordinates

I = current

μ = permeability of the medium

For air: $\mu = \mu_0 = 4\pi \times 10^{-7}$ H/m

Force on a current-carrying conductor in a uniform magnetic field is

$$\mathbf{F} = I\mathbf{L} \times \mathbf{B}$$

where \mathbf{L} = length vector of a conductor

The energy stored W_H in a magnetic field \mathbf{H} is

$$W_H = (1/2) \iiint_V \mu |\mathbf{H}|^2 dv$$

Induced Voltage

Faraday's Law states for a coil of N turns enclosing flux ϕ :

$$v = -N d\phi/dt$$

where

v = induced voltage

ϕ = average flux (webers) enclosed by each turn

$$\phi = \int_S \mathbf{B} \cdot d\mathbf{S}$$

Resistivity

For a conductor of length L , electrical resistivity ρ , and cross-sectional area A , the resistance is

$$R = \frac{\rho L}{A}$$

For metallic conductors, the resistivity and resistance vary linearly with changes in temperature according to the following relationships:

$$\rho = \rho_0 [1 + \alpha(T - T_0)]$$

and

$$R = R_0 [1 + \alpha(T - T_0)]$$

where

ρ_0 = resistivity at T_0

R_0 = resistance at T_0

α = temperature coefficient

Ohm's Law: $V = IR$; $v(t) = i(t) R$

Resistors in Series and Parallel

For series connections, the current in all resistors is the same and the equivalent resistance for n resistors in series is

$$R_S = R_1 + R_2 + \dots + R_n$$

For parallel connections of resistors, the voltage drop across each resistor is the same and the equivalent resistance for n resistors in parallel is

$$R_P = 1 / (1/R_1 + 1/R_2 + \dots + 1/R_n)$$

For two resistors R_1 and R_2 in parallel

$$R_P = \frac{R_1 R_2}{R_1 + R_2}$$

Power Absorbed by a Resistive Element

$$P = VI = \frac{V^2}{R} = I^2 R$$

Kirchhoff's Laws

Kirchhoff's voltage law for a closed path is expressed by

$$\sum V_{\text{rises}} = \sum V_{\text{drops}}$$

Kirchhoff's current law for a closed surface is

$$\sum I_{\text{in}} = \sum I_{\text{out}}$$

Source Equivalents

For an arbitrary circuit



The Thévenin equivalent is

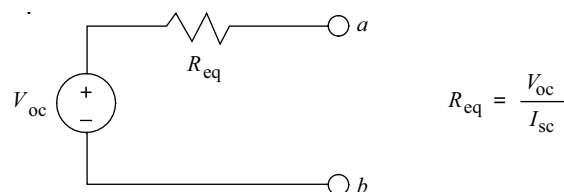

The open circuit voltage V_{oc} is $V_a - V_b$, and the short circuit current is I_{sc} from a to b .

The Norton equivalent circuit is

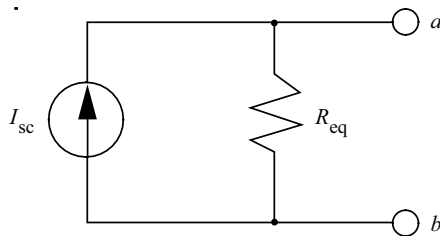

where I_{sc} and R_{eq} are defined above.

A load resistor R_L connected across terminals a and b will draw maximum power when $R_L = R_{eq}$.

Capacitors and Inductors

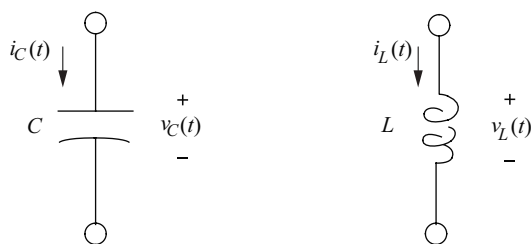

The charge $q_C(t)$ and voltage $v_C(t)$ relationship for a capacitor C in farads is

$$C = q_C(t)/v_C(t) \quad \text{or} \quad q_C(t) = Cv_C(t)$$

A parallel plate capacitor of area A with plates separated a distance d by an insulator with a permittivity ϵ has a capacitance

$$C = \frac{\epsilon A}{d}$$

ϵ is often given as $\epsilon = \epsilon_r(\epsilon_0)$ where ϵ_r is the relative permittivity or dielectric constant and $\epsilon_0 = 8.85 \times 10^{-12}$ F/m.

The current-voltage relationships for a capacitor are

$$v_C(t) = v_C(0) + \frac{1}{C} \int_0^t i_C(\tau) d\tau$$

$$\text{and } i_C(t) = C(dv_C/dt)$$

The energy stored in a capacitor is expressed in joules and given by

$$\text{Energy} = Cv_C^2/2 = q_C^2/2C = q_Cv_C/2$$

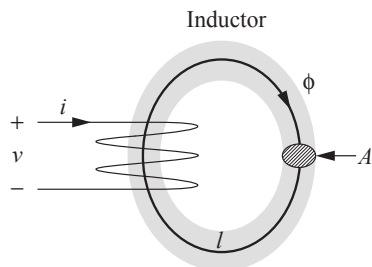

The inductance L (henrys) of a coil of N turns wound on a core with cross-sectional area A (m^2), permeability μ and flux ϕ with a mean path of l (m) is given as:

$$L = N^2 \mu A / l = N^2 / \mathfrak{R}$$

$$N\phi = Li$$

where \mathfrak{R} = reluctance = $l/\mu A$ (H^{-1}).

μ is sometimes given as $\mu = \mu_r \cdot \mu_o$ where μ_r is the relative permeability and $\mu_o = 4\pi \times 10^{-7}$ H/m.

Using Faraday's law, the voltage-current relations for an inductor are

$$v_L(t) = L (di_L/dt)$$

$$i_L(t) = i_L(0) + \frac{1}{L} \int_0^t v_L(\tau) d\tau$$

where

v_L = inductor voltage

L = inductance (henrys)

i_L = inductor current (amperes)

The energy stored in an inductor is expressed in joules and given by

$$\text{Energy} = Li_L^2/2$$

Capacitors and Inductors in Parallel and Series

Capacitors in Parallel

$$C_P = C_1 + C_2 + \dots + C_n$$

Capacitors in Series

$$C_S = \frac{1}{1/C_1 + 1/C_2 + \dots + 1/C_n}$$

Inductors in Parallel

$$L_P = \frac{1}{1/L_1 + 1/L_2 + \dots + 1/L_n}$$

Inductors in Series

$$L_S = L_1 + L_2 + \dots + L_n$$

AC Circuits

For a sinusoidal voltage or current of frequency f (Hz) and period T (seconds),

$$f = 1/T = \omega/(2\pi)$$

where ω = the angular frequency in radians/s

Average Value

For a periodic waveform (either voltage or current) with period T ,

$$X_{\text{ave}} = (1/T) \int_0^T x(t) dt$$

The average value of a full-wave rectified sinusoid is

$$X_{\text{ave}} = (2X_{\text{max}})/\pi$$

and half this for half-wave rectification, where

$$X_{\text{max}} = \text{the peak amplitude of the sinusoid.}$$

Effective or RMS Values

For a periodic waveform with period T , the rms or effective value is

$$X_{\text{eff}} = X_{\text{rms}} = \left[(1/T) \int_0^T x^2(t) dt \right]^{1/2}$$

For a sinusoidal waveform and full-wave rectified sine wave,

$$X_{\text{eff}} = X_{\text{rms}} = X_{\text{max}}/\sqrt{2}$$

For a half-wave rectified sine wave,

$$X_{\text{eff}} = X_{\text{rms}} = X_{\text{max}}/2$$

For a periodic signal,

$$X_{\text{rms}} = \sqrt{X_{\text{dc}}^2 + \sum_{n=1}^{\infty} X_n^2}$$

where

$$X_{\text{dc}} = \text{dc component of } x(t)$$

$$X_n = \text{rms value of the } n\text{th harmonic}$$

Sine-Cosine Relations and Trigonometric Identities

$$\cos(\omega t) = \sin(\omega t + \pi/2) = -\sin(\omega t - \pi/2)$$

$$\sin(\omega t) = \cos(\omega t - \pi/2) = -\cos(\omega t + \pi/2)$$

Other trigonometric identities for sinusoids are given in the section on Trigonometry.

Phasor Transforms of Sinusoids

$$P[V_{\text{max}}\cos(\omega t + \phi)] = V_{\text{rms}}\angle\phi = \mathbf{V}$$

$$P[I_{\text{max}}\cos(\omega t + \theta)] = I_{\text{rms}}\angle\theta = \mathbf{I}$$

For a circuit element, the impedance is defined as the ratio of phasor voltage to phasor current.

$$\mathbf{Z} = \frac{\mathbf{V}}{\mathbf{I}} = R + jX$$

where

$$R = \text{resistance}$$

$$X = \text{reactance}$$

The admittance is defined as the ratio of phasor current to phasor voltage or the inverse of impedance.

$$\mathbf{Y} = \frac{\mathbf{I}}{\mathbf{V}} = \frac{1}{\mathbf{Z}} = G + jB$$

where

G = conductance

B = susceptance

Circuit Element	Impedance	Resistance	Reactance	Admittance	Conductance	Susceptance
Resistor	R	R	0	$\frac{1}{R}$	$\frac{1}{R}$	0
Capacitor	$\frac{1}{j\omega C}$	0	$-\frac{1}{\omega C}$	$j\omega C$	0	ωC
Inductor	$j\omega L$	0	ωL	$\frac{1}{j\omega L}$	0	$-\frac{1}{\omega L}$

Impedances in series combine additively while those in parallel combine as the reciprocal of the sum of reciprocals, just as in the case of resistors.

Admittances in series combine as the reciprocal of the sum of reciprocals while those in parallel combine additively.

Maximum Power-Transfer Theorem

DC Circuits

Maximum power transfer to the load R_L occurs when $R_L = R_{Th}$.

$$P_{\max} = \frac{V_{Th}^2}{4 R_{Th}}$$

$$\text{Efficiency: } \eta = \frac{P_L}{P_S} = \frac{R_L}{R_L + R_{Th}}$$

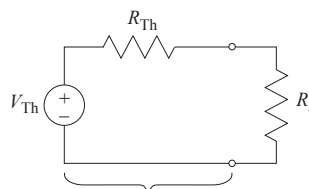

Thevenin Equivalent Circuit

AC Circuits

In an ac circuit maximum power transfer to the load impedance Z_L occurs when the load impedance equals the complex conjugate of the Thevenin equivalent impedance:

$$Z_L = Z_{Th}^*$$

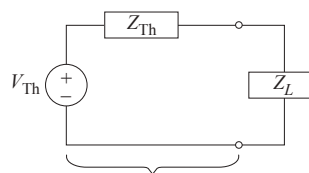

Thevenin Equivalent Circuit

*If the load is purely resistive (R_L) then for maximum power transfer $R_L = |Z_{Th}|$

RC and RL Transients

$$\begin{aligned}
 t \geq 0; v_C(t) &= v_C(0)e^{-t/RC} + V(1 - e^{-t/RC}) \\
 i(t) &= \left\{ [V - v_C(0)]/R \right\} e^{-t/RC} \\
 v_R(t) &= i(t)R = [V - v_C(0)]e^{-t/RC}
 \end{aligned}$$

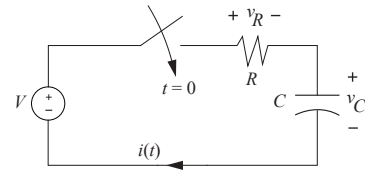

$$\begin{aligned}
 t \geq 0; i(t) &= i(0)e^{-Rt/L} + \frac{V}{R}(1 - e^{-Rt/L}) \\
 v_R(t) &= i(t)R = i(0)Re^{-Rt/L} + V(1 - e^{-Rt/L}) \\
 v_L(t) &= L(di/dt) = -i(0)Re^{-Rt/L} + Ve^{-Rt/L}
 \end{aligned}$$

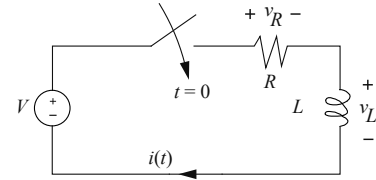

$$\begin{aligned}
 t \geq 0; v_C(t) &= v_R(t) = Ve^{-t/RC} \\
 i_R(t) &= -i_C(t) = \frac{V}{R}e^{-t/RC}
 \end{aligned}$$

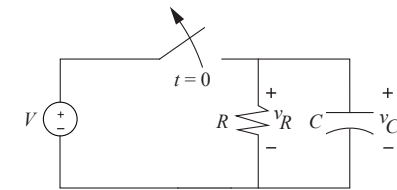

where $v(0)$ and $i(0)$ denote the initial conditions and the parameters RC and L/R are termed the respective circuit time constants.

Resonance

The radian resonant frequency for both parallel and series resonance situations is

$$\omega_0 = \frac{1}{\sqrt{LC}} = 2\pi f_0 \text{ rad/s}$$

Series Resonance

$$\begin{aligned}
 \omega_0 L &= \frac{1}{\omega_0 C} \\
 Z &= R \text{ at resonance} \\
 Q &= \frac{\omega_0 L}{R} = \frac{1}{\omega_0 CR} \\
 BW &= \frac{\omega_0}{Q} \text{ rad/s}
 \end{aligned}$$

Parallel Resonance

$$\begin{aligned}
 \omega_0 L &= \frac{1}{\omega_0 C} \\
 Z &= R \text{ at resonance} \\
 Q &= \omega_0 RC = \frac{R}{\omega_0 L} \\
 BW &= \frac{\omega_0}{Q} \text{ rad/s}
 \end{aligned}$$

AC Power

Complex Power

Real power P (watts) is defined by

$$\begin{aligned} P &= (\tfrac{1}{2})V_{\max} I_{\max} \cos \theta \\ &= V_{\text{rms}} I_{\text{rms}} \cos \theta \end{aligned}$$

where θ is the angle measured from \mathbf{V} to \mathbf{I} . If \mathbf{I} leads \mathbf{V} , then the power factor (pf),

$$pf = \cos \theta$$

is said to be a leading pf .

If \mathbf{I} lags \mathbf{V} , then the power factor (pf) is said to be a lagging pf .

Reactive power Q (vars) is defined by

$$\begin{aligned} Q &= (\tfrac{1}{2})V_{\max} I_{\max} \sin \theta \\ &= V_{\text{rms}} I_{\text{rms}} \sin \theta \end{aligned}$$

Complex power \mathbf{S} (volt-amperes) is defined by

$$\mathbf{S} = \mathbf{VI}^* = P + jQ,$$

where \mathbf{I}^* is the complex conjugate of the phasor current.

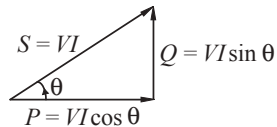

Complex Power Triangle (Inductive Load)

For resistors, $\theta = 0$, so the real power is

$$P = V_{\text{rms}} I_{\text{rms}} = V_{\text{rms}}^2 / R = I_{\text{rms}}^2 R$$

Balanced Three-Phase (3- ϕ) Systems

The 3-phase line-phase relations are

for a delta	for a wye
$V_L = V_P$	$V_L = \sqrt{3} V_P = \sqrt{3} V_{LN}$
$I_L = \sqrt{3} I_P$	$I_L = I_P$

where subscripts L and P denote line and phase respectively.

A balanced 3- ϕ , delta-connected load impedance can be converted to an equivalent wye-connected load impedance using the following relationship

$$\mathbf{Z}_{\Delta} = 3\mathbf{Z}_Y$$

The following formulas can be used to determine 3- ϕ power for balanced systems.

$$\begin{aligned} \mathbf{S} &= P + jQ \\ |\mathbf{S}| &= 3V_P I_P = \sqrt{3} V_L I_L \\ \mathbf{S} &= 3V_P I_P^* = \sqrt{3} V_L I_L^* (\cos \theta_P + j \sin \theta_P) \end{aligned}$$

For balanced 3- ϕ , wye- and delta-connected loads

$$\mathbf{S} = \frac{V_L^2}{Z_Y^*} \quad \mathbf{S} = 3 \frac{V_L^2}{Z_\Delta^*}$$

where

- \mathbf{S} = total 3- ϕ complex power (VA)
- $|\mathbf{S}|$ = total 3- ϕ apparent power (VA)
- P = total 3- ϕ real power (W)
- Q = total 3- ϕ reactive power (var)
- θ_P = power factor angle of each phase
- V_L = rms value of the line-to-line voltage
- V_{LN} = rms value of the line-to-neutral voltage
- I_L = rms value of the line current
- I_P = rms value of the phase current

For a 3- ϕ , wye-connected source or load with line-to-neutral voltages and a positive phase sequence

$$\begin{aligned} \mathbf{V}_{an} &= V_P \angle 0^\circ \\ \mathbf{V}_{bn} &= V_P \angle -120^\circ \\ \mathbf{V}_{cn} &= V_P \angle 120^\circ \end{aligned}$$

The corresponding line-to-line voltages are

$$\begin{aligned} \mathbf{V}_{ab} &= \sqrt{3} V_P \angle 30^\circ \\ \mathbf{V}_{bc} &= \sqrt{3} V_P \angle -90^\circ \\ \mathbf{V}_{ca} &= \sqrt{3} V_P \angle 150^\circ \end{aligned}$$

Transformers (Ideal)

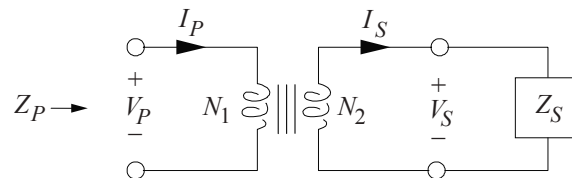

Turns Ratio

$$\begin{aligned} a &= N_1/N_2 \\ a &= \left| \frac{\mathbf{V}_P}{\mathbf{V}_S} \right| = \left| \frac{\mathbf{I}_S}{\mathbf{I}_P} \right| \end{aligned}$$

The impedance seen at the input is

$$\mathbf{Z}_P = a^2 \mathbf{Z}_S$$

Three-Phase Transformer Connection Diagrams

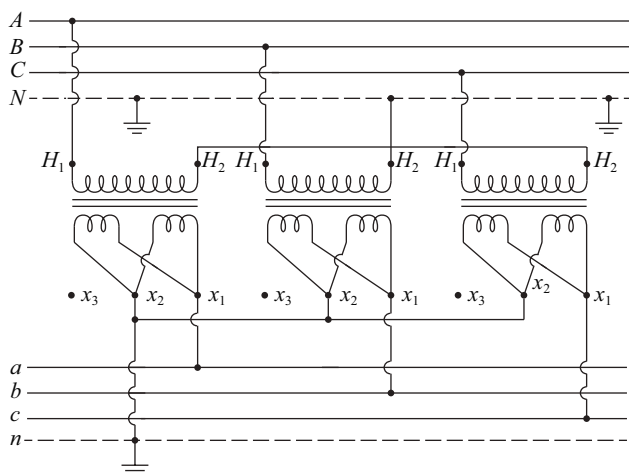

(A)
WYE-WYE CONNECTION

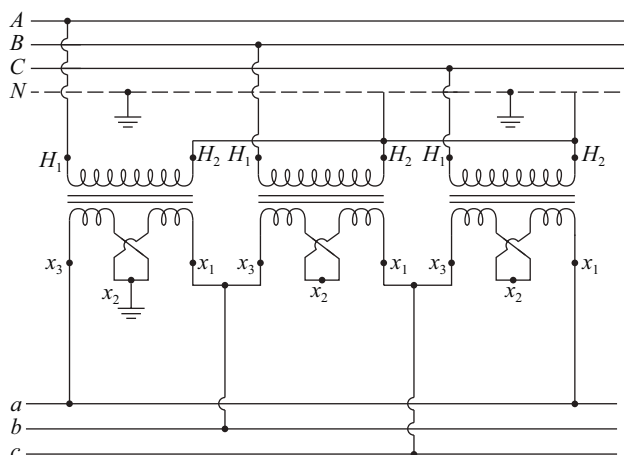

(B)
WYE-DELTA CONNECTION

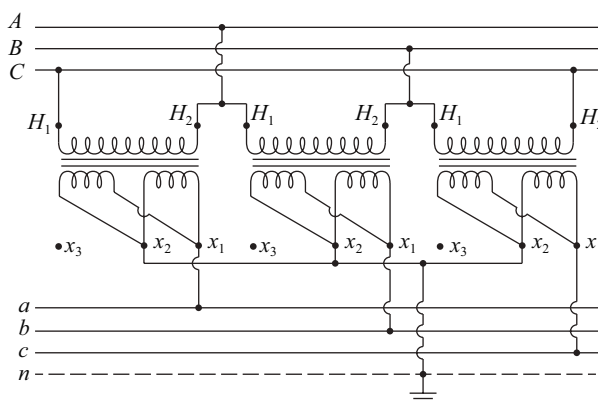

(C)
DELTA-WYE CONNECTION

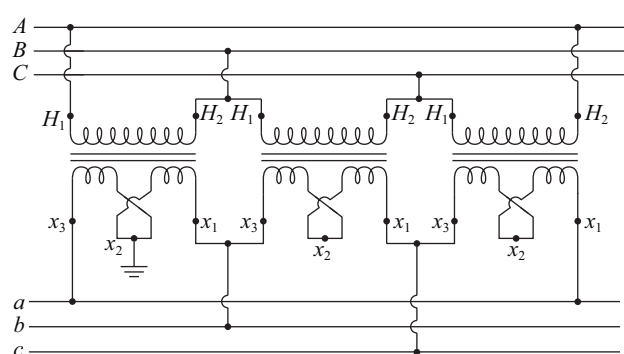

(D)
DELTA-DELTA CONNECTION

Gonen, Turan, *Electric Power Distribution Engineering*, 3rd ed., Boca Raton, Florida: CRC Press, 2014.

Rotating Machines (General)

Efficiency of a machine is defined as:

$$\eta = P_{out}/P_{in}$$

where

P_{out} = power output of the machine (W)

P_{in} = power input to the machine (W)

For a motor, P_{in} is the active component of the electrical input power and P_{out} is the mechanical output power. For a generator, vice versa.

The losses in a machine can be attributed to core, copper, friction and windage, and stray losses, and:

$$P_{out} = P_{in} - P_{loss}$$

Mechanical power in a rotating machine is given by:

$$P = T\omega_m$$

where

P = mechanical power (W)

T = mechanical torque (N•m)

ω_m = angular velocity (rad/s)

The angular velocity in rad/s is related to the speed in rpm by:

$$\omega_m = (2\pi/60)n$$

where n is the rotor's speed in rpm.

AC Machines

The synchronous speed n_s for ac motors is given by

$$n_s = 120f/p$$

where

f = the line voltage frequency (Hz)

p = the number of poles

The slip for an induction motor is

$$\text{slip} = (n_s - n)/n_s$$

where n = the rotational speed (rpm)

Synchronous Machines

The single-phase equivalent circuit of a Y-connected synchronous machine is shown below. The induced voltage is $E_a = E_a \angle \delta$ where the magnitude is proportional to the excitation (e.g., field current) and the angle δ is the torque or power angle. The direction for the current I_a is shown for a generator in this circuit. The resistance R_a is the armature circuit resistance and the reactance X_s is the synchronous reactance.

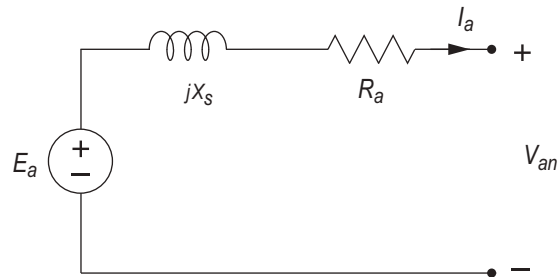

The power developed by the synchronous machine is:

$$P_d = 3E_a I_a \cos(\delta + \theta)$$

where θ is the power factor angle when the terminal voltage V_{an} is used as the reference.

If the armature resistance is negligible, the power developed by the synchronous machine is:

$$P_d = 3(E_a V_a / X_s) \sin \delta$$

and maximum power capability of the synchronous machine is:

$$P_d = 3(E_a V_a / X_s)$$

Induction Machines

The slip s of an induction machine is defined as:

$$s = (n_s - n)/n_s$$

where

n_s = synchronous speed (rpm)

n = speed of the rotor (rpm)

A sample torque-speed characteristic of an induction motor is shown below.

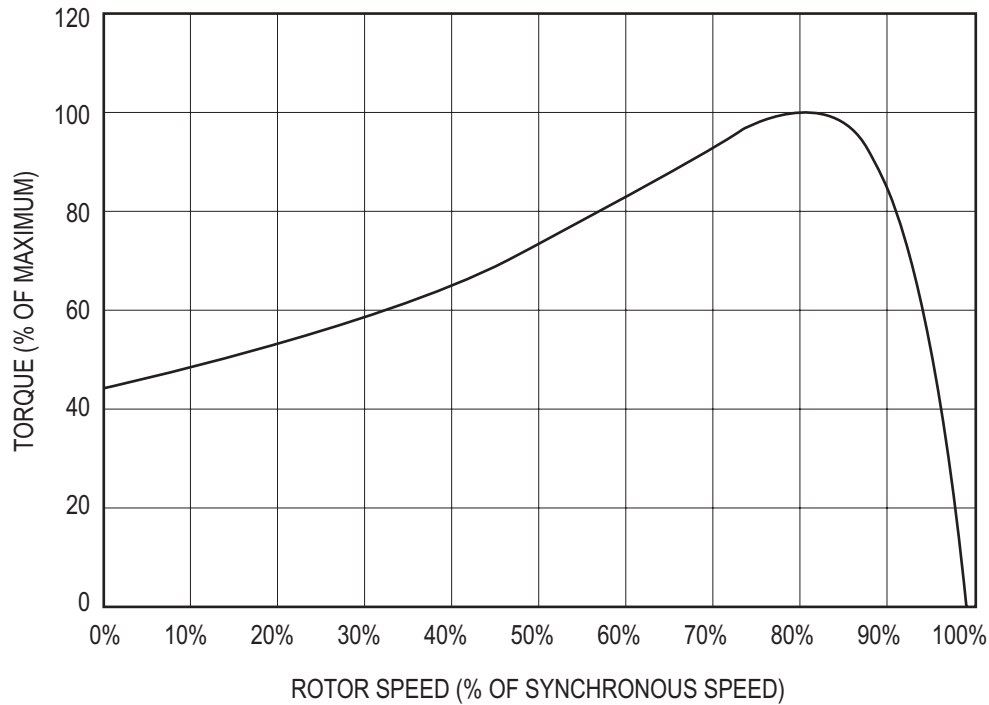

DC Machines

The electrical input power (motor) or output power (generator) of the armature circuit is given by:

$$P = V_T I_a$$

where

V_T = armature circuit terminal voltage

I_a = armature current

The armature circuit of a dc machine is approximated by a series connection of the armature resistance R_a , the armature inductance L_a , and a dependent voltage source of value

$$V_a = K_a n \phi \text{ volts}$$

where

K_a = constant depending on the design

n = armature speed (rpm)

ϕ = magnetic flux generated by the field

The field circuit is approximated by the field resistance R_f in series with the field inductance L_f . Neglecting saturation, the magnetic flux generated by the field current I_f is

$$\phi = K_f I_f \text{ webers}$$

The mechanical power generated by the armature is

$$P_m = V_a I_a \text{ watts}$$

where I_a is the armature current.

The mechanical torque produced is

$$T_m = (60/2\pi) K_a \phi I_a \text{ newton-meters}$$

Servomotors and Generators

Servomotors are electrical motors tied to a feedback system to obtain precise control. Smaller servomotors typically are dc motors.

A permanent magnet dc generator can be used to convert mechanical energy to electrical energy, as in a tachometer.

DC motor suppliers may provide data sheets with speed torque curves, motor torque constants (K_T), and motor voltage constants (K_E). An idealized dc motor at steady state exhibits the following relationships:

$$V = IR + K_E \omega$$

$$T = K_T I$$

where

V = voltage at the motor terminals

I = current through the motor

T = torque applied by the motor

R = resistance of the windings

ω = rotational speed

When using consistent SI units [$N\cdot m/A$ and $V/(\text{rad}/s)$], $K_T = K_E$.

An ideal speed-torque curve for a servomotor, with constant V , would look like this:

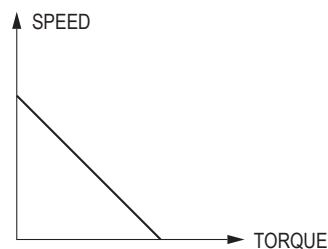

Voltage Regulation

The percent voltage regulation of a power supply is defined as

$$\% \text{ Regulation} = \frac{|V_{NL}| - |V_{FL}|}{|V_{FL}|} \times 100\%$$

where

V_{NL} = voltage under no load conditions

V_{FL} = voltage under full load conditions (assumes that the source voltage remains constant)

Electromagnetic Dynamic Fields

The integral and point form of Maxwell's equations are

$$\oint \mathbf{E} \cdot d\ell = - \iint_S (\partial \mathbf{B} / \partial t) \cdot d\mathbf{S}$$

$$\oint \mathbf{H} \cdot d\ell = I_{\text{enc}} + \iint_S (\partial \mathbf{D} / \partial t) \cdot d\mathbf{S}$$

$$\oiint_{S_V} \mathbf{D} \cdot d\mathbf{S} = \iiint_V \rho \, dv$$

$$\oiint_{S_V} \mathbf{B} \cdot d\mathbf{S} = 0$$

$$\nabla \times \mathbf{E} = -\partial \mathbf{B} / \partial t$$

$$\nabla \times \mathbf{H} = \mathbf{J} + \partial \mathbf{D} / \partial t$$

$$\nabla \cdot \mathbf{D} = \rho$$

$$\nabla \cdot \mathbf{B} = 0$$

Lossless Transmission Lines

The wavelength, λ , of a sinusoidal signal is defined as the distance the signal will travel in one period.

$$\lambda = \frac{U}{f}$$

where

U = velocity of propagation

f = frequency of the sinusoid

The characteristic impedance, Z_0 , of a transmission line is the input impedance of an infinite length of the line and is given by

$$Z_0 = \sqrt{L/C}$$

where L and C are the per unit length inductance and capacitance of the line.

The reflection coefficient at the load is defined as

$$\Gamma = \frac{V^-}{V^+} = \frac{Z_L - Z_0}{Z_L + Z_0}$$

and the standing wave ratio SWR is

$$SWR = \frac{1 + |\Gamma|}{1 - |\Gamma|}$$

β = Propagation constant = $\frac{2\pi}{\lambda}$

For sinusoidal voltages and currents:

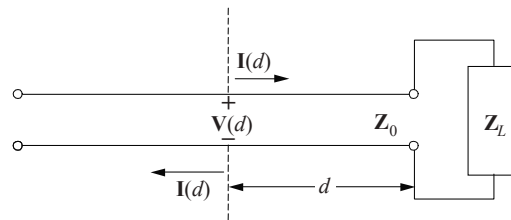

Voltage across the transmission line:

$$V(d) = V^+ e^{j\beta d} + V^- e^{-j\beta d}$$

Current along the transmission line:

$$I(d) = I^+ e^{j\beta d} + I^- e^{-j\beta d}$$

where $I^+ = V^+/Z_0$ and $I^- = -V^-/Z_0$

Input impedance at d

$$Z_{in}(d) = Z_0 \frac{Z_L + jZ_0 \tan(\beta d)}{Z_0 + jZ_L \tan(\beta d)}$$

Difference Equations

Difference equations are used to model discrete systems. Systems which can be described by difference equations include computer program variables iteratively evaluated in a loop, sequential circuits, cash flows, recursive processes, systems with time-delay components, etc. Any system whose input $x(t)$ and output $y(t)$ are defined only at the equally spaced intervals $t = kT$ can be described by a difference equation.

First-Order Linear Difference Equation

A first-order difference equation is

$$y[k] + a_1 y[k-1] = x[k]$$

Second-Order Linear Difference Equation

A second-order difference equation is

$$y[k] + a_1 y[k-1] + a_2 y[k-2] = x[k]$$

z-Transforms

The transform definition is

$$F(z) = \sum_{k=0}^{\infty} f[k] z^{-k}$$

The inverse transform is given by the contour integral

$$f[k] = \frac{1}{2\pi j} \oint_{\Gamma} F(z) z^{k-1} dz$$

and it represents a powerful tool for solving linear shift-invariant difference equations. A limited unilateral list of z-transform pairs assuming zero initial conditions follows:

$f[k]$	$F(z)$
$\delta[k]$, Impulse at $k = 0$	1
$u[k]$, Step at $k = 0$	$1/(1 - z^{-1})$
β^k	$1/(1 - \beta z^{-1})$
$y[k-1]$	$z^{-1}Y(z)$
$y[k-2]$	$z^{-2}Y(z)$
$y[k+1]$	$zY(z) - zy[0]$
$y[k+2]$	$z^2Y(z) - z^2y[0] - zy[1]$
$\sum_{m=0}^{\infty} x[k-m]h[m]$	$H(z)X(z)$
$\lim_{k \rightarrow 0} f[k]$	$\lim_{z \rightarrow \infty} F(z)$
$\lim_{k \rightarrow \infty} f[k]$	$\lim_{z \rightarrow 1} (1 - z^{-1})F(z)$

[Note: The last two transform pairs represent the Initial Value Theorem (I.V.T.) and the Final Value Theorem (F.V.T.) respectively.]

Convolution

Continuous-time convolution:

$$v(t) = x(t) * y(t) = \int_{-\infty}^{\infty} x(\tau)y(t - \tau) d\tau$$

Discrete-time convolution:

$$v[n] = x[n] * y[n] = \sum_{k=-\infty}^{\infty} x[k]y[n - k]$$

Digital Signal Processing

A discrete-time, linear, time-invariant (DTLTI) system with a single input $x[n]$ and a single output $y[n]$ can be described by a linear difference equation with constant coefficients of the form

$$y[n] + \sum_{i=1}^k b_i y[n-i] = \sum_{i=0}^l a_i x[n-i]$$

If all initial conditions are zero, taking a z-transform yields a transfer function

$$H(z) = \frac{Y(z)}{X(z)} = \frac{\sum_{i=0}^l a_i z^{-i}}{1 + \sum_{i=1}^k b_i z^{-i}}$$

Two common discrete inputs are the unit-step function $u[n]$ and the unit impulse function $\delta[n]$, where

$$u[n] = \begin{cases} 0 & n < 0 \\ 1 & n \geq 0 \end{cases} \quad \text{and} \quad \delta[n] = \begin{cases} 1 & n = 0 \\ 0 & n \neq 0 \end{cases}$$

The impulse response $h[n]$ is the response of a discrete-time system to $x[n] = \delta[n]$.

A finite impulse response (FIR) filter is one in which the impulse response $h[n]$ is limited to a finite number of points:

$$h[n] = \sum_{i=0}^k a_i \delta[n-i]$$

The corresponding transfer function is given by

$$H(z) = \sum_{i=0}^k a_i z^{-i}$$

where k is the order of the filter.

An infinite impulse response (IIR) filter is one in which the impulse response $h[n]$ has an infinite number of points:

$$h[n] = \sum_{i=0}^{\infty} a_i \delta[n-i]$$

Communication Theory and Concepts

The following concepts and definitions are useful for communications systems analysis.

Functions

Unit step, $u(t)$	$u(t) = \begin{cases} 0 & t < 0 \\ 1 & t > 0 \end{cases}$
Rectangular pulse, $\Pi(t/\tau)$	$\Pi(t/\tau) = \begin{cases} 1 & t/\tau < \frac{1}{2} \\ 0 & t/\tau > \frac{1}{2} \end{cases}$
Triangular pulse, $\Lambda(t/\tau)$	$\Lambda(t/\tau) = \begin{cases} 1 - t/\tau & t/\tau < 1 \\ 0 & t/\tau > 1 \end{cases}$
Sinc, $\text{sinc}(at)$	$\text{sinc}(at) = \frac{\sin(a\pi t)}{a\pi t}$
Unit impulse, $\delta(t)$	$\int_{-\infty}^{+\infty} x(t+t_0)\delta(t)dt = x(t_0)$ <p style="text-align: center;">for every $x(t)$ defined and continuous at $t = t_0$. This is equivalent to</p> $\int_{-\infty}^{+\infty} x(t)\delta(t-t_0)dt = x(t_0)$

$$\begin{aligned} x(t) * h(t) &= \int_{-\infty}^{+\infty} x(\lambda)h(t-\lambda)d\lambda \\ &= h(t) * x(t) = \int_{-\infty}^{+\infty} h(\lambda)x(t-\lambda)d\lambda \end{aligned}$$

In particular,

$$x(t) * \delta(t-t_0) = x(t-t_0)$$

The Fourier Transform and its Inverse

$$\begin{aligned} X(f) &= \int_{-\infty}^{+\infty} x(t)e^{-j2\pi ft} dt \\ x(t) &= \int_{-\infty}^{+\infty} X(f)e^{j2\pi ft} df \end{aligned}$$

$x(t)$ and $X(f)$ form a *Fourier transform pair*:

$$x(t) \leftrightarrow X(f)$$

Frequency Response and Impulse Response

The *frequency response* $H(f)$ of a system with input $x(t)$ and output $y(t)$ is given by

$$H(f) = \frac{Y(f)}{X(f)}$$

This gives

$$Y(f) = H(f)X(f)$$

The response $h(t)$ of a linear time-invariant system to a unit-impulse input $\delta(t)$ is called the *impulse response* of the system. The response $y(t)$ of the system to any input $x(t)$ is the convolution of the input $x(t)$ with the impulse response $h(t)$:

$$\begin{aligned} y(t) &= x(t) * h(t) = \int_{-\infty}^{+\infty} x(\lambda) h(t - \lambda) d\lambda \\ &= h(t) * x(t) = \int_{-\infty}^{+\infty} h(\lambda) x(t - \lambda) d\lambda \end{aligned}$$

Therefore, the impulse response $h(t)$ and frequency response $H(f)$ form a Fourier transform pair:

$$h(t) \leftrightarrow H(f)$$

Parseval's Theorem

The total energy in an energy signal (finite energy) $x(t)$ is given by

$$E = \int_{-\infty}^{+\infty} |x(t)|^2 dt = \int_{-\infty}^{+\infty} |X(f)|^2 df$$

Parseval's Theorem for Fourier Series

A periodic signal $x(t)$ with period T_0 and fundamental frequency $f_0 = 1/T_0 = \omega_0/2\pi$ can be represented by a complex-exponential Fourier series

$$x(t) = \sum_{n=-\infty}^{n=+\infty} X_n e^{jn2\pi f_0 t}$$

The average power in the dc component and the first N harmonics is

$$P = \sum_{n=-N}^{n=+N} |X_n|^2 = X_0^2 + 2 \sum_{n=0}^{n=N} |X_n|^2$$

The total average power in the periodic signal $x(t)$ is given by *Parseval's theorem*:

$$P = \frac{1}{T_0} \int_{t_0}^{t_0 + T_0} |x(t)|^2 dt = \sum_{n=-\infty}^{n=+\infty} |X_n|^2$$

Decibels and Bode Plots

Decibels is a technique to measure the ratio of two powers:

$$\text{dB} = 10 \log_{10} (P_2/P_1)$$

The definition can be modified to measure the ratio of two voltages:

$$\text{dB} = 20 \log_{10} (V_2/V_1)$$

Bode plots use a logarithmic scale for the frequency when plotting magnitude and phase response, where the magnitude is plotted in dB using a straight-line (asymptotic) approximation.

The information below summarizes Bode plots for several terms commonly encountered when determining voltage gain, $G_v(j\omega)$. Since logarithms are used to convert gain to decibels, the decibel response when these various terms are multiplied together can be added to determine the overall response.

Term	Magnitude Response $ G_v(j\omega) _{\text{dB}}$	Phase Response $\angle G_v(j\omega)$	Plot
K_0	$20 \log_{10}(K_0)$	0°	a
$(j\omega)^{\pm 1}$	$\pm 20 \log_{10}(\omega)$	$\pm 90^\circ$	b & c
$(1 + j\omega/\omega_c)^{\pm 1}$	0 for $\omega \ll \omega_c$ $\pm 3 \text{ dB}$ for $\omega = \omega_c$ $\pm 20 \log_{10}(\omega)$ for $\omega \gg \omega_c$	0° for $\omega \ll \omega_c$ $\pm 45^\circ$ for $\omega = \omega_c$ $\pm 90^\circ$ for $\omega \gg \omega_c$	d & e

(a) K_0

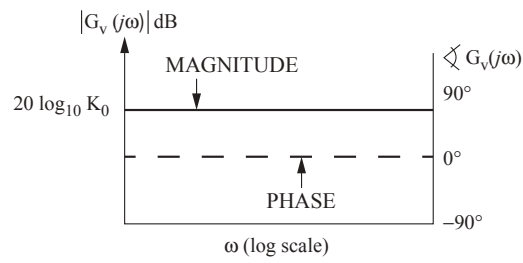

(b) $(j\omega)$

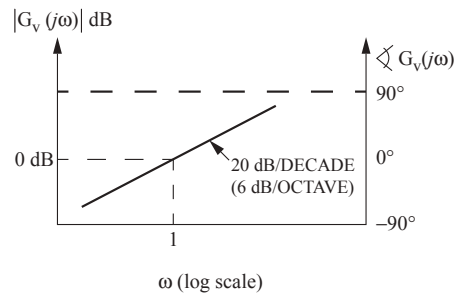

(c) $(j\omega)^{-1}$

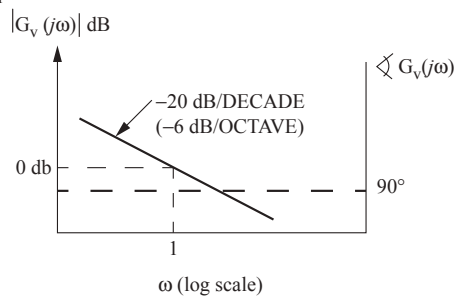

(d) $(1 + j\omega/\omega_c)$

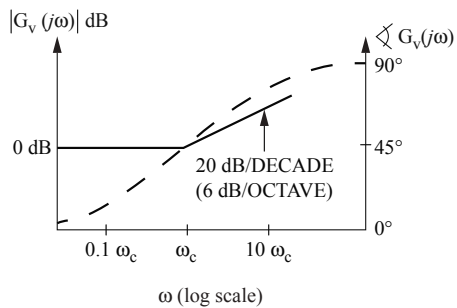

(e) $(1 + j\omega/\omega_c)^{-1}$

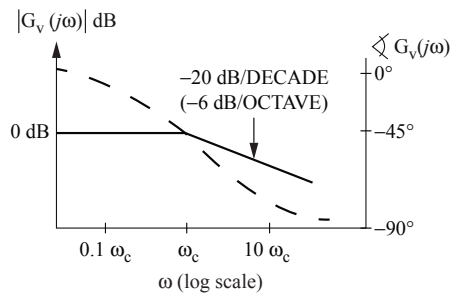

Amplitude Modulation (AM)

$$\begin{aligned} x_{AM}(t) &= A_c [A + m(t)] \cos(2\pi f_c t) \\ &= A'_c [1 + am_n(t)] \cos(2\pi f_c t) \end{aligned}$$

The *modulation index* is a , and the normalized message is

$$m_n(t) = \frac{m(t)}{\max|m(t)|}$$

The *efficiency* η is the percent of the total transmitted power that contains the message.

$$\eta = \frac{a^2 \langle m_n^2(t) \rangle}{1 + a^2 \langle m_n^2(t) \rangle} 100 \text{ percent}$$

where the mean-squared value or normalized average power in $m_n(t)$ is

$$\langle m_n^2(t) \rangle = \lim_{T \rightarrow \infty} \frac{1}{2T} \int_{-T}^{+T} |m_n(t)|^2 dt$$

If $M(f) = 0$ for $|f| > W$, then the *bandwidth* of $x_{AM}(t)$ is $2W$.

AM signals can be demodulated with an envelope detector or a synchronous demodulator.

Double-Sideband Modulation (DSB)

$$x_{DSB}(t) = A_c m(t) \cos(2\pi f_c t)$$

If $M(f) = 0$ for $|f| > W$, then the bandwidth of $m(t)$ is W and the bandwidth of $x_{DSB}(t)$ is $2W$. DSB signals must be demodulated with a synchronous demodulator. A Costas loop is often used.

Single-Sideband Modulation (SSB)

Lower Sideband:

$$x_{LSB}(t) \leftrightarrow X_{LSB}(f) = X_{DSB}(f) \Pi\left(\frac{f}{2f_c}\right)$$

Upper Sideband:

$$x_{USB}(t) \leftrightarrow X_{USB}(f) = X_{DSB}(f) \left[1 - \Pi\left(\frac{f}{2f_c}\right)\right]$$

In either case, if $M(f) = 0$ for $|f| > W$, then the bandwidth of $x_{LSB}(t)$ or of $x_{USB}(t)$ is W . SSB signals can be demodulated with a synchronous demodulator or by carrier reinsertion and envelope detection.

Angle Modulation

$$x_{Ang}(t) = A_c \cos[2\pi f_c t + \phi(t)]$$

The *phase deviation* $\phi(t)$ is a function of the message $m(t)$.

The *instantaneous phase* is

$$\phi_i(t) = 2\pi f_c t + \phi(t) \text{ rad}$$

The *instantaneous frequency* is

$$\omega_i(t) = \frac{d}{dt} \phi_i(t) = 2\pi f_c + \frac{d}{dt} \phi(t) \text{ rad/s}$$

The *frequency deviation* is

$$\Delta\omega(t) = \frac{d}{dt} \phi(t) \text{ rad/s}$$

The *phase deviation* is

$$\phi(t) = k_p m(t) \text{ rad}$$

The *complete* bandwidth of an angle-modulated signal is infinite.

A discriminator or a phase-lock loop can demodulate angle-modulated signals.

Frequency Modulation (FM)

The *phase deviation* is

$$\phi(t) = k_F \int_{-\infty}^t m(\lambda) d\lambda \text{ rad}$$

The *frequency-deviation ratio* is

$$D = \frac{k_F \max |m(t)|}{2\pi W}$$

where W is the message bandwidth. If $D \ll 1$ (narrowband FM), the 98% power bandwidth B is

$$B \cong 2W$$

If $D > 1$, (wideband FM) the 98% power bandwidth B is given by *Carson's rule*:

$$B \cong 2(D + 1)W$$

Sampled Messages

A low-pass message $m(t)$ can be exactly reconstructed from uniformly spaced samples taken at a sampling frequency of $f_s = 1/T_s$

$$f_s > 2W \text{ where } M(f) = 0 \text{ for } f > W$$

The frequency $2W$ is called the *Nyquist frequency*. Sampled messages are typically transmitted by some form of pulse modulation. The minimum bandwidth B required for transmission of the pulse modulated message is inversely proportional to the pulse length τ .

$$B \propto \frac{1}{\tau}$$

Frequently, for approximate analysis

$$B \cong \frac{1}{2\tau}$$

is used as the *minimum* bandwidth of a pulse of length τ .

Ideal-Impulse Sampling

$$\begin{aligned} x_{\delta}(t) &= m(t) \sum_{n=-\infty}^{n=+\infty} \delta(t - nT_s) = \sum_{n=-\infty}^{n=+\infty} m(nT_s) \delta(t - nT_s) \\ X_{\delta}(f) &= M(f) * \left[f_s \sum_{k=-\infty}^{k=+\infty} \delta(f - kf_s) \right] \\ &= f_s \sum_{k=-\infty}^{k=+\infty} M(f - kf_s) \end{aligned}$$

The message $m(t)$ can be recovered from $x_{\delta}(t)$ with an ideal low-pass filter of bandwidth W if $f_s > 2W$.

(PAM) Pulse-Amplitude Modulation—Natural Sampling

A PAM signal can be generated by multiplying a message by a pulse train with pulses having duration τ and period

$$T_s = 1/f_s$$

$$x_N(t) = m(t) \sum_{n=-\infty}^{n=+\infty} \Pi\left[\frac{t - nT_s}{\tau}\right] = \sum_{n=-\infty}^{n=+\infty} m(t) \Pi\left[\frac{t - nT_s}{\tau}\right]$$

$$X_N(f) = \tau f_s \sum_{k=-\infty}^{k=+\infty} \text{sinc}(k\tau f_s) M(f - kf_s)$$

The message $m(t)$ can be recovered from $x_N(t)$ with an ideal low-pass filter of bandwidth W .

Pulse-Code Modulation (PCM)

PCM is formed by sampling a message $m(t)$ and digitizing the sample values with an A/D converter. For an n -bit binary word length, transmission of a pulse-code-modulated low-pass message $m(t)$, with $M(f) = 0$ for $f \geq W$, requires the transmission of at least $2nW$ binary pulses per second. A binary word of length n bits can represent q quantization levels:

$$q = 2^n$$

The minimum bandwidth required to transmit the PCM message will be

$$B \propto 2nW = 2W \log_2 q$$

Error Coding

Error coding is a method of detecting and correcting errors that may have been introduced into a frame during data transmission. A system that is capable of detecting errors may be able to detect single or multiple errors at the receiver based on the error coding method. Below are a few examples of error detecting error coding methods.

Parity – For parity bit coding, a parity bit value is added to the transmitted frame to make the total number of ones odd (odd parity) or even (even parity). Parity bit coding can detect single bit errors.

Cyclical Redundancy Code (CRC) – CRC can detect multiple errors. To generate the transmitted frame from the receiver, the following equation is used:

$$T(x)/G(x) = E(x)$$

where

$$T(x) = \text{frame}$$

$$G(x) = \text{generator}$$

$$E(x) = \text{remainder}$$

The transmitted code is $T(x) + E(x)$

On the receiver side, if

$$[T(x) + E(x)]/G(x) = 0$$

then no errors were detected.

To detect and correct errors, redundant bits need to be added to the transmitted data. Some error detecting and correcting algorithms include block code, Hamming code, and Reed Solomon.

Delays in Computer Networks

Transmission Delay – The time it takes to transmit the bits in the packet on the transmission link:

$$d_{\text{trans}} = L/R$$

where

L = packet size (bits/packet)

R = rate of transmission (bits/sec)

Propagation Delay – The time taken for a bit to travel from one end of the link to the other:

$$d_{\text{prop}} = d/s$$

where

d = distance or length of the link

s = propagation speed

The propagation speed is usually somewhere between the speed of light c and $2/3 c$.

Nodal Processing Delay – It takes time to examine the packet's header and determine where to direct the packet to its destination.

Queueing Delay – The packet may experience delay as it waits to be transmitted onto the link. Ignoring nodal and queueing delays, the round-trip delay of delivering a packet from one node to another in the stop-and-wait system is

$$D = 2 d_{\text{prop}} + d_{\text{transAck}} + d_{\text{transData}}$$

Because the sending host must wait until the ACK packet is received before sending another packet, this leads to a very poor utilization, U , of resources for stop-and-wait links with relatively large propagation delays:

$$U = d_{\text{trans}}/D$$

For this reason, for paths with large propagation delays, most computer networking systems use a pipelining system called go-back- N , in which N packets are transmitted in sequence before the transmitter receives an ACK for the first packet.

Automatic Request for Retransmission (ARQ)

Links in the network are most often twisted pair, optical fiber, coaxial cable, or wireless channels. These are all subject to errors and are often unreliable. The ARQ system is designed to provide reliable communications over these unreliable links. In ARQ, each packet contains an error detection process (at the link layer). If no errors are detected in the packet, the host (or intermediate switch) transmits a positive acknowledgement (ACK) packet back to the transmitting element indicating that the packet was received correctly. If any error is detected, the receiving host (or switch) automatically discards the packet and sends a negative acknowledgement (NAK) packet back to the originating element (or stays silent, allowing the transmitter to timeout). Upon receiving the NAK packet or by the trigger of a timeout, the transmitting host (or switch) retransmits the message packet that was in error. A diagram of a simple stop-and-wait ARQ system with a positive acknowledgement is shown below.

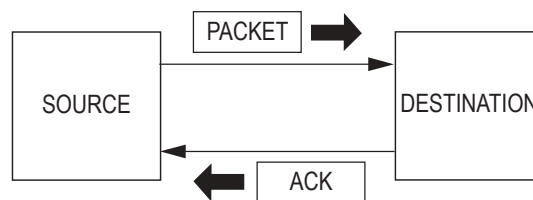

Transmission Algorithms

Sliding window protocol is used where delivery of data is required while maximizing channel capacity. In the sliding window protocol, each outbound frame contains a sequence number. When the transmitted frame is received, the receiver is required to transmit an ACK for each received frame before an additional frame can be transmitted. If the frame is not received, the receiver will transmit a NAK message indicating the frame was not received after an appropriate time has expired. Sliding window protocols automatically adjust the transmission speed to both the speed of the network and the rate at which the receiver sends new acknowledgements.

Shannon Channel Capacity Formula

$$C = BW \log_2 (1+S/N)$$

where

C = channel capacity in Hz (bits/sec)

BW = bandwidth in Hz (bits/sec)

S = power of the signal at the receiving device (watts)

N = noise power at the receiving device (watts)

$\frac{S}{N}$ = Signal to Noise Ratio

Analog Filter Circuits

Analog filters are used to separate signals with different frequency content. The following circuits represent simple analog filters used in communications and signal processing.

First-Order Low-Pass Filters

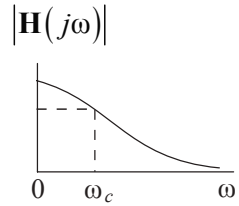

$$|\mathbf{H}(j\omega_c)| = \frac{1}{\sqrt{2}} |\mathbf{H}(0)|$$

Frequency Response

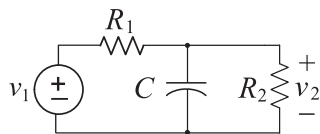

$$\mathbf{H}(s) = \frac{\mathbf{V}_2}{\mathbf{V}_1} = \frac{R_P}{R_1} \cdot \frac{1}{1 + sR_P C}$$

$$R_P = \frac{R_1 R_2}{R_1 + R_2} \quad \omega_c = \frac{1}{R_P C}$$

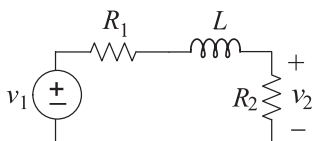

$$\mathbf{H}(s) = \frac{\mathbf{V}_2}{\mathbf{V}_1} = \frac{R_2}{R_S} \cdot \frac{1}{1 + sL/R_S}$$

$$R_S = R_1 + R_2 \quad \omega_c = \frac{R_S}{L}$$

First-Order High-Pass Filters

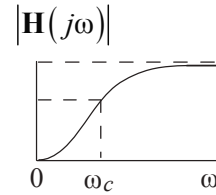

$$|\mathbf{H}(j\omega_c)| = \frac{1}{\sqrt{2}} |\mathbf{H}(j\infty)|$$

Frequency Response

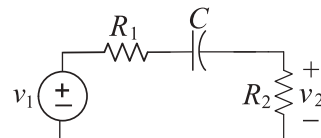

$$\mathbf{H}(s) = \frac{\mathbf{V}_2}{\mathbf{V}_1} = \frac{R_2}{R_S} \cdot \frac{sR_S C}{1 + sR_S C}$$

$$R_S = R_1 + R_2 \quad \omega_c = \frac{1}{R_S C}$$

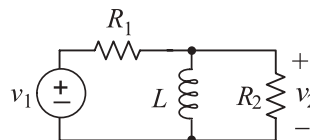

$$\mathbf{H}(s) = \frac{\mathbf{V}_2}{\mathbf{V}_1} = \frac{R_P}{R_1} \cdot \frac{sL/R_P}{1 + sL/R_P}$$

$$R_P = \frac{R_1 R_2}{R_1 + R_2} \quad \omega_c = \frac{R_P}{L}$$

Band-Pass Filters

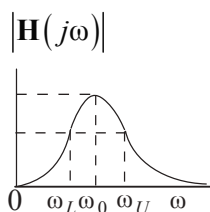

$$|\mathbf{H}(j\omega_L)| = |\mathbf{H}(j\omega_U)| = \frac{1}{\sqrt{2}} |\mathbf{H}(j\omega_0)|$$

$$\text{3-dB Bandwidth} = BW = \omega_U - \omega_L$$

Frequency Response

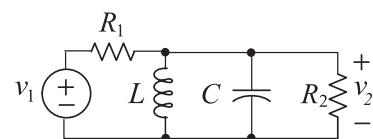

$$\mathbf{H}(s) = \frac{\mathbf{V}_2}{\mathbf{V}_1} = \frac{1}{R_1 C} \cdot \frac{s}{s^2 + s/R_p C + 1/LC}$$

$$R_p = \frac{R_1 R_2}{R_1 + R_2} \quad \omega_0 = \frac{1}{\sqrt{LC}}$$

$$|\mathbf{H}(j\omega_0)| = \frac{R_2}{R_1 + R_2} = \frac{R_p}{R_1} \quad BW = \frac{1}{R_p C}$$

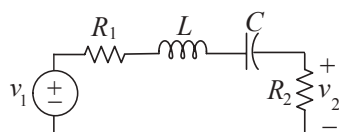

$$\mathbf{H}(s) = \frac{\mathbf{V}_2}{\mathbf{V}_1} = \frac{R_2}{L} \cdot \frac{s}{s^2 + sR_S/L + 1/LC}$$

$$R_S = R_1 + R_2 \quad \omega_0 = \frac{1}{\sqrt{LC}}$$

$$|\mathbf{H}(j\omega_0)| = \frac{R_2}{R_1 + R_2} = \frac{R_2}{R_S} \quad BW = \frac{R_S}{L}$$

Band-Reject Filters

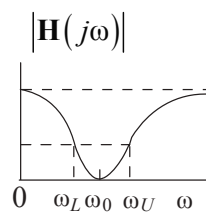

$$|\mathbf{H}(j\omega_L)| = |\mathbf{H}(j\omega_U)| = \left[1 - \frac{1}{\sqrt{2}}\right] |\mathbf{H}(0)|$$

$$\text{3-dB Bandwidth} = BW = \omega_U - \omega_L$$

Frequency Response

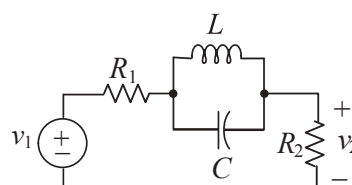

$$\mathbf{H}(s) = \frac{\mathbf{V}_2}{\mathbf{V}_1} = \frac{R_2}{R_S} \cdot \frac{s^2 + 1/LC}{s^2 + s/R_S C + 1/LC}$$

$$R_S = R_1 + R_2 \quad \omega_0 = \frac{1}{\sqrt{LC}}$$

$$|\mathbf{H}(0)| = \frac{R_2}{R_1 + R_2} = \frac{R_2}{R_S} \quad BW = \frac{1}{R_S C}$$

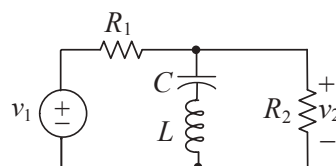

$$\mathbf{H}(s) = \frac{\mathbf{V}_2}{\mathbf{V}_1} = \frac{R_p}{R_1} \cdot \frac{s^2 + 1/LC}{s^2 + sR_p/L + 1/LC}$$

$$R_p = \frac{R_1 R_2}{R_1 + R_2} \quad \omega_0 = \frac{1}{\sqrt{LC}}$$

$$|\mathbf{H}(0)| = \frac{R_2}{R_1 + R_2} = \frac{R_p}{R_1} \quad BW = \frac{R_p}{L}$$

Operational Amplifiers

Ideal

$$v_0 = A(v_1 - v_2)$$

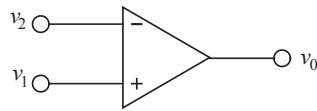

where A is large ($> 10^4$), and $v_1 - v_2$ is small enough so as not to saturate the amplifier.

For the ideal operational amplifier, assume that the input currents are zero and that the gain A is infinite so when operating linearly $v_2 - v_1 = 0$.

For the two-source configuration with an ideal operational amplifier,

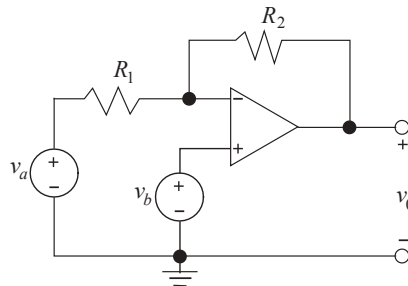

$$v_0 = -\frac{R_2}{R_1} v_a + \left(1 + \frac{R_2}{R_1}\right) v_b$$

If $v_a = 0$, we have a non-inverting amplifier with

$$v_0 = \left(1 + \frac{R_2}{R_1}\right) v_b$$

If $v_b = 0$, we have an inverting amplifier with

$$v_0 = -\frac{R_2}{R_1} v_a$$

Common Mode Rejection Ratio (CMRR)

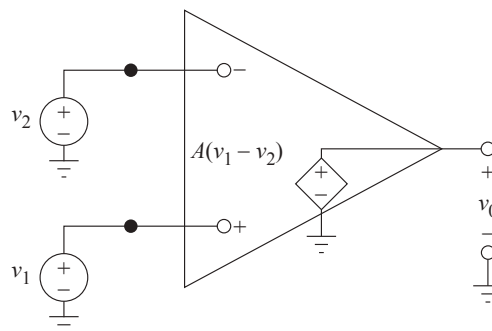

Equivalent Circuit of an Ideal Op Amp

In the op-amp circuit shown the differential input is defined as:

$$v_{id} = v_1 - v_2$$

The common-mode input voltage is defined as:

$$v_{icm} = (v_1 + v_2)/2$$

The output voltage is given by:

$$v_O = Av_{id} + A_{cm}v_{icm}$$

In an ideal op amp $A_{cm} = 0$. In a nonideal op amp the $CMRR$ is used to measure the relative degree of rejection between the differential gain and common-mode gain.

$$CMRR = \frac{|A|}{|A_{cm}|}$$

$CMRR$ is usually expressed in decibels as:

$$CMRR = 20 \log_{10} \left[\frac{|A|}{|A_{cm}|} \right]$$

Solid-State Electronics and Devices

Conductivity of a semiconductor material:

$$\sigma = q (n\mu_n + p\mu_p)$$

where

μ_n \equiv electron mobility

μ_p \equiv hole mobility

n \equiv electron concentration

p \equiv hole concentration

q \equiv charge on an electron ($1.6 \times 10^{-19}\text{C}$)

Doped material:

p -type material; $p_p \approx N_a$

n -type material; $n_n \approx N_d$

Carrier concentrations at equilibrium

$$(p)(n) = n_i^2$$

where n_i \equiv intrinsic concentration.

Built-in potential (contact potential) of a p - n junction:

$$V_0 = \frac{kT}{q} \ln \frac{N_a N_d}{n_i^2}$$

Thermal voltage

$$V_T = \frac{kT}{q} \approx 0.026 \text{ V at } 300\text{K}$$

N_a = acceptor concentration

N_d = donor concentration

T = temperature (K)

k = Boltzmann's Constant = 1.38×10^{-23} J/K

Capacitance of abrupt p - n junction diode

$$C(V) = C_0 / \sqrt{1 - V/V_{bi}}$$

C_0 = junction capacitance at $V = 0$

V = potential of anode with respect to cathode

V_{bi} = junction contact potential

Resistance of a diffused layer is $R = R_s(L/W)$

where

R_s = sheet resistance = ρ/d in ohms per square

ρ = resistivity

d = thickness

L = length of diffusion

W = width of diffusion

Differential Amplifier

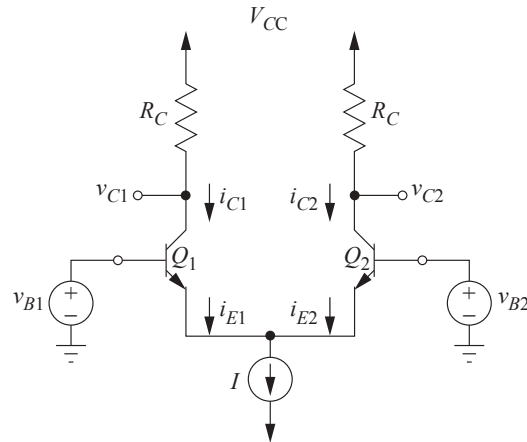

A Basic BJT Differential Amplifier

Sedra, Adel, and Kenneth Smith, *Microelectronic Circuits*, 3rd ed., ©1991, p. 408, Oxford University Press. Reproduced with permission of the Licensor through PLSclear.

A basic BJT differential amplifier consists of two matched transistors whose emitters are connected and that are biased by a constant-current source. The following equations govern the operation of the circuit given that neither transistor is operating in the saturation region.

$$\frac{i_{E1}}{i_{E2}} = e^{(v_{B1} - v_{B2})/V_T}$$

$$i_{E1} + i_{E2} = I$$

$$i_{E1} = \frac{I}{1 + e^{(v_{B2} - v_{B1})/V_T}} \quad i_{E2} = \frac{I}{1 + e^{(v_{B1} - v_{B2})/V_T}}$$

$$i_{C1} = \alpha i_{E1}$$

$$i_{C2} = \alpha i_{E2}$$

The following figure shows a plot of two normalized collector currents versus normalized differential input voltage for a circuit using transistors with $\alpha \cong 1$.

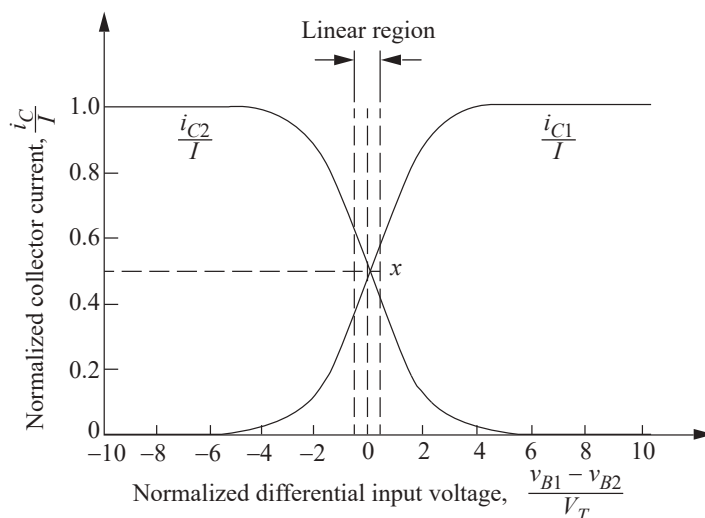

Transfer characteristics of the BJT differential amplifier with $\alpha \cong 1$

Sedra, Adel, and Kenneth Smith, *Microelectronic Circuits*, 3rd ed., ©1991, p. 412, Oxford University Press. Reproduced with permission of the Licensor through PLSclear.

Power Conversion

In the following figure, D represents the duty ratio, f represents the switching frequency, and T represents the switching period. The voltage gain of an ideal switching dc-dc converter with this gate command is:

Buck Converter: D

Boost Converter: $\frac{1}{1-D}$

Buck-Boost Converter: $-\frac{D}{1-D}$

For an n -pulse rectifier with a line-to-line RMS input voltage of V_{rms} and no output filter, the average output voltage is

$$V_{dc} = V_{rms} \times \frac{n\sqrt{2}}{\pi} \sin \frac{\pi}{n}$$

For a three-phase voltage-source inverter with an input voltage of V_{dc} and sine-triangle pulsewidth modulation with a peak modulation index of m , the line-to-line RMS fundamental output voltage is

$$V_{rms} = mV_{dc} \times \frac{1}{2} \sqrt{\frac{3}{2}}$$

This is valid for $0 \leq m \leq 1$, or with third-harmonic injection $0 \leq m \leq 1.15$.

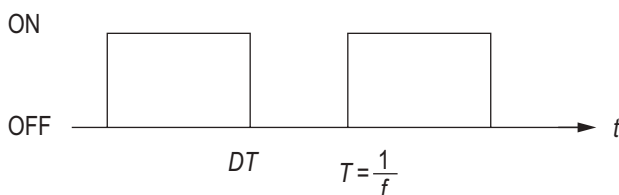

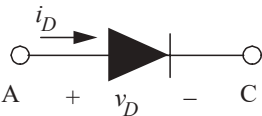
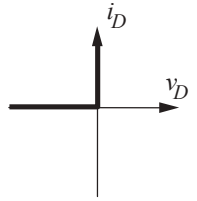
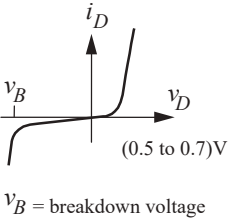
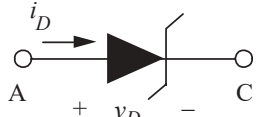
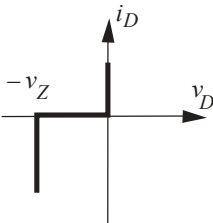
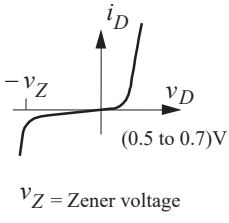
DIODES			
Device and Schematic Symbol	Ideal $I-V$ Relationship	Realistic $I-V$ Relationship	Mathematical $I-V$ Relationship
<p>(Junction Diode)</p> 		 <p>$v_B = \text{breakdown voltage}$</p>	<p>Shockley Equation</p> $i_D \approx I_s \left[e^{(v_D/\eta V_T)} - 1 \right]$ <p>where I_s = saturation current η = emission coefficient, typically 1 for Si V_T = thermal voltage = $\frac{kT}{q}$</p>
<p>(Zener Diode)</p> 		 <p>$v_Z = \text{Zener voltage}$</p>	<p>Same as above.</p>

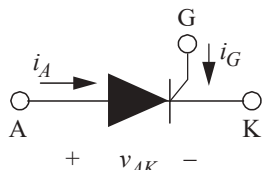
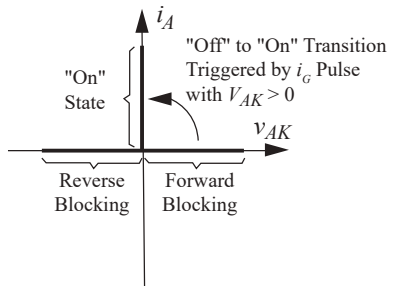
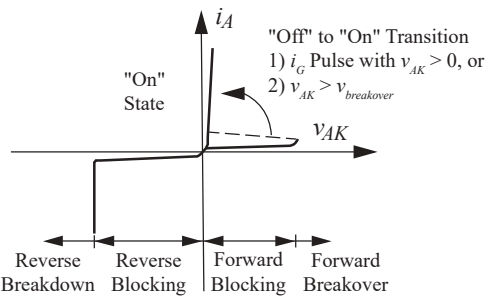
Thyristor or Silicon Controlled Rectifier (SCR)		
Schematic Symbol	Ideal $I-V$ Relationship	Realistic $I-V$ Relationship
	 <p>"Off" to "On" Transition Triggered by i_G Pulse with $v_{AK} > 0$</p> <p>"On" State</p> <p>Reverse Blocking Forward Blocking</p>	 <p>"Off" to "On" Transition</p> <ol style="list-style-type: none"> i_G Pulse with $v_{AK} > 0$, or $v_{AK} > v_{breakover}$ <p>"On" State</p> <p>Reverse Breakdown Reverse Blocking Forward Blocking Forward Breakover</p>

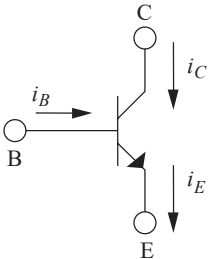
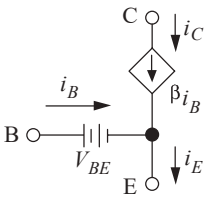
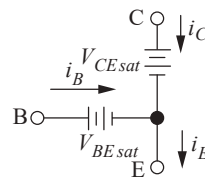
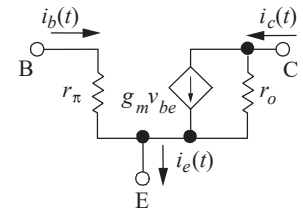
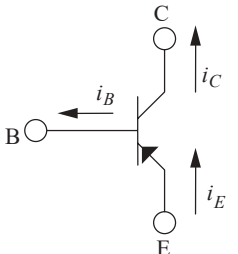
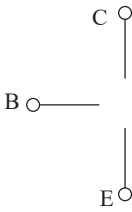
Bipolar Junction Transistor (BJT)			
Schematic Symbol	Mathematical Relationships	Large-Signal (DC) Equivalent Circuit	Low-Frequency Small-Signal (AC) Equivalent Circuit
 <p>NPN – Transistor</p>	$i_E = i_B + i_C$ $i_C = \beta i_B$ $i_C = \alpha i_E$ $\alpha = \beta / (\beta + 1)$ $i_C \approx I_S e^{(V_{BE}/V_T)}$ $I_S = \text{emitter saturation current}$ $V_T = \text{thermal voltage}$ <p>Note: These relationships are valid in the active mode of operation.</p>	<p><u>Active Region:</u> base emitter junction forward biased; base collector junction reverse biased</p> 	<p><u>Low Frequency:</u></p> $g_m \approx I_{CQ}/V_T$ $r_\pi \approx \beta/g_m$ $r_o = \left[\frac{\partial v_{CE}}{\partial i_c} \right]_{Q_{point}} \approx \frac{V_A}{I_{CQ}}$ <p>where I_{CQ} = dc collector current at the Q_{point} V_A = Early voltage</p>
		<p><u>Saturation Region:</u> both junctions forward biased</p> 	
 <p>PNP – Transistor</p>	<p>Same as for NPN with current directions and voltage polarities reversed.</p>	<p><u>Cutoff Region:</u> both junctions reverse biased</p> 	<p>Same as for NPN.</p>
		<p>Same as NPN with current directions and voltage polarities reversed</p>	

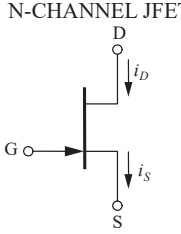
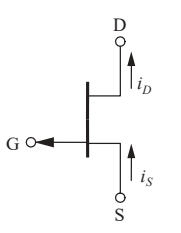
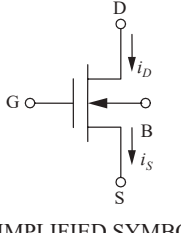
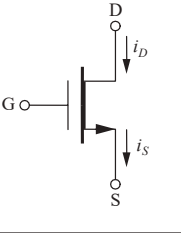
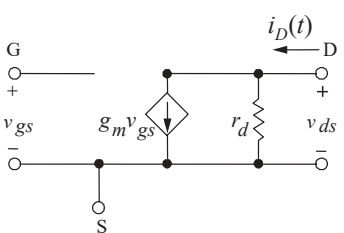
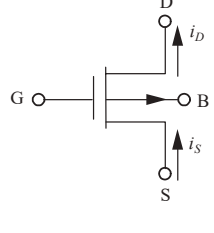
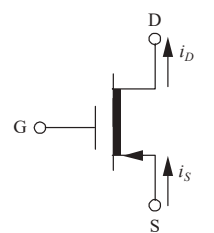
Junction Field Effect Transistors (JFETs) and Depletion MOSFETs (Low and Medium Frequency)		
Schematic Symbol	Mathematical Relationships	Small-Signal (AC) Equivalent Circuit
<p>N-CHANNEL JFET</p>  <p>P-CHANNEL JFET</p>  <p>N-CHANNEL DEPLETION MOSFET (NMOS)</p>  <p>SIMPLIFIED SYMBOL</p> 	<p><u>Cutoff Region:</u> $v_{GS} < V_p$ $i_D = 0$</p> <p><u>Triode Region:</u> $v_{GS} > V_p$ and $v_{GD} > V_p$ $i_D = (I_{DSS}/V_p^2)[2v_{DS}(v_{GS} - V_p) - v_{DS}^2]$</p> <p><u>Saturation Region:</u> $v_{GS} > V_p$ and $v_{GD} < V_p$ $i_D = I_{DSS}(1 - v_{GS}/V_p)^2$</p> <p>where I_{DSS} = drain current with $v_{GS} = 0$ (in the saturation region) $= KV_p^2$, K = conductivity factor</p> <p>For JFETs, V_p = pinch-off voltage</p> <p>For MOSFETs, $V_p = V_T$ = threshold voltage</p>	<p>$g_m = \frac{2\sqrt{I_{DSS}I_D}}{ V_p }$ in saturation region</p>  <p>where $r_d = \left. \frac{\partial v_{ds}}{\partial i_d} \right _{Q_{point}}$</p>
<p>P-CHANNEL DEPLETION MOSFET (PMOS)</p>  <p>SIMPLIFIED SYMBOL</p> 	<p>Same as for N-Channel with current directions and voltage polarities reversed</p>	<p>Same as for N-Channel</p>

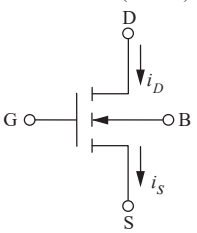
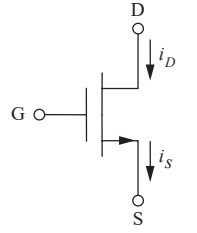
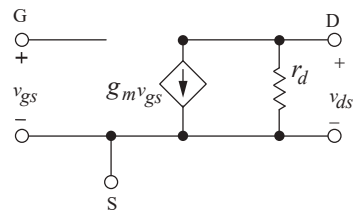
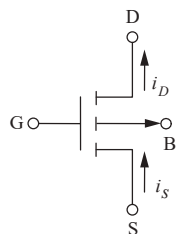
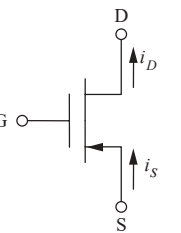
Enhancement MOSFET (Low and Medium Frequency)		
Schematic Symbol	Mathematical Relationships	Small-Signal (AC) Equivalent Circuit
<p>N-CHANNEL ENHANCEMENT MOSFET (NMOS)</p>  <p>SIMPLIFIED SYMBOL</p> 	<p><u>Cutoff Region:</u> $v_{GS} < V_t$ $i_D = 0$</p> <p><u>Triode Region:</u> $v_{GS} > V_t$ and $v_{GD} > V_t$ $i_D = K [2v_{DS} (v_{GS} - V_t) - v_{DS}^2]$</p> <p><u>Saturation Region:</u> $v_{GS} > V_t$ and $v_{GD} < V_t$ $i_D = K (v_{GS} - V_t)^2$ where $K =$ conductivity factor $V_t =$ threshold voltage</p>	<p>$g_m = 2K(v_{GS} - V_t)$ in saturation region</p>  <p>where</p> $r_d = \left. \frac{\partial v_{ds}}{\partial i_d} \right _{Q_{point}}$
<p>P-CHANNEL ENHANCEMENT MOSFET (PMOS)</p>  <p>SIMPLIFIED SYMBOL</p> 	<p>Same as for N-channel with current directions and voltage polarities reversed</p>	<p>Same as for N-channel</p>

Number Systems and Codes

An unsigned number of base- r has a decimal equivalent D defined by

$$D = \sum_{k=0}^n a_k r^k + \sum_{i=1}^m a_i r^{-i}$$

where

a_k = the $(k + 1)$ digit to the left of the radix point

a_i = the i th digit to the right of the radix point

Binary Number System

In digital computers, the base-2, or binary, number system is normally used. Thus the decimal equivalent, D , of a binary number is given by

$$D = a_k 2^k + a_{k-1} 2^{k-1} + \dots + a_0 + a_{-1} 2^{-1} + \dots$$

Since this number system is so widely used in the design of digital systems, we use a short-hand notation for some powers of two:

$2^{10} = 1,024$ is abbreviated "K" or "kilo"

$2^{20} = 1,048,576$ is abbreviated "M" or "mega"

Signed numbers of base- r are often represented by the radix complement operation. If M is an N -digit value of base- r , the radix complement $R(M)$ is defined by

$$R(M) = r^N - M$$

The 2's complement of an N -bit binary integer can be written

$$2\text{'s Complement } (M) = 2^N - M$$

This operation is equivalent to taking the 1's complement (inverting each bit of M) and adding one.

The following table contains equivalent codes for a four-bit binary value.

Binary Base-2	Decimal Base-10	Hexa-decimal Base-16	Octal Base-8	Packed BCD Code	Gray Code
0000	0	0	0	0000	0000
0001	1	1	1	0001	0001
0010	2	2	2	0010	0011
0011	3	3	3	0011	0010
0100	4	4	4	0100	0110
0101	5	5	5	0101	0111
0110	6	6	6	0110	0101
0111	7	7	7	0111	0100
1000	8	8	10	1000	1100
1001	9	9	11	1001	1101
1010	10	A	12	---	1111
1011	11	B	13	---	1110
1100	12	C	14	---	1010
1101	13	D	15	---	1011
1110	14	E	16	---	1001
1111	15	F	17	---	1000

Logic Operations and Boolean Algebra

Three basic logic operations are the "AND (\bullet)," "OR (+)," and "Exclusive-OR (\oplus)" functions. The definition of each function, its logic symbol, and its Boolean expression are given in the following table.

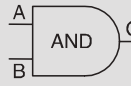
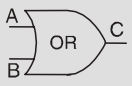
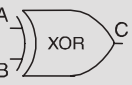
Function			
Inputs	A B	A B	A B
	$C = A \bullet B$	$C = A + B$	$C = A \oplus B$
0 0	0	0	0
0 1	0	1	1
1 0	0	1	1
1 1	1	1	0

As commonly used, A AND B is often written AB or $A \bullet B$.

The not operator inverts the sense of a binary value ($0 \rightarrow 1, 1 \rightarrow 0$)

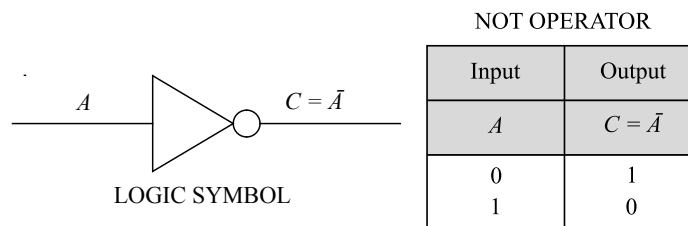

De Morgan's Theorems

First theorem: $\overline{A + B} = \bar{A} \bullet \bar{B}$

Second theorem: $\overline{A \bullet B} = \bar{A} + \bar{B}$

These theorems define the NAND gate and the NOR gate.

Logic symbols for these gates are shown below.

NAND Gates: $\overline{A \bullet B} = \bar{A} + \bar{B}$

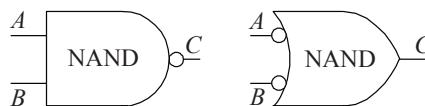

NOR Gates: $\overline{A + B} = \bar{A} \bullet \bar{B}$

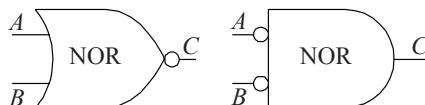

Flip-Flops

A flip-flop is a device whose output can be placed in one of two states, 0 or 1. The flip-flop output is synchronized with a clock (CLK) signal. Q_n represents the value of the flip-flop output before CLK is applied, and Q_{n+1} represents the output after CLK has been applied. Three basic flip-flops are described below.

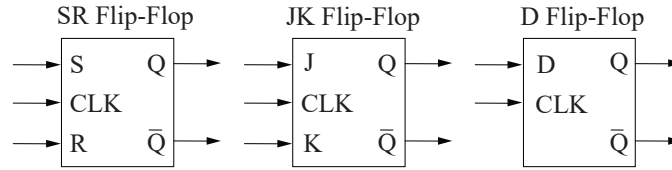

SR	Q_{n+1}	JK	Q_{n+1}	D	Q_{n+1}
00	Q_n no change	00	Q_n no change	0	0
01	0	01	0	1	1
10	1	10	1		
11	x invalid	11	\bar{Q}_n toggle		

Composite Flip-Flop State Transition						
Q_n	Q_{n+1}	S	R	J	K	D
0	0	0	x	0	x	0
0	1	1	0	1	x	1
1	0	0	1	x	1	0
1	1	x	0	x	0	1

Switching Function Terminology

Minterm, m_i – A product term which contains an occurrence of every variable in the function.

Maxterm, M_i – A sum term which contains an occurrence of every variable in the function.

Implicant – A Boolean algebra term, either in sum or product form, which contains one or more minterms or maxterms of a function.

Prime Implicant – An implicant which is not entirely contained in any other implicant.

Essential Prime Implicant – A prime implicant which contains a minterm or maxterm which is not contained in any other prime implicant.

A function can be described as a sum of minterms using the notation

$$F(ABCD) = \Sigma m(h, i, j, \dots)$$

$$= m_h + m_i + m_j + \dots$$

A function can be described as a product of maxterms using the notation

$$G(ABCD) = \Pi M(h, i, j, \dots)$$

$$= M_h \cdot M_i \cdot M_j \cdot \dots$$

A function represented as a sum of minterms only is said to be in *canonical sum of products* (SOP) form. A function represented as a product of maxterms only is said to be in *canonical product of sums* (POS) form. A function in canonical SOP form is often represented as a *minterm list*, while a function in canonical POS form is often represented as a *maxterm list*.

A *Karnaugh Map* (K-Map) is a graphical technique used to represent a truth table. Each square in the K-Map represents one minterm, and the squares of the K-Map are arranged so that the adjacent squares differ by a change in exactly one variable. A four-variable K-Map with its corresponding minterms is shown below. K-Maps are used to simplify switching functions by visually identifying all essential prime implicants.

	CD	00	01	11	10
AB					
00		m ₀	m ₁	m ₃	m ₂
01		m ₄	m ₅	m ₇	m ₆
11		m ₁₂	m ₁₃	m ₁₅	m ₁₄
10		m ₈	m ₉	m ₁₁	m ₁₀

Computer Networking

Modern computer networks are primarily packet switching networks. This means that the messages in the system are broken down, or segmented into packets, and the packets are transmitted separately into the network. The primary purpose of the network is to exchange messages between endpoints of the network called hosts or nodes, typically computers, servers, or handheld devices. At the host, the packets are reassembled into the message and delivered to a software application, e.g., a browser, email, or video player.

Two widely used abstract models for modern computer networks are the open systems interconnect (OSI) model and the TCP/IP model shown in the figure below.

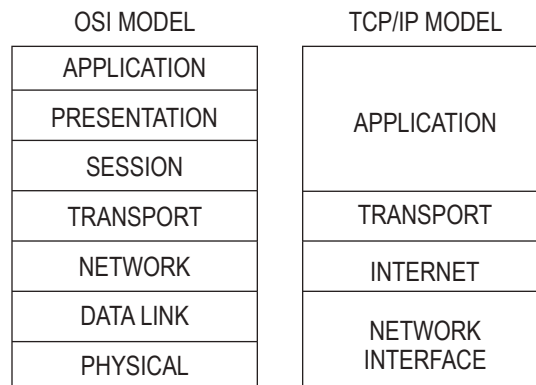

Tanenbaum, Andrew S., *Computer Networks*, 3rd ed., Prentice Hall, 1996, p. 36.

The application layer on the TCP/IP model corresponds to the three upper layers (application, presentation, and session) of the OSI model. The network interface layer of the TCP/IP model corresponds to the bottom two layers (data link and physical) of the OSI model.

The application layer is the network layer closest to the end user, which means both the application layer and the user interact directly with the software application. This layer interacts with software applications that implement a communicating component.

In the OSI model, the application layer interacts with the presentation layer. The presentation layer is responsible for the delivery and formatting of information to the application layer for further processing or display. It relieves the application layer of concern regarding syntactical differences in data representation within the end-user systems.

The OSI session layer provides the mechanism for opening, closing, and managing a session between end-user application processes. It provides for full-duplex, half-duplex, or simplex operation, and establishes checkpointing, adjournment, termination, and restart procedures.

The transport layer adds a transport header normally containing TCP and UDP protocol information. The transport layer provides logical process-to-process communication primitives. Optionally, it may provide other services, such as reliability, in-order delivery, flow control, and congestion control.

The network layer or Internet layer adds another header normally containing the IP protocol; the main role of the networking layer is finding appropriate routes between end hosts, and forwarding the packets along these routes.

The link layer or data link layer contains protocols for transmissions between devices on the same link and usually handles error detection and correction and medium-access control.

The physical layer specifies physical transmission parameters (e.g., modulation, coding, channels, data rates) and governs the transmission of frames from one network element to another sharing a common link.

Hosts, routers, and link-layer switches showing the four-layer protocol stack with different sets of layers for hosts, a switch, and a router are shown in the figure below.

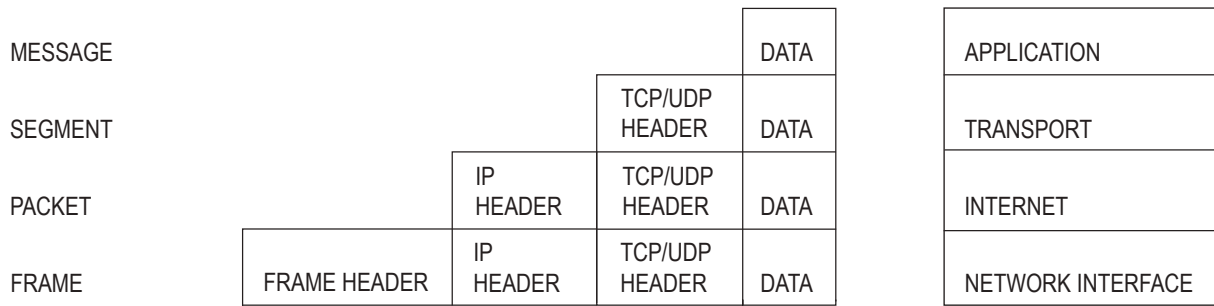

ENCAPSULATION OF APPLICATION DATA THROUGH EACH LAYER

In computer networking, encapsulation is a method of designing modular communication protocols in which logically separate functions in the network are abstracted from their underlying structures by inclusion or information hiding within higher-level objects. For example, a network layer packet is encapsulated in a data link layer frame.

Abbreviation

- ACK Acknowledge
- ARQ Automatic request
- BW Bandwidth
- CRC Cyclic redundancy code
- DHCP Dynamic host configuration protocol
- IP Internet protocol
- LAN Local area network
- NAK Negative acknowledgement
- OSI Open systems interconnect
- TCP Transmission control protocol

Protocol Definitions

- TCP/IP is the basic communication protocol suite for communication over the Internet.
- Internet Protocol (IP) provides end-to-end addressing and is used to encapsulate TCP or UDP datagrams. Both version 4 (IPv4) and version 6 (IPv6) are used and can co-exist on the same network.
- Transmission Control Protocol (TCP) is a connection-oriented protocol that detects lost packets, duplicated packets, or packets that are received out of order and has mechanisms to correct these problems.
- User Datagram Protocol (UDP), is a connectionless-oriented protocol that has less network overhead than TCP but provides no guarantee of delivery, ordering, or duplicate protection.
- Internet Control Message Protocol (ICMP) is a supporting protocol used to send error messages and operational information.

Internet Protocol Addressing

This section from Hinden, R., and S. Deering, eds., *RFC 1884--IP Version 6 Addressing Architecture*, 1995, as found on <https://tools.ietf.org/html/rfc1884> on October 16, 2019; and Information Science Institute, University of Southern California, *RFC 791--Internet Protocol*, 1981, as found on <https://tools.ietf.org/html/rfc791> on October 16, 2019

IPv4 addresses are 32 bits in length and represented in dotted-decimal format using 4 decimal numbers separated by dots, e.g., 192.268.1.1. IPv6 addresses are 128 bits and are represented by eight groups of 4 hexadecimal digits separated by colons. Each group of digits is separated by a colon, e.g., 2001:0db8:85a3:0000:0000:8a2e:0370:7334. Optionally, leading zeros in a group may be dropped in order to shorten the representation, e.g., 2001:db8:85a3:0:0:8a2e:370:7334. One or more consecutive groups containing zeros only may be replaced with a single empty group, using two consecutive colons (::), e.g., 2001:db8:85a3::8a2e:370:7334. For both IPv4 and IPv6, the network address ranges can be specified in slash (/) - CIDR (Classless Inter-Domain Routing) notation after the address. The integer following the slash indicates the number of leftmost bits that are common to all addresses on the network. Alternately, for IPv4 the address range may also be specified by a network mask, a 32 bit dotted decimal number with ones for all bits common to the address space, e.g., 192.168.5.0/24 can be represented by 192.168.5.0/255.255.255.0.

IPv4 Special Address Blocks				
Address block	Address range	Number of addresses	Scope	Description
0.0.0.0/8	0.0.0.0– 0.255.255.255	16777216	Software	Current network (only valid as source address).
10.0.0.0/8	10.0.0.0– 10.255.255.255	16777216	Private network	Used for local communications within a private network.
100.64.0.0/10	100.64.0.0– 100.127.255.255	4194304	Private network	Shared address space for communications between a service provider and its subscribers when using a carrier-grade NAT.
127.0.0.0/8	127.0.0.0– 127.255.255.255	16777216	Host	Used for loopback addresses to the local host.
169.254.0.0/16	169.254.0.0– 169.254.255.255	65536	Subnet	Used for link-local addresses between two hosts on a single link when no IP address is otherwise specified, such as would have normally been retrieved from a DHCP server.
172.16.0.0/12	172.16.0.0– 172.31.255.255	1048576	Private network	Used for local communications within a private network.
192.0.0.0/24	192.0.0.0– 192.0.0.255	256	Private network	IETF Protocol Assignments.
192.0.2.0/24	192.0.2.0– 192.0.2.255	256	Documentation	Assigned as TEST-NET-1, documentation and examples.
192.88.99.0/24	192.88.99.0– 192.88.99.255	256	Internet	Reserved. Formerly used for IPv6 to IPv4 relay (included IPv6 address block 2002::/16).
192.168.0.0/16	192.168.0.0– 192.168.255.255	65536	Private network	Used for local communications within a private network.
198.18.0.0/15	198.18.0.0– 198.19.255.255	131072	Private network	Used for benchmark testing of inter-network communications between two separate subnets.
198.51.100.0/24	198.51.100.0– 198.51.100.255	256	Documentation	Assigned as TEST-NET-2, documentation and examples.
203.0.113.0/24	203.0.113.0– 203.0.113.255	256	Documentation	Assigned as TEST-NET-3, documentation and examples.
224.0.0.0/4	224.0.0.0– 239.255.255.255	268435456	Internet	In use for IP multicast. (Former Class D network.)
240.0.0.0/4	240.0.0.0– 255.255.255.254	268435456	Internet	Reserved for future use. (Former Class E network.)
255.255.255.255/32	255.255.255.255	1	Subnet	Reserved for the "limited broadcast" destination address.

IPv6 Special Address Blocks					
Address block (CIDR)	First address	Last address	Number of addresses	Usage	Purpose
::/0	::	fff:fff:fff:fff:fff:fff:fff:fff	2^{128}	Routing	Default route.
::/128	::		1	Software	Unspecified address.
::1/128	::1		1	Host	Loopback address to the local host.
::ffff:0:0/96	::ffff:0:0:0.0	::ffff:255.255.255.255	$2^{128-96} = 2^{32} = 4294967296$	Software	IPv4 mapped addresses.
::ffff:0:0:0/96	::ffff:0:0:0.0:0	::ffff:0:255.255.255.255	2^{32}	Software	IPv4 translated addresses.
64:ff9b::/96	64:ff9b::0:0:0.0	64:ff9b::255.255.255.255	2^{32}	Global Internet	IPv4/IPv6 translation.
100::/64	100::	100::fff:fff:fff:fff	2^{64}	Routing	Discard prefix.
2001::/32	2001::	2001::fff:fff:fff:fff:fff:fff	2^{96}	Global Internet	Teredo tunneling.
2001:20::/28	2001:20::	2001:2f:fff:fff:fff:fff:fff:fff	2^{100}	Software	ORCHIDv2.
2001:db8::/32	2001:db8::	2001:db8:fff:fff:fff:fff:fff:fff	2^{96}	Documentation	Addresses used in documentation and example source code.
fc00::/7	fc00::	fdf:fff:fff:fff:fff:fff:fff:fff	2^{121}	Private network	Unique local address.
fe80::/10	fe80::	febf:fff:fff:fff:fff:fff:fff:fff	2^{118}	Link	Link-local address.
ff00::/8	ff00::	fff:fff:fff:fff:fff:fff:fff:fff	2^{120}	Global Internet	Multicast address.

Internet Protocol version 4 Header

The IPv4 packet header consists of 14 fields, of which 13 are required. The 14th field is optional and named: options. The fields in the header are packed with the most significant byte first (big endian), and for the diagram and discussion, the most significant bits are considered to come first (MSB 0 bit numbering). The most significant bit is numbered 0, so the version field is actually found in the four most significant bits of the first byte, for example.

IPv4 Header Format																																	
Offsets	Octet	0								1								2								3							
Octet	Bit	0	1	2	3	4	5	6	7	8	9	10	11	12	13	14	15	16	17	18	19	20	21	22	23	24	25	26	27	28	29	30	31
0	0	Version				IHL				DSCP				ECN				Total Length															
4	32	Identification																Flags		Fragment Offset													
8	64	Time To Live								Protocol								Header Checksum															
12	96	Source IP Address																															
16	128	Destination IP Address																															
20	160	Options (if IHL > 5)																															
24	192																																
28	224																																
32	256																																

Version

The first header field in an IP packet is the four-bit version field. For IPv4, this is always equal to 4.

Internet Header Length (IHL)

The Internet Header Length (IHL) field has 4 bits, which is the number of 32-bit words. Since an IPv4 header may contain a variable number of options, this field specifies the size of the header (this also coincides with the offset to the data). The minimum value for this field is 5 which indicates a length of $5 \times 32 \text{ bits} = 160 \text{ bits} = 20 \text{ bytes}$. As a 4-bit field, the maximum value is 15 words ($15 \times 32 \text{ bits}$, or $480 \text{ bits} = 60 \text{ bytes}$).

Differentiated Services Code Point (DSCP)

Originally defined as the type of service (ToS), this field specifies differentiated services (DiffServ). New technologies are emerging that require real-time data streaming and therefore make use of the DSCP field. An example is Voice over IP (VoIP), which is used for interactive voice services.

Explicit Congestion Notification (ECN)

This field allows end-to-end notification of network congestion without dropping packets. ECN is an optional feature that is only used when both endpoints support it and are willing to use it. It is effective only when supported by the underlying network.

Total Length

This 16-bit field defines the entire packet size in bytes, including header and data. The minimum size is 20 bytes (header without data) and the maximum is 65,535 bytes. All hosts are required to be able to reassemble datagrams of size up to 576 bytes, but most modern hosts handle much larger packets. Sometimes links impose further restrictions on the packet size, in which case datagrams must be fragmented. Fragmentation in IPv4 is handled in either the host or in routers.

Identification

This field is an identification field and is primarily used for uniquely identifying the group of fragments of a single IP datagram.

Flags

A three-bit field follows and is used to control or identify fragments. They are (in order, from most significant to least significant):

- bit 0: Reserved; must be zero
- bit 1: Don't Fragment (DF)
- bit 2: More Fragments (MF)

If the DF flag is set, and fragmentation is required to route the packet, then the packet is dropped. This can be used when sending packets to a host that does not have resources to handle fragmentation. It can also be used for path MTU discovery, either automatically by the host IP software, or manually using diagnostic tools such as ping or traceroute. For unfragmented packets, the MF flag is cleared. For fragmented packets, all fragments except the last have the MF flag set. The last fragment has a non-zero Fragment Offset field, differentiating it from an unfragmented packet.

Fragment Offset

The fragment offset field is measured in units of eight-byte blocks. It is 13 bits long and specifies the offset of a particular fragment relative to the beginning of the original unfragmented IP datagram. The first fragment has an offset of zero. This allows a maximum offset of $(2^{13} - 1) \times 8 = 65,528$ bytes, which would exceed the maximum IP packet length of 65,535 bytes with the header length included ($65,528 + 20 = 65,548$ bytes).

Time To Live (TTL)

An eight-bit time to live field helps prevent datagrams from persisting (e.g., going in circles) on an internet. This field limits a datagram's lifetime. It is specified in seconds, but time intervals less than 1 second are rounded up to 1. In practice, the field has become a hop count—when the datagram arrives at a router, the router decrements the TTL field by one. When the TTL field hits zero, the router discards the packet and typically sends an ICMP Time Exceeded message to the sender. The program traceroute uses these ICMP Time Exceeded messages to print the routers used by packets to go from the source to the destination.

Protocol

This field defines the protocol used in the data portion of the IP datagram.

Header Checksum

The 16-bit IPv4 header checksum field is used for error-checking of the header. When a packet arrives at a router, the router calculates the checksum of the header and compares it to the checksum field. If the values do not match, the router discards the packet. Errors in the data field must be handled by the encapsulated protocol. Both UDP and TCP have checksum fields. When a packet arrives at a router, the router decreases the TTL field. Consequently, the router must calculate a new checksum.

Source Address

This field is the IPv4 address of the sender of the packet. Note that this address may be changed in transit by a network address translation device.

Destination Address

This field is the IPv4 address of the receiver of the packet. As with the source address, this may be changed in transit by a network address translation device.

Options

The options field is not often used. Note that the value in the IHL field must include enough extra 32-bit words to hold all the options (plus any padding needed to ensure that the header contains an integer number of 32-bit words). The list of options may be terminated with an EOL (End of Options List, 0x00) option; this is only necessary if the end of the options would not otherwise coincide with the end of the header. The possible options that can be put in the header are as follows:

Field	Size (bits)	Description
Copied	1	Set to 1 if the options need to be copied into all fragments of a fragmented packet.
Option Class	2	A general options category. 0 is for "control" options, and 2 is for "debugging and measurement." 1 and 3 are reserved.
Option Number	5	Specifies an option.
Option Length	8	Indicates the size of the entire option (including this field). This field may not exist for simple options.
Option Data	Variable	Option-specific data. This field may not exist for simple options.

Internet Protocol version 6 Header

The fixed header starts an IPv6 packet and has a size of 40 octets (320 bits). It has the following format:

Offsets	Octet	0						1						2						3													
Octet	Bit	0	1	2	3	4	5	6	7	8	9	10	11	12	13	14	15	16	17	18	19	20	21	22	23	24	25	26	27	28	29	30	31
0	0	Version				Traffic Class				Flow Label																							
4	32	Payload Length												Next Header								Hop Limit											
8	64	Source Address																															
12	96																																
16	128																																
20	160																																
24	192	Destination Address																															
28	224																																
32	256																																
36	288																																

Version (4 bits)

The constant 6 (bit sequence 0110).

Traffic Class (6+2 bits)

The bits of this field hold two values. The six most-significant bits hold the Differentiated Services (DS) field, which is used to classify packets. Currently, all standard DS fields end with a '0' bit. Any DS field that ends with two '1' bits is intended for local or experimental use.[4]

The remaining two bits are used for Explicit Congestion Notification (ECN); priority values subdivide into ranges: traffic where the source provides congestion control and non-congestion control traffic.

Flow Label (20 bits)

Originally created for giving real-time applications special service. When set to a non-zero value, it serves as a hint to routers and switches with multiple outbound paths that these packets should stay on the same path, so that they will not be reordered. It has further been suggested that the flow label be used to help detect spoofed packets.

Payload Length (16 bits)

The size of the payload in octets, including any extension headers. The length is set to zero when a Hop-by-Hop extension header carries a Jumbo Payload option.

Next Header (8 bits)

Specifies the type of the next header. This field usually specifies the transport layer protocol used by a packet's payload. When extension headers are present in the packet, this field indicates which extension header follows. The values are shared with those used for the IPv4 protocol field, as both fields have the same function.

Hop Limit (8 bits)

Replaces the time to live field of IPv4. This value is decremented by one at each forwarding node and packet discarded if it becomes 0. However destination node should process the packet normally even if hop limit becomes 0.

Source Address (128 bits)

The IPv6 address of the sending node.

Reserved (3 bits)

For future use and should be set to zero.

Flags (9 bits) (aka Control bits)

Contains 9 1-bit flags

- NS (1 bit): ECN-nonce - concealment protection (experimental).
- CWR (1 bit): Congestion Window Reduced (CWR) flag is set by the sending host to indicate that it received a TCP segment with the ECE flag set and had responded in congestion control mechanism.
- ECE (1 bit): ECN-Echo has a dual role, depending on the value of the SYN flag. It indicates:
 - If the SYN flag is set (1), that the TCP peer is ECN capable.
 - If the SYN flag is clear (0), that a packet with Congestion Experienced flag set (ECN=11) in the IP header was received during normal transmission. This serves as an indication of network congestion (or impending congestion) to the TCP sender.
- URG (1 bit): indicates that the Urgent pointer field is significant
- ACK (1 bit): indicates that the Acknowledgment field is significant. All packets after the initial SYN packet sent by the client should have this flag set.
- PSH (1 bit): Push function. Asks to push the buffered data to the receiving application.
- RST (1 bit): Reset the connection
- SYN (1 bit): Synchronize sequence numbers. Only the first packet sent from each end should have this flag set. Some other flags and fields change meaning based on this flag, and some are only valid when it is set, and others when it is clear.
- FIN (1 bit): Last packet from sender.

Window Size (16 bits)

The size of the receive window, which specifies the number of window size units (by default, bytes) (beyond the segment identified by the sequence number in the acknowledgment field) that the sender of this segment is currently willing to receive.

Checksum (16 bits)

The 16-bit checksum field is used for error-checking of the header, the Payload and a Pseudo-Header. The Pseudo-Header consists of the Source IP Address, the Destination IP Address, the protocol number for the TCP-Protocol (0x0006) and the length of the TCP-Headers including Payload (in Bytes).

Urgent Pointer (16 bits)

If the URG flag is set, then this 16-bit field is an offset from the sequence number indicating the last urgent data byte.

Options (Variable 0–320 bits, divisible by 32)

The length of this field is determined by the data offset field. Options have up to three fields: Option-Kind (1 byte), Option-Length (1 byte), Option-Data (variable). The Option-Kind field indicates the type of option, and is the only field that is not optional. Depending on what kind of option we are dealing with, the next two fields may be set: the Option-Length field indicates the total length of the option, and the Option-Data field contains the value of the option, if applicable. For example, an Option-Kind byte of 0x01 indicates that this is a No-Op option used only for padding, and does not have an Option-Length or Option-Data byte following it. An Option-Kind byte of 0 is the End Of Options option, and is also only one byte. An Option-Kind byte of 0x02 indicates that this is the Maximum Segment Size option, and will be followed by a byte specifying the length of the MSS field (should be 0x04). This length is the total length of the given options field, including Option-Kind and Option-Length bytes. So while the MSS value is typically expressed in two bytes, the length of the field will be 4 bytes (+2 bytes of kind and length). In short, an MSS option field with a value of 0x05B4 will show up as (0x02 0x04 0x05B4) in the TCP options section.

Some options may only be sent when SYN is set; they are indicated below as. Option-Kind and standard lengths given as (Option-Kind, Option-Length).

- 0 (8 bits): End of options list
- 1 (8 bits): No operation (NOP, Padding) This may be used to align option fields on 32-bit boundaries for better performance.
- 2,4,SS (32 bits): Maximum segment size
- 3,3,S (24 bits): Window scale
- 4,2 (16 bits): Selective Acknowledgement permitted.
- 5,N,BBBB,EEEE,... (variable bits, N is either 10, 18, 26, or 34)- Selective ACKnowledgement (SACK) These first two bytes are followed by a list of 1–4 blocks being selectively acknowledged, specified as 32-bit begin/end pointers.
- 8,10,TTTT,EEEE (80 bits)- Timestamp and echo of previous timestamp
- The remaining options are historical, obsolete, experimental, not yet standardized, or unassigned. Option number assignments are maintained by the IANA.

Padding

The TCP header padding is used to ensure that the TCP header ends, and data begins, on a 32 bit boundary. The padding is composed of zeros.

User Datagram Protocol

UDP Header																																	
Offsets	Octet	0								1								2								3							
Octet	Bit	0	1	2	3	4	5	6	7	8	9	10	11	12	13	14	15	16	17	18	19	20	21	22	23	24	25	26	27	28	29	30	31
0	0	Source port																Destination port															
4	32	Length																Checksum															

The UDP header consists of four fields, each of which is 2 bytes (16 bits). The use of the checksum and source port fields is optional in IPv4 (gray background in table). In IPv6 only the source port field is optional.

Source Port Number

This field identifies the sender's port, when used. If not used, it should be zero.

Destination Port Number

This field identifies the receiver's port and is required.

Length

This field that specifies the length in bytes of the UDP header and UDP data. The minimum length is 8 bytes, the length of the header. The field size sets a theoretical limit of 65,535 bytes (8 byte header + 65,527 bytes of data) for a UDP datagram. However, the actual limit for the data length, which is imposed by the underlying IPv4 protocol, is 65,507 bytes (65,535 – 8 byte UDP header – 20 byte IP header).

Using IPv6 jumbograms, it is possible to have UDP packets of size greater than 65,535 bytes. RFC 2675 specifies that the length field is set to zero if the length of the UDP header plus UDP data is greater than 65,535.

Checksum

The checksum field may be used for error-checking of the header and data. This field is optional in IPv4 and mandatory in IPv6. The field carries all-zeros if unused.

Internet Control Message Protocol

The Internet Control Message Protocol (ICMP) is a supporting protocol in the Internet protocol suite and is used for Internet Protocol version 4 (IPv4). It is used by network devices, including routers, to send error messages and operational information indicating, for example, that a requested service is not available or that a host or router could not be reached. Internet Control Message Protocol version 6 (ICMPv6) is the implementation of ICMP for Internet Protocol version 6 (IPv6).

ICMP and ICMPv6 Header Format																																	
Offsets	Octet	0								1								2								3							
Octet	Bit	0	1	2	3	4	5	6	7	8	9	10	11	12	13	14	15	16	17	18	19	20	21	22	23	24	25	26	27	28	29	30	31
0	0	Type								Code								Checksum															
4	32	Rest of Header																															

Partial List of ICMP Type and Code Values (IPv4)

ICMP Type	ICMP Code
0 = Echo Reply	0
3 = Destination Unreachable	0 = net unreachable
	1 = host unreachable
	2 = protocol unreachable
	4 = fragmentation needed and DF set
	5 = source route failed
5 = Redirect Message	0 = Redirect Datagram for the Network
	1 = Redirect Datagram for the Host
	2 = Redirect Datagram for the ToS and network
	3 = Redirect Datagram for the ToS and host
8 = Echo Request	0
9 = Router Advertisement	0
10 = Router Solicitation	0
11 = Time Exceeded	0 = TTL expired in transit
	1 = Fragment reassembly time exceeded

Partial List of ICMPv6 Type and Code Values

ICMPv6 Type	ICMPv6 Code
1 = Destination Unreachable	0 = no router to destination
	1 = communication with destination administratively prohibited
	2 = Beyond scope of source address
	3 = address unreachable
	4 = port unreachable
	5 = source address failed ingress/egress policy
	6 = reject route to destination
	7 = Error in Source Routing Header
2 = Packet Too Big	0
3 = Time exceeded	0 = hop limit exceeded in transit
	1 = fragment reassembly time exceeded
4 = Parameter problem	0 = erroneous header field encountered
	1 = unrecognized Next Header type encountered
	2 = unrecognized IPv6 option encountered
128 = Echo Request	0
129 = Echo Reply	0
130 = Multicast Listener Query	0
131 = Multicast listener Done	0
133 = Router Solicitation	0
134 = Router Advertisement	0
135 = Neighbor Solicitation	0
136 = Neighbor Advertisement	0
137 = Redirect Message	0
138 = Router Renumbering	0 = Router Renumbering Command
	1 = Router Renumbering Result
	255 = Sequence Number Reset
139 = ICMP Node Information Query	0 = The Data field contains an IPv6 address which is the Subject of this Query
	1 = The Data field contains a name which is the Subject of this Query, or is empty, as in the case of a NOOP.
	2 = The Data field contains an IPv4 address which is the Subject of this Query
140 = ICMP Node Information Response	0 = A successful reply. The Reply Data field may or may not be empty.
	1 = The Responder refuses to supply the answer. The Reply Data field will be empty.
	2 = The Qtype of the Query is unknown to the Responder. The Reply Data field will be empty.
141 = Inverse Neighbor Discovery Solicitation Message	0
142 = Inverse Neighbor Discovery Advertisement Message	0
143 = Multicast Listener Discovery (MLDv2) reports	0
144 = Home Agent Address Discovery Request Message	0
145 = Home Agent Address Discovery Reply Message	0
146 = Mobile Prefix Solicitation	0
147 = Mobile Prefix Advertisement	0
148 = Certification Path Solicitation	0
149 = Certification Path Advertisement	0
151 = Multicast Router Advertisement	0
152 = Multicast Router Solicitation	0
153 = Multicast Router Termination	0
155 = RPL Control Message	0

Local Area Network (LAN)

There are different methods for assigning IP addresses for devices entering a network.

- Dynamic host configuration protocol (DHCP) is a networking protocol that allows a router to assign the IP address and other configuration information for all stations joining a network.
- Static IP addressing implies each station joining a network is manually configured with its own IP address.
- Stateless address autoconfiguration (SLAAC) allows for hosts to automatically configure themselves when connecting to an IPv6 network.

Network Topologies

Point-to-Point



Token Ring

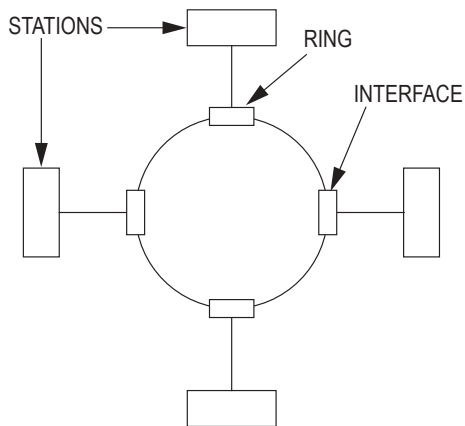

Bus

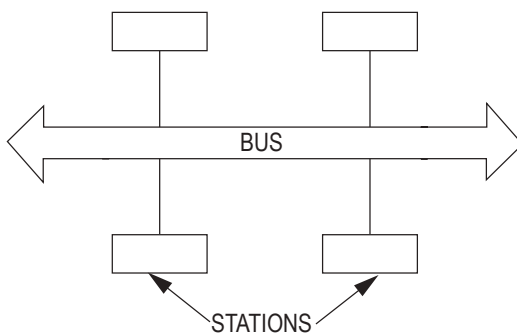

Star

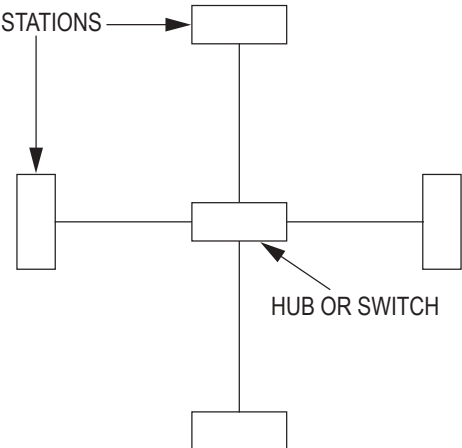

Mesh

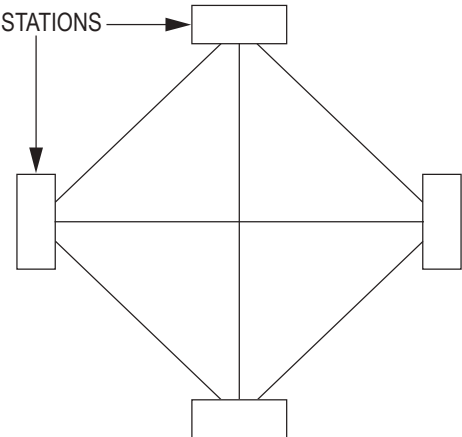

Tree

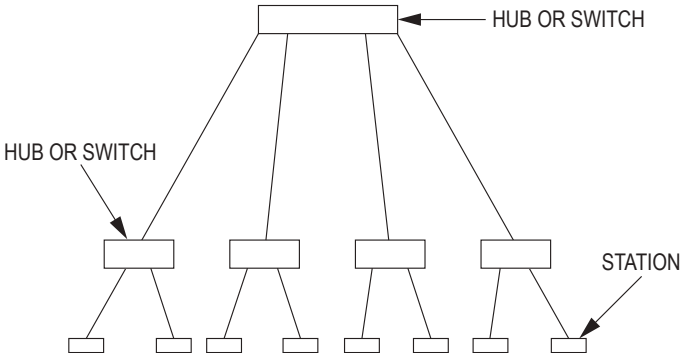

Communication Methodologies

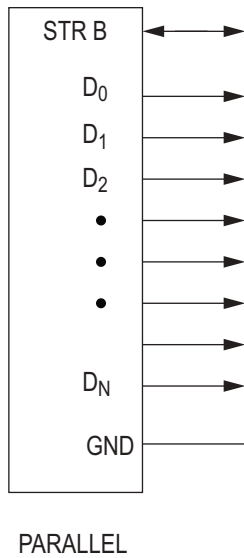
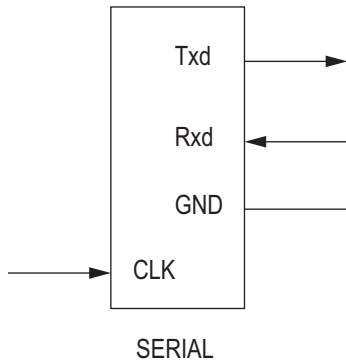

Serial

A communications channel where data is sent sequentially one bit at a time. RS-232 and RS-485 are common interfaces of this type.

Parallel

A communications channel where data is sent several bits as a whole. IEEE 1284 is a common interface.

Simplex

A single channel where communications is one direction only.

Half-Duplex

Provides communications in two directions but only one at a time

Full Duplex (Duplex)

Allows communications in both directions simultaneously

Computer Systems

Memory/Storage Types

RAM – Primary memory system in computing systems, volatile

Cache – faster, but smaller segment of memory used for buffering immediate data from slower memories

- L1: Level 1 cache, fastest memory available
- L2: Level 2 cache, next level away from CPU. May or may not be exclusive of L1 depending on architecture

ROM – nonvolatile. Contains system instructions or constant data for the system

Replacement Policy – For set associative and fully associative caches, if there is a miss and the set or cache (respectively) is full, then a block must be selected for replacement. The replacement policy determines which block is replaced. Common replacement policies are:

- Least recently used (LRU): Replace the least recently used block.
- Most recently used (MRU): Replace the most recently used block.
- First-in, first-out (FIFO): Also referred to as first come, first serve (FCFS) queue. Data is processed in the order it entered the buffer.
- Last-in, first-out (LIFO): Also referred to as a stack. Youngest (last) item is processed first.
- Random: Choose a block at random for replacement.
- Least frequently used (LFU): Replace the block that had the fewest references among the candidate blocks.

Write Policy – With caches, multiple copies of a memory block may exist in the system (e.g., a copy in the cache and a copy in main memory). There are two possible write policies.

- Write-through: Write to both the cache's copy and the main memory's copy.
- Write-back: Write only to the cache's copy. This requires adding a "dirty bit" for each block in the cache. When a block in the cache is written to, its dirty bit is set to indicate that the main memory's copy is stale. When a dirty block is evicted from the cache (due to a replacement), the entire block must be written back to main memory. Clean blocks need not be written back when they are evicted.

Cache Size – $C \text{ (bytes)} = S * A * B$

where

S = Number of sets

A = Set associativity

B = Block size (bytes)

To search for the requested block in the cache, the CPU will generally divide the address into three fields: the tag, index, and block offset.



- *Tag* – These are the most significant bits of the address, which are checked against the current row (the row that has been retrieved by index) to see if it is the one needed or another, irrelevant memory location that happened to have the same index bits as the one wanted.

tag bits = # address bits – # index bits – # block offset bits

- *Index* – These bits specify which cache row (set) that the data has been put in.

index bits = $\log_2(\# \text{ sets}) = \log_2(S)$

- *Block Offset* – These are the lower bits of the address that select a byte within the block.

block offset bits = $\log_2(\text{block size}) = \log_2(B)$

Microprocessor Architecture – Harvard

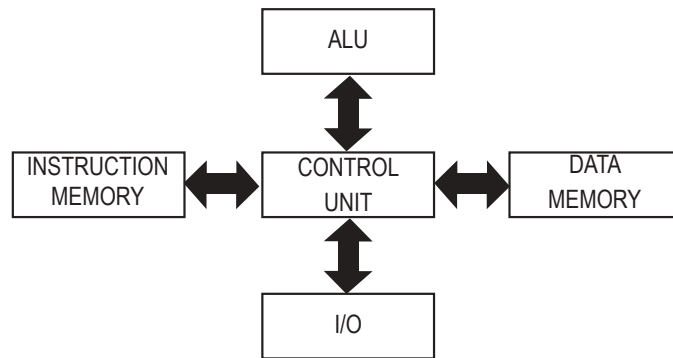

Multicore

A multicore processor is a single computing component with two or more independent actual processing units (called cores), which are the units that read and execute program instructions. The instructions are ordinary CPU instructions such as Add, Move Data, and Branch, but the multiple cores can run multiple instructions at the same time, increasing overall speed for programs amenable to parallel computing.

A multicore processor implements multiprocessing in a single physical package. Designers may couple cores in a multicore device tightly or loosely. For example, cores may or may not share caches, and they may implement message passing or shared memory intercore communication methods. Common network topologies to interconnect cores include bus, ring, two-dimensional mesh, and crossbar. Homogeneous multicore systems include only identical cores; heterogeneous multicore systems have cores that are not identical. Just as with single-processor systems, cores in multicore systems may implement architectures such as superscalar, VLIW, vector processing, SIMD, or multithreading.

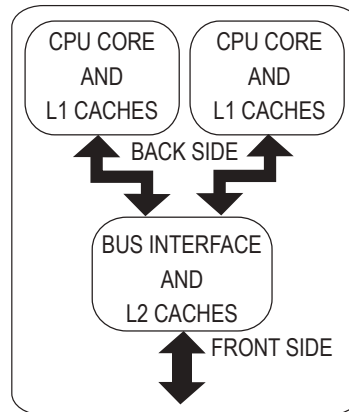

Generic dual-core processor, with CPU-local level 1 caches, and a shared, on-die level 2 cache

Threading

In computer science, a thread of execution is the smallest sequence of programmed instructions that can be managed independently by a scheduler, which is typically a part of the operating system. The implementation of threads and processes differs between operating systems, but in most cases a thread is a component of a process. Multiple threads can exist within the same process and share resources such as memory, while different processes do not share these resources. In particular, the threads of a process share its instructions (executable code) and its context (the values of its variables at any given moment).

On a single processor, multithreading is generally implemented by time-division multiplexing (as in multitasking), and the CPU switches between different software threads. This context switching generally happens frequently enough that the user perceives the threads or tasks as running at the same time. On a multiprocessor or multicore system, threads can be executed in a true concurrent manner, with every processor or core executing a separate thread simultaneously. To implement multiprocessing, the operating system may use hardware threads that exist as a hardware-supported method for better utilization of a particular CPU. These are different from the software threads that are a pure software construct with no CPU-level representation.

Abbreviation

CISC	Complex instruction set computing
CPU	Central processing unit
FIFO	First-in, first-out
LIFO	Last-in, first-out
I/O	Input/output
LFU	Least frequently used
LRU	Least recently used
MRU	Most recently used
RISC	Reduced instruction set computing
RAM	Random access memory
ROM	Read only memory

Software Engineering

Endianness

MSB – most significant bit first. Also known as Big-endian.

LSB – least significant bit first. Also known as Little-endian.

Pointers

A pointer is a reference to an object. The literal value of a pointer is the object's location in memory. Extracting the object referenced by a pointer is defined as dereferencing.

Algorithms

An algorithm is a specific sequence of steps that describe a process.

Sorting Algorithm – an algorithm that transforms a random collection of elements into a sorted collection of elements.

Examples include:

Bubble Sort: continuously steps through a list, swapping items until they appear in the correct order.

Insertion Sort: takes elements from a list one by one and inserts them in their correct position into a new sorted list.

Merge Sort: divides the list into the smallest unit (e.g., 1 element), then compares each element with the adjacent list to sort and merge the two adjacent lists. This process continues with larger lists until at last, two lists are merged into the final sorted list.

Heap Sort: divides a list into sorted and an unsorted lists and extracts the largest element from the unsorted list and moves it to the bottom of the sorted list.

Quick Sort: partitions list using a pivot value, placing elements smaller than the pivot before the pivot value and greater elements after it. The lesser and greater sublists are then recursively sorted.

Searching Algorithm – an algorithm that determines if an element exists in a collection of elements. If the element does exist, its location is also returned. Examples include:

Binary search: finds a search value within a sorted list by comparing the search value to the middle element of the array. If they are not equal, the half in which the target cannot lie is eliminated and the search continues on the remaining half, again taking the middle element to compare to the target value, and repeating this until the target value is found.

Hashing: uses a hashing function that maps data of arbitrary size (e.g., a string of characters) to data of a fixed size (e.g., an integer) and then to compute an index that suggests where the entry can be found in a hash table (an array of buckets or slots, from which the desired value can be found through the index).

Data Structures

Collection – a grouping of elements that are stored and accessed using algorithms. Examples include:

Array: collection of elements, typically of the same type, where each individual element can be accessed using an integer index.

Linked list: collection of nodes, where each node contains an element and a pointer to the next node in the linked list (and sometimes back to the previous node).

Stack: collection of elements that are kept in order and can only be accessed at one end of the set (e.g., last in, first out (LIFO))

Queue: collection of elements that are kept in order and can be accessed at both ends of the set where one is used to insert elements and the other end is used to remove elements.

Map: collection of key, value pairs, such that each possible key appears at most once in the collection. Also known as an associative array.

Set: collection of elements, without any particular order, that can be queried (static sets) and/or modified by inserting or deleting elements (dynamic set).

Graph: collection of nodes and a set of edges which connect a pair of nodes.

Tree: a collection of nodes and a set of edges that connect the nodes hierarchically. One node is distinguished as a root and every other node is connected by a directed edge from exactly one other node in a parent to child relationship. A binary tree is a specialized case where each parent node can have no more than two children nodes.

Graph Traversal

There are primarily two algorithms used to parse through each node in a graph.

Breadth First Search – Beginning at a given node, the algorithm visits all connected nodes that have not been visited. The algorithm repeats for each visited node. The output of the algorithm is a list of nodes in the order that they have been visited. A queue data structure can be used to facilitate this algorithm.

Depth First Search – Beginning at a given node, the algorithm visits one connected node that has not been visited. This is repeated until a node does not have any connected nodes that have not been visited. At this point the algorithm backtracks to the last visited node and repeats the algorithm. The output of the algorithm is a list of nodes in the order that they have been visited. A stack can be used to facilitate this algorithm.

Tree Traversal

There are three primary algorithms that are used to traverse a binary tree data structure.

In-Order Traversal

1. Traverse the left sub-tree.
2. Visit the root node.
3. Traverse the right sub-tree.

Preorder Traversal

1. Visit the root node.
2. Traverse the left sub-tree.
3. Traverse the right sub-tree.

Postorder Traversal

1. Traverse the left sub-tree.
2. Traverse the right sub-tree.
3. Visit the root node.

Algorithm Efficiency (Big-O)

The concept of Big O Notation is used in software engineering to determine the efficiency of an algorithm. Big O equations are written as:

$$O(n) = f(n)$$

When comparing the efficiency of two algorithms, compare two $O(n)$ values as n approaches infinity.

Notation	Name	Example (Worst Case)
$O(\log n)$	Logarithmic	Binary tree traversal, Hash table search
$O(n \log(n)) = O(\log n!)$	Loglinear	Merge sort, Heap sort, Fast Fourier Transform
$O(n^2)$	Quadratic	Insertion sort, Bubble sort, Quick sort

Software Syntax Guidelines

- Code is pseudocode, no specific language
- No end-of-line punctuation (e.g., semicolon) is used
- Comments are indicated with "--" double hyphen
- Loop structures end with "end" followed by structure name, e.g., "end while"
- "do-while" begins with "do" and ends with "while"—no "end" per se
- "if-then" statements have both "if" and "then"
- "else if" is a substitute for the "end" on the preceding "if"
- "=" is used to designate assignment. "==" refers to comparison in a conditional statement.
- Not equals is represented by \diamond
- Logical "and" and "or" are spelled out as "and" and "or"
- Variable and argument declarations are Pascal style—"name: type"
- Numeric data types are "integer" and "float"
- Text is a procedural variable, unless specified to be an object of type String
- Variables can be constant, and are declared with the "const" modifier
- Variables whose type is object and the exact specification of that object is not critical to the problem must have the data type obj
- Array indices are designated with square brackets [], not parentheses
- Unless otherwise specified, arrays begin at 1 (one)
- Compilation units are "procedure" and "function". "Module" is not a compilation unit
- Function parameters are designated with parentheses ()
- Unless specified, procedures and functions must have the return type "void"
- Arguments in a function/procedure call are separated by semicolons
- Class definitions start with "cls" (e.g., clsClassName)
- Classes, properties, and procedures are by default public and may be optionally modified by "private" or "protected"
- To instantiate an object, the follow syntax must be used: new clsName objName
- For input, read ("filename.ext", <variable list>)—if reading from console, do not use the first argument
- For output, write ("filename.ext", <expression list>)—if writing to console, do not use the first argument
- The Boolean data type is "boolean"; the return result of all comparison operators is a boolean type

- The operator "*" in front of a variable is used to return the data at the address location within that variable
- The operator "&" in front of a variable is used to return the address of a given variable. The declaration of "pointer_to" is used to define a variable of a pointer type

Flow Chart Definition

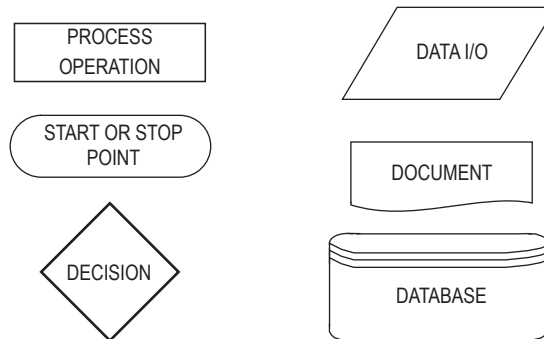

Software Testing

There are many approaches to software testing but they are typically split into static testing versus dynamic and black box versus white box testing.

Static Testing: techniques that do not execute the code but concentrate on checking the code, requirement documents and design documents. Examples: code reviews and walkthroughs and compiler syntax and structure checks.

Dynamic Testing: techniques that take place when the code is executed and is performed in the runtime environment. Examples: unit, integration, system, and acceptance testing.

Black Box Testing: examines functionality without knowledge of the internal code. Also known as functional testing, the approach oftentimes concentrates on checking performance against specifications and also avoids programmer bias.

White Box Testing: verifies the internal structures and workings of a code. The approach is a necessary part of software testing at the unit, integration and system levels, needed to uncover errors or problems, but does not detect unimplemented parts of the specification or missing requirements.

Computer Network Security

Source for material in Computer Network Security: Barrett, Diane, Martin M. Weiss, and Kirk Hausman, *CompTIA Security+™ SYO-401 Exam Cram*, 4th ed., Pearson IT Certification, Pearson Education, Inc., 2015.

Firewalls

A network security system that monitors and controls incoming and outgoing network traffic based on predetermined security rules. A firewall typically establishes a barrier between a trusted internal network and untrusted external network, such as the Internet.

Nmap

Usage: nmap [Scan Type(s)] [Options] {target specification}

Target Specification

Can pass hostnames, IP addresses, networks, etc.

Ex: scanme.nmap.org, microsoft.com/24, 192.168.0.1; 10.0.0-255.1-254

Host Discovery

sL: List Scan - simply list targets to scan

sn: Ping Scan - disable port scan

PS/PA/PU/PY[portlist]: TCP SYN/ACK, UDP or SCTP discovery to given ports

PE/PP/PM: ICMP echo, timestamp, and netmask request discovery probes

PO[protocol list]: IP Protocol Ping

dns-servers: Specify custom DNS servers

system-dns: Use OS's DNS resolver

traceroute: Trace hop path to each host

Scan Techniques

sS/sT/sA/sW/sM: TCP SYN/Connect()/ACK/Window/Maimon scans

sU: UDP Scan

sN/sF/sX: TCP Null, FIN, and Xmas scans

scanflags: Customize TCP scan flags

sO: IP protocol scan

b: FTP bounce scan

Port Specification and Scan Order

p: Only scan specified ports

Ex: -p22; -p1-65535; -p U:53,111,137,T:21-25,80,139,8080,S:9

Service/Version Detection

sV: Probe open ports to determine service/version info

OS Detection

O: Enable OS detection

Timing and Performance

Options which take <time> are in seconds, or append 'ms' (milliseconds),

's' (seconds), 'm' (minutes), or 'h' (hours) to the value (e.g., 30m).

max-retries: Caps number of port scan probe retransmissions.

host-timeout: Give up on target after this long

scan-delay/--max-scan-delay: Adjust delay between probes

min-rate: Send packets no slower than per second

max-rate: Send packets no faster than per second

Firewall/IDS Evasion and Spoofing

S: Spoof source address

e: Use specified interface

g/--source-port: Use given port number

data-length: Append random data to sent packets

Output

-oN/-oX/-oS/-oG: Output scan in normal, XML, s|: Output in the three major formats at once

open: Only show open (or possibly open) ports

packet-trace: Show all packets sent and received

Misc.

6: Enable IPv6 scanning

A: Enable OS detection, version detection, script scanning, and traceroute

V: Print version number

h: Print this help summary page.

Examples

```
nmap -v -A scanme.nmap.org
```

```
nmap -v -sn 192.168.0.0/16 10.0.0.0/8
```

```
nmap -v -iR 10000 -Pn -p 80
```

Port Scanning

Generally either TCP or UDP ports are scanned. Types of TCP scans include SYN, TCP Connect, NULL, FIN, XMAS

Common TCP Ports

<u>Protocol</u>	<u>Port Number</u>
FTP	20, 21
Telnet	23
HTTP	80
HTTPS	443
POP3	110
SMTP	25
TLS	587

Web Vulnerability Testing

OWASP – Open Web Application Security Project. Online community that provides many open source resources for web application security

Cross Site Scripting(XSS) – script injection attack, using a web application to send an attack to another user

Cross Site Request Forgery(CRSF) – an attack that forces user to perform unwanted actions with current authorizations. Usually coupled with a social engineering attack.

SQL Injection(SQLi) – injection attack, by inserting SQL query via input data from the client to the application for execution. The statements usually insert, select, delete or update stored data in the SQL database.

Endpoint Detection – collection and storage of endpoint data activity to help network administrators analyze, investigate and prevent cyber threats on a network.

WEP – Wired Equivalent Privacy – Uses 40 bit(10 hex digits) or 104(26 hex digits) bit key

WPA– Wifi Protected Access – Replacement for WPA, added TKIP and MIC

WPA2 – Replaced WPA and implements all mandatory elements of 802.11i, particularly mandatory support for CCMP(AES encryption mode)

WPA3 – Replaces WPA2. Replaces PSK with Simultaneous Exchange of Equals

Penetration Testing – Authorized Vulnerability Testing

Phases

1. Reconnaissance
2. Scanning
3. Gaining Access
4. Maintaining Access
5. Covering Tracks

Methods

External testing—Only systems and assets that are visible on the internet, such as the web application itself, are targeted. The goal of the testing is to gain access to the application and its data.

Internal testing—The pen tester has access to the application behind the firewall.

Blind testing—The pen tester is given the name of the company, but nothing else. This simulates an actual application

attack in real-time.

Double-blind testing—This is similar to a blind test, but the security team is not made aware of the simulation.

Targeted testing—The penetration tester and security team work together, informing each other of steps taken to attack the application and to defend against the attack. (Red Team vs Blue Team)

Security Triad

AIC—Availability, Integrity, Confidentiality (also referred to as CIA Triad)

Availability—guarantee of reliable access to information by authorized entities

Integrity—assurance information is trustworthy and accurate

Confidentiality—set of rules that limits access to information

Authentication

Three factors for authentication

Something you know (password, PIN, etc)

Something you have (token, smart card, etc)

Something you are (biometrics, etc)

AAA protocols (Authentication, Authorization, Accounting)

TACACS, XTACACS, TACACS+—Terminal Access Controller Access Control System

RADIUS—Remote Authentication Dial In User Service

DIAMETER—Enhancement for RADIUS.

PPP protocols

PAP—Password Authentication Protocol

CHAP—Challenge Handshake Authentication Protocol

EAP—Extensible Authentication Protocol

Other protocols

Kerberos—authentication system using a Key Distribution Center

Key Equations

Assume that "*" implies multiplication.

McCabe's Cyclomatic Complexity

$$c = e - n + 2$$

where for a single program graph, n is the number of nodes, e is the number of edges, and c is the cyclomatic complexity.

The RSA Public-Key Cryptosystem

$$n = p * q$$

where p and q are both primes.

$$e * d = 1 \pmod{t}$$

where $t =$ least common multiple $(p - 1, q - 1)$

- The encrypted cyphertext c of a message m is $c = m^e \pmod{n}$
- The decrypted message is $m = c^d \pmod{n}$
- The signature s of a message m is $s = m^d \pmod{n}$

Diffie-Hellman Key-Exchange Protocol

A sender and receiver separately select private keys x and y . Generator value g and prime number p is shared between the two. Their shared secret key k is:

$$k = (g^x)^y \pmod{p} = (g^y)^x \pmod{p}$$

Industrial and Systems Engineering

Linear Programming

The general linear programming (LP) problem is:

$$\text{Maximize } Z = c_1x_1 + c_2x_2 + \dots + c_nx_n$$

Subject to:

$$a_{11}x_1 + a_{12}x_2 + \dots + a_{1n}x_n \leq b_1$$

$$a_{21}x_1 + a_{22}x_2 + \dots + a_{2n}x_n \leq b_2$$

\vdots

$$a_{m1}x_1 + a_{m2}x_2 + \dots + a_{mn}x_n \leq b_m$$

$$x_1, \dots, x_n \geq 0$$

An LP problem is frequently reformulated by inserting non-negative slack and surplus variables. Although these variables usually have zero costs (depending on the application), they can have non-zero cost coefficients in the objective function. A slack variable is used with a "less than" inequality and transforms it into an equality. For example, the inequality $5x_1 + 3x_2 + 2x_3 \leq 5$ could be changed to $5x_1 + 3x_2 + 2x_3 + s_1 = 5$ if s_1 were chosen as a slack variable. The inequality $3x_1 + x_2 - 4x_3 \geq 10$ might be transformed into $3x_1 + x_2 - 4x_3 - s_2 = 10$ by the addition of the surplus variable s_2 . Computer printouts of the results of processing an LP usually include values for all slack and surplus variables, the dual prices, and the reduced costs for each variable.

Dual Linear Program

Associated with the above linear programming problem is another problem called the dual linear programming problem. If we take the previous problem and call it the primal problem, then in matrix form the primal and dual problems are respectively:

<u>Primal</u>	<u>Dual</u>
Maximize $Z = \mathbf{c}\mathbf{x}$	Minimize $W = \mathbf{y}\mathbf{b}$
Subject to: $\mathbf{A}\mathbf{x} \leq \mathbf{b}$	Subject to: $\mathbf{y}\mathbf{A} \geq \mathbf{c}$
$\mathbf{x} \geq 0$	$\mathbf{y} \geq 0$

It is assumed that if \mathbf{A} is a matrix of size $[m \times n]$, then \mathbf{y} is a $[1 \times m]$ vector, \mathbf{c} is a $[1 \times n]$ vector, \mathbf{b} is an $[m \times 1]$ vector, and \mathbf{x} is an $[n \times 1]$ vector.

Network Optimization

Assume we have a graph $G(N, A)$ with a finite set of nodes N and a finite set of arcs A . Furthermore, let

$$N = \{1, 2, \dots, n\}$$

$$x_{ij} = \text{flow from node } i \text{ to node } j$$

$$c_{ij} = \text{cost per unit flow from } i \text{ to } j$$

$$u_{ij} = \text{capacity of arc } (i, j)$$

$$b_i = \text{net flow generated at node } i$$

We wish to minimize the total cost of sending the available supply through the network to satisfy the given demand. The minimal cost flow model is formulated as follows:

$$\text{Minimize } Z = \sum_{i=1}^n \sum_{j=1}^n c_{ij}x_{ij}$$

subject to

$$\sum_{j=1}^n x_{ij} - \sum_{j=1}^n x_{ji} = b_i \text{ for each node } i \in N$$

and

$$0 \leq x_{ij} \leq u_{ij} \text{ for each arc } (i, j) \in A$$

The constraints on the nodes represent a conservation of flow relationship. The first summation represents total flow out of node i , and the second summation represents total flow into node i . The net difference generated at node i is equal to b_i .

Many models, such as shortest-path, maximal-flow, assignment and transportation models, can be reformulated as minimal-cost network flow models.

Process Capability

Actual Capability

$$PCR_k = C_{pk} = \min\left(\frac{\mu - LSL}{3\sigma}, \frac{USL - \mu}{3\sigma}\right)$$

Potential Capability (i.e., Centered Process)

$$PCR = C_p = \frac{USL - LSL}{6\sigma}$$

where

μ and σ are the process mean and standard deviation, respectively, and LSL and USL are the lower and upper specification limits, respectively.

Queueing Models

Definitions

- P_n = probability of n units in system
- L = expected number of units in the system
- L_q = expected number of units in the queue
- W = expected waiting time in system
- W_q = expected waiting time in queue
- λ = mean arrival rate (constant)
- $\tilde{\lambda}$ = effective arrival rate
- μ = mean service rate (constant)
- ρ = server utilization factor
- s = number of servers

Kendall notation for describing a queueing system:

$$A / B / s / M$$

- A = the arrival process
- B = the service time distribution
- s = the number of servers
- M = the total number of customers including those in service

Fundamental Relationships

- $L = \lambda W$
- $L_q = \lambda W_q$
- $W = W_q + 1/\mu$
- $\rho = \lambda/(s\mu)$

Single Server Models ($s = 1$)

Poisson Input—Exponential Service Time: $M = \infty$

$$P_0 = 1 - \lambda/\mu = 1 - \rho$$

$$P_n = (1 - \rho)\rho^n = P_0\rho^n$$

$$L = \rho/(1 - \rho) = \lambda/(\mu - \lambda)$$

$$L_q = \lambda^2/[\mu(\mu - \lambda)]$$

$$W = 1/[\mu(1 - \rho)] = 1/(\mu - \lambda)$$

$$W_q = W - 1/\mu = \lambda/[\mu(\mu - \lambda)]$$

Finite queue: $M < \infty$

$$\tilde{\lambda} = \lambda(1 - P_m)$$

$$P_0 = (1 - \rho)/(1 - \rho^{M+1})$$

$$P_n = [(1 - \rho)/(1 - \rho^{M+1})]\rho^n$$

$$L = \rho/(1 - \rho) - (M + 1)\rho^{M+1}/(1 - \rho^{M+1})$$

$$L_q = L - (1 - P_0)$$

$$W = L/\tilde{\lambda}$$

$$W = W_q + 1/\mu$$

Poisson Input—Arbitrary Service Time

Variance σ^2 is known. For constant service time, $\sigma^2 = 0$.

$$P_0 = 1 - \rho$$

$$L_q = (\lambda^2\sigma^2 + \rho^2)/[2(1 - \rho)]$$

$$L = \rho + L_q$$

$$W_q = L_q/\lambda$$

$$W = W_q + 1/\mu$$

Poisson Input—Erlang Service Times, $\sigma^2 = 1/(k\mu^2)$

$$L_q = [(1 + k)/(2k)][(\lambda^2)/(\mu(\mu - \lambda))]$$

$$= [\lambda^2/(k\mu^2) + \rho^2]/[2(1 - \rho)]$$

$$W_q = [(1 + k)/(2k)]\{\lambda/[\mu(\mu - \lambda)]\}$$

$$W = W_q + 1/\mu$$

Multiple Server Model ($s > 1$)

Poisson Input—Exponential Service Times

Because calculations for P_0 and L_q can be time consuming, the following table gives formulas for 1, 2, and 3 servers.

s	P_0	L_q
1	$1 - \rho$	$\rho^2/(1 - \rho)$
2	$(1 - \rho)/(1 + \rho)$	$2\rho^3/(1 - \rho^2)$
3	$\frac{2(1 - \rho)}{2 + 4\rho + 3\rho^2}$	$\frac{9\rho^4}{2 + 2\rho - \rho^2 - 3\rho^3}$

$$P_n = P_0(\lambda/\mu)^n/n! \quad 0 \leq n \leq s$$

$$P_n = P_0(\lambda/\mu)^n/(s!s^{n-s}) \quad n \geq s$$

$$W_q = L_q/\lambda$$

$$W = W_q + 1/\mu$$

$$L = L_q + \lambda/\mu$$

Simulation

1. Random Variate Generation

The linear congruential method of generating pseudo-random numbers U_i between 0 and 1 is obtained using $Z_n = (aZ_{n-1} + C) \pmod{m}$ where a , C , m , and Z_0 are given nonnegative integers and where $U_i = Z_i/m$. Two integers are equal \pmod{m} if their remainders are the same when divided by m .

2. Inverse Transform Method

If X is a continuous random variable with cumulative distribution function $F(x)$, and U_i is a random number between 0 and 1, then the value of X_i corresponding to U_i can be calculated by solving $U_i = F(x_i)$ for x_i . The solution obtained is $x_i = F^{-1}(U_i)$, where F^{-1} is the inverse function of $F(x)$.

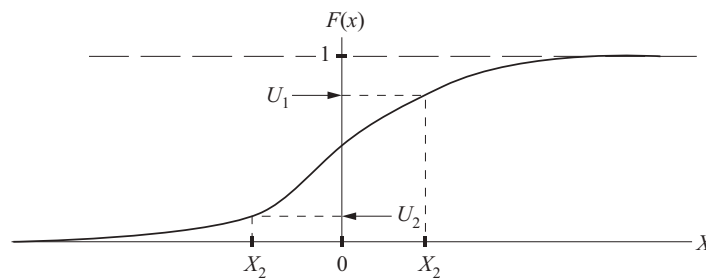

Inverse Transform Method for Continuous Random Variables

Forecasting

Moving Average

$$\hat{d}_t = \frac{\sum_{i=1}^n d_{t-i}}{n}$$

where

\hat{d}_t = forecasted demand for period t

d_{t-i} = actual demand for i th period preceding t

n = number of time periods to include in the moving average

Exponentially Weighted Moving Average

$$\hat{d}_t = \alpha d_{t-1} + (1 - \alpha) \hat{d}_{t-1}$$

where

\hat{d}_t = forecasted demand for t

α = smoothing constant, $0 \leq \alpha \leq 1$

2ⁿ Factorial Experiments

$$E_i = \bar{Y}_{i2} - \bar{Y}_{i1}$$

$$E_{ij} = \frac{(\bar{Y}_{ij}^{22} - \bar{Y}_{ij}^{21}) - (\bar{Y}_{ij}^{12} - \bar{Y}_{ij}^{11})}{2}$$

where

Factors: X_1, X_2, \dots, X_n

Levels of each factor: 1, 2 (sometimes these levels are represented by the symbols – and +, respectively)

r = number of observations for each experimental condition (treatment)

E_i = estimate of the effect of factor X_i , $i = 1, 2, \dots, n$

E_{ij} = estimate of the effect of the interaction between factors X_i and X_j

\bar{Y}_{ik} = average response value for all $r2^{n-1}$ observations having X_i set at level k , $k = 1, 2$

\bar{Y}_{ij}^{km} = average response value for all $r2^{n-2}$ observations having X_i set at level k , $k = 1, 2$, and X_j set at level m , $m = 1, 2$.

Analysis of Variance for 2ⁿ Factorial Designs

Main Effects

Let E be the estimate of the effect of a given factor, let L be the orthogonal contrast belonging to this effect. It can be proved that

$$E = \frac{L}{2^{n-1}}$$

$$L = \sum_{c=1}^m a_{(c)} \bar{Y}^{(c)}$$

$$SS_L = \frac{rL^2}{2^n}$$

where

- m = number of experimental conditions ($m = 2^n$ for n factors)
- $a_{(c)}$ = -1 if the factor is set at its low level (Level 1) in experimental condition c
- $a_{(c)}$ = +1 if the factor is set at its high level (Level 2) in experimental condition c
- r = number of replications for each experimental condition
- $\bar{Y}_{(c)}$ = average response value for experimental condition c
- SS_L = sum of squares associated with the factor

Interaction Effects

Consider any group of two or more factors.

$a_{(c)} = +1$ if there is an even number (or zero) of factors in the group set at the low level (Level 1) in experimental condition $c = 1, 2, \dots, m$

$a_{(c)} = -1$ if there is an odd number of factors in the group set at the low level (Level 1) in experimental condition $c = 1, 2, \dots, m$

It can be proved that the interaction effect E for the factors in the group and the corresponding sum of squares SS_L can be determined as follows:

$$E = \frac{L}{2^{n-1}}$$

$$L = \sum_{c=1}^m a_{(c)} \bar{Y}_{(c)}$$

$$SS_L = \frac{rL^2}{2^n}$$

Sum of Squares of Random Error

The sum of the squares due to the random error can be computed as

$$SS_{\text{error}} = SS_{\text{total}} - \sum_i SS_i - \sum_i \sum_j SS_{ij} - \dots - SS_{12\dots n}$$

where SS_i is the sum of squares due to factor X_i , SS_{ij} is the sum of squares due to the interaction of factors X_i and X_j , and so on. The total sum of squares is equal to

$$SS_{\text{total}} = \sum_{c=1}^m \sum_{k=1}^r Y_{ck}^2 - \frac{T^2}{N}$$

where Y_{ck} is the k th observation taken for the c th experimental condition, $m = 2^n$, T is the grand total of all observations, and $N = r2^n$.

Reliability

If P_i is the probability that component i is functioning, a reliability function $R(P_1, P_2, \dots, P_n)$ represents the probability that a system consisting of n components will work.

For n independent components connected in series,

$$R(P_1, P_2, \dots, P_n) = \prod_{i=1}^n P_i$$

For n independent components connected in parallel,

$$R(P_1, P_2, \dots, P_n) = 1 - \prod_{i=1}^n (1 - P_i)$$

Learning Curves

The time to do the repetition N of a task is given by

$$T_N = KN^s$$

where

K = constant

s = $\ln(\text{learning rate, as a decimal})/\ln 2$; or, learning rate = 2^s

If N units are to be produced, the average time per unit is given by

$$T_{\text{avg}} = \frac{K}{N(1+s)} \left[(N+0.5)^{(1+s)} - 0.5^{(1+s)} \right]$$

Inventory Models

For instantaneous replenishment (with constant demand rate, known holding and ordering costs, and an infinite stockout cost), the economic order quantity is given by

$$EOQ = \sqrt{\frac{2AD}{h}}$$

where

A = cost to place one order

D = number of units used per year

h = holding cost per unit per year

Under the same conditions as above with a finite replenishment rate, the economic manufacturing quantity is given by

$$EMQ = \sqrt{\frac{2AD}{h(1-D/R)}}$$

where R = the replenishment rate

Facility Planning

Equipment Requirements

$$M_j = \sum_{i=1}^n \frac{P_{ij}T_{ij}}{C_{ij}}$$

where

M_j = number of machines of type j required per production period

P_{ij} = desired production rate for product i on machine j , measured in pieces per production period

T_{ij} = production time for product i on machine j , measured in hours per piece

C_{ij} = number of hours in the production period available for the production of product i on machine j

n = number of products

People Requirements

$$A_j = \sum_{i=1}^n \frac{P_{ij}T_{ij}}{C_{ij}}$$

where

A_j = number of crews required for assembly operation j

P_{ij} = desired production rate for product i and assembly operation j (pieces per day)

T_{ij} = standard time to perform operation j on product i (minutes per piece)

C_{ij} = number of minutes available per day for assembly operation j on product i

n = number of products

Standard Time Determination

$$ST = NT \times AF$$

where

NT = normal time

AF = allowance factor

Case 1: Allowances are based on the *job time*.

$$AF_{\text{job}} = 1 + A_{\text{job}}$$

A_{job} = allowance fraction (percentage/100) based on job time.

Case 2: Allowances are based on *workday*.

$$AF_{\text{time}} = 1/(1 - A_{\text{day}})$$

A_{day} = allowance fraction (percentage/100) based on workday.

Predetermined time systems are useful in cases where either (1) the task does not yet exist or (2) changes to a task are being designed and normal times have not yet been established for all elements of the new task or changed task. In such cases no opportunity exists to measure the element time. Unfortunately, there is no scientific basis for predicting element times without breaking them down into motion-level parts. A task consists of elements. An organization may develop its own database of normal element durations, and normal times for new or changed tasks may be predicted if the tasks consist entirely of elements whose normal times are already in the database. But new elements can be decomposed into motions, for which scientifically predetermined times exist in databases called MTM-1, MTM-2, and MTM-3. These databases and software to manipulate them are commercially available. To use one of them effectively requires about 50 hours of training.

Plant Location

The following is one formulation of a discrete plant location problem.

Minimize

$$z = \sum_{i=1}^m \sum_{j=1}^n c_{ij}y_{ij} + \sum_{j=1}^n f_jx_j$$

subject to

$$\sum_{i=1}^m y_{ij} \leq mx_j, \quad j = 1, \dots, n$$

$$\sum_{j=1}^n y_{ij} = 1, \quad i = 1, \dots, m$$

$$y_{ij} \geq 0, \text{ for all } i, j$$

$$x_j = (0, 1), \text{ for all } j$$

Kennedy, W.J., and Daniel P. Rogers, *Review for the Professional Engineers' Examination in Industrial Engineering*, 2012.

where

m = number of customers

n = number of possible plant sites

y_{ij} = fraction or proportion of the demand of customer i which is satisfied by a plant located at site j ;
 $i = 1, \dots, m; j = 1, \dots, n$

x_j = 1, if a plant is located at site j

x_j = 0, otherwise

c_{ij} = cost of supplying the entire demand of customer i from a plant located at site j

f_j = fixed cost resulting from locating a plant at site j

Material Handling

Distances between two points (x_1, y_1) and (x_2, y_2) under different metrics:

Euclidean:

$$D = \sqrt{(x_1 - x_2)^2 + (y_1 - y_2)^2}$$

Rectilinear (or Manhattan):

$$D = |x_1 - x_2| + |y_1 - y_2|$$

Chebyshev (simultaneous x and y movement):

$$D = \max(|x_1 - x_2|, |y_1 - y_2|)$$

Line Balancing

$$N_{\min} = \left(OR \times \sum_i t_i / OT \right)$$

= theoretical minimum number of stations

$$\text{Idle Time/Station} = CT - ST$$

$$\text{Idle Time/Cycle} = \sum (CT - ST)$$

$$\text{Percent Idle Time} = \frac{\text{Idle Time/Cycle}}{N_{\text{actual}} \times CT} \times 100$$

where

CT = cycle time (time between units)

OT = operating time/period

OR = output rate/period

ST = station time (time to complete task at each station)

t_i = individual task times

N = number of stations

Job Sequencing

Two Work Centers—Johnson's Rule

1. Select the job with the shortest time, from the list of jobs, and its time at each work center.
2. If the shortest job time is the time at the first work center, schedule it first, otherwise schedule it last. Break ties arbitrarily.
3. Eliminate that job from consideration.
4. Repeat 1, 2, and 3 until all jobs have been scheduled.

Critical Path Method (CPM)

$$T = \sum_{(i,j) \in CP} d_{ij}$$

where

d_{ij} = duration of activity (i, j)

CP = critical path (longest path)

T = duration of project

PERT

$$\mu_{ij} = \frac{a_{ij} + 4b_{ij} + c_{ij}}{6}$$

$$\sigma_{ij} = \frac{c_{ij} - a_{ij}}{6}$$

$$\mu = \sum_{(i,j) \in CP} \mu_{ij}$$

$$\sigma^2 = \sum_{(i,j) \in CP} \sigma_{ij}^2$$

where

(a_{ij}, b_{ij}, c_{ij}) = (optimistic, most likely, pessimistic) durations for activity (i, j)

μ_{ij} = mean duration of activity (i, j)

σ_{ij} = standard deviation of the duration of activity (i, j)

μ = project mean duration

σ = standard deviation of project duration

Taylor Tool Life Formula

$$VT^n = C$$

where

V = speed in surface feet per minute

T = tool life in minutes

C, n = constants that depend on the material and on the tool

Work Sampling Formulas

$$D = Z_{\alpha/2} \sqrt{\frac{p(1-p)}{n}} \quad \text{and} \quad R = Z_{\alpha/2} \sqrt{\frac{1-p}{pn}}$$

where

p = proportion of observed time in an activity

D = absolute error

R = relative error = D/p

n = sample size

ANTHROPOMETRIC MEASUREMENTS

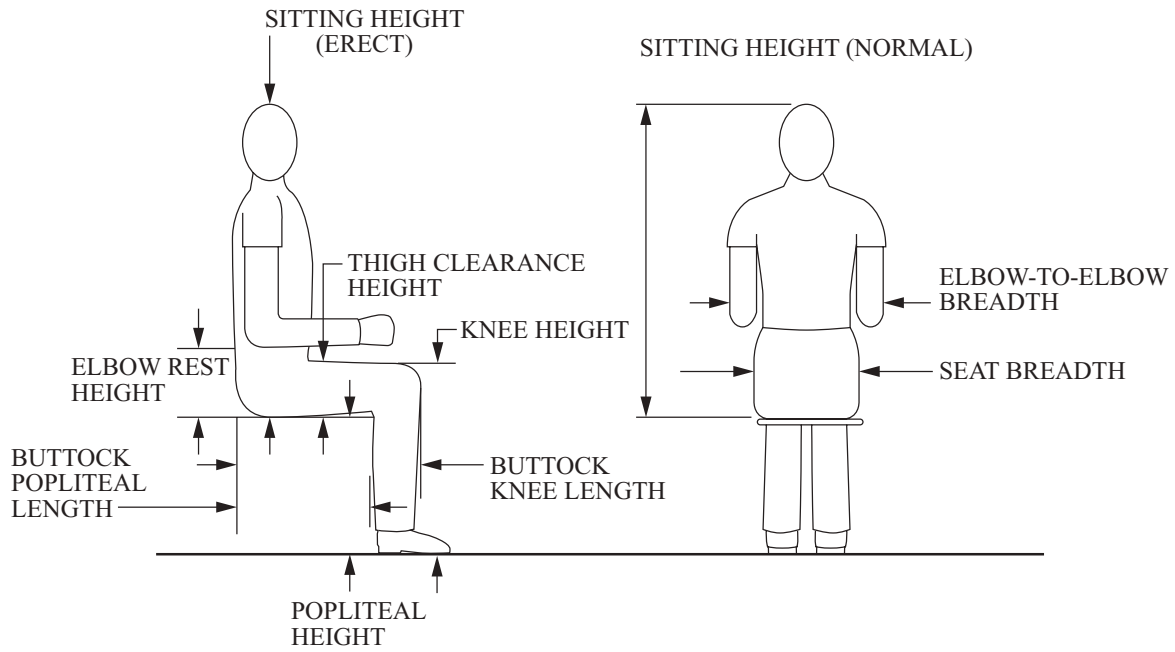

After Sanders and McCormick, *Human Factors In Engineering and Design*, McGraw-Hill, 1987.

U.S. Civilian Body Dimensions, Female/Male, for Ages 20 to 60 Years (Centimeters)				
(See Anthropometric Measurements Figure)	Percentiles			
	5th	50th	95th	Std. Dev.
HEIGHTS				
Stature (height)	149.5 / 161.8	160.5 / 173.6	171.3 / 184.4	6.6 / 6.9
Eye height	138.3 / 151.1	148.9 / 162.4	159.3 / 172.7	6.4 / 6.6
Shoulder (acromion) height	121.1 / 132.3	131.1 / 142.8	141.9 / 152.4	6.1 / 6.1
Elbow height	93.6 / 100.0	101.2 / 109.9	108.8 / 119.0	4.6 / 5.8
Knuckle height	64.3 / 69.8	70.2 / 75.4	75.9 / 80.4	3.5 / 3.2
Height, sitting (erect)	78.6 / 84.2	85.0 / 90.6	90.7 / 96.7	3.5 / 3.7
Eye height, sitting	67.5 / 72.6	73.3 / 78.6	78.5 / 84.4	3.3 / 3.6
Shoulder height, sitting	49.2 / 52.7	55.7 / 59.4	61.7 / 65.8	3.8 / 4.0
Elbow rest height, sitting	18.1 / 19.0	23.3 / 24.3	28.1 / 29.4	2.9 / 3.0
Knee height, sitting	45.2 / 49.3	49.8 / 54.3	54.5 / 59.3	2.7 / 2.9
Popliteal height, sitting	35.5 / 39.2	39.8 / 44.2	44.3 / 48.8	2.6 / 2.8
Thigh clearance height	10.6 / 11.4	13.7 / 14.4	17.5 / 17.7	1.8 / 1.7
DEPTHS				
Chest depth	21.4 / 21.4	24.2 / 24.2	29.7 / 27.6	2.5 / 1.9
Elbow-fingertip distance	38.5 / 44.1	42.1 / 47.9	46.0 / 51.4	2.2 / 2.2
Buttock-knee length, sitting	51.8 / 54.0	56.9 / 59.4	62.5 / 64.2	3.1 / 3.0
Buttock-popliteal length, sitting	43.0 / 44.2	48.1 / 49.5	53.5 / 54.8	3.1 / 3.0
Forward reach, functional	64.0 / 76.3	71.0 / 82.5	79.0 / 88.3	4.5 / 5.0
BREADTHS				
Elbow-to-elbow breadth	31.5 / 35.0	38.4 / 41.7	49.1 / 50.6	5.4 / 4.6
Seat (hip) breadth, sitting	31.2 / 30.8	36.4 / 35.4	43.7 / 40.6	3.7 / 2.8
HEAD DIMENSIONS				
Head breadth	13.6 / 14.4	14.54 / 15.42	15.5 / 16.4	0.57 / 0.59
Head circumference	52.3 / 53.8	54.9 / 56.8	57.7 / 59.3	1.63 / 1.68
Interpupillary distance	5.1 / 5.5	5.83 / 6.20	6.5 / 6.8	0.4 / 0.39
HAND DIMENSIONS				
Hand length	16.4 / 17.6	17.95 / 19.05	19.8 / 20.6	1.04 / 0.93
Breadth, metacarpal	7.0 / 8.2	7.66 / 8.88	8.4 / 9.8	0.41 / 0.47
Circumference, metacarpal	16.9 / 19.9	18.36 / 21.55	19.9 / 23.5	0.89 / 1.09
Thickness, metacarpal III	2.5 / 2.4	2.77 / 2.76	3.1 / 3.1	0.18 / 0.21
Digit 1				
Breadth, interphalangeal	1.7 / 2.1	1.98 / 2.29	2.1 / 2.5	0.12 / 0.13
Crotch-tip length	4.7 / 5.1	5.36 / 5.88	6.1 / 6.6	0.44 / 0.45
Digit 2				
Breadth, distal joint	1.4 / 1.7	1.55 / 1.85	1.7 / 2.0	0.10 / 0.12
Crotch-tip length	6.1 / 6.8	6.88 / 7.52	7.8 / 8.2	0.52 / 0.46
Digit 3				
Breadth, distal joint	1.4 / 1.7	1.53 / 1.85	1.7 / 2.0	0.09 / 0.12
Crotch-tip length	7.0 / 7.8	7.77 / 8.53	8.7 / 9.5	0.51 / 0.51
Digit 4				
Breadth, distal joint	1.3 / 1.6	1.42 / 1.70	1.6 / 1.9	0.09 / 0.11
Crotch-tip length	6.5 / 7.4	7.29 / 7.99	8.2 / 8.9	0.53 / 0.47
Digit 5				
Breadth, distal joint	1.2 / 1.4	1.32 / 1.57	1.5 / 1.8	0.09 / 0.12
Crotch-tip length	4.8 / 5.4	5.44 / 6.08	6.2 / 6.99	0.44 / 0.47
FOOT DIMENSIONS				
Foot length	22.3 / 24.8	24.1 / 26.9	26.2 / 29.0	1.19 / 1.28
Foot breadth	8.1 / 9.0	8.84 / 9.79	9.7 / 10.7	0.50 / 0.53
Lateral malleolus height	5.8 / 6.2	6.78 / 7.03	7.8 / 8.0	0.59 / 0.54
Weight (kg)	46.2 / 56.2	61.1 / 74.0	89.9 / 97.1	13.8 / 12.6

Ergonomics—Hearing

The average shifts with age of the threshold of hearing for pure tones of persons with "normal" hearing, using a 25-year-old group as a reference group.

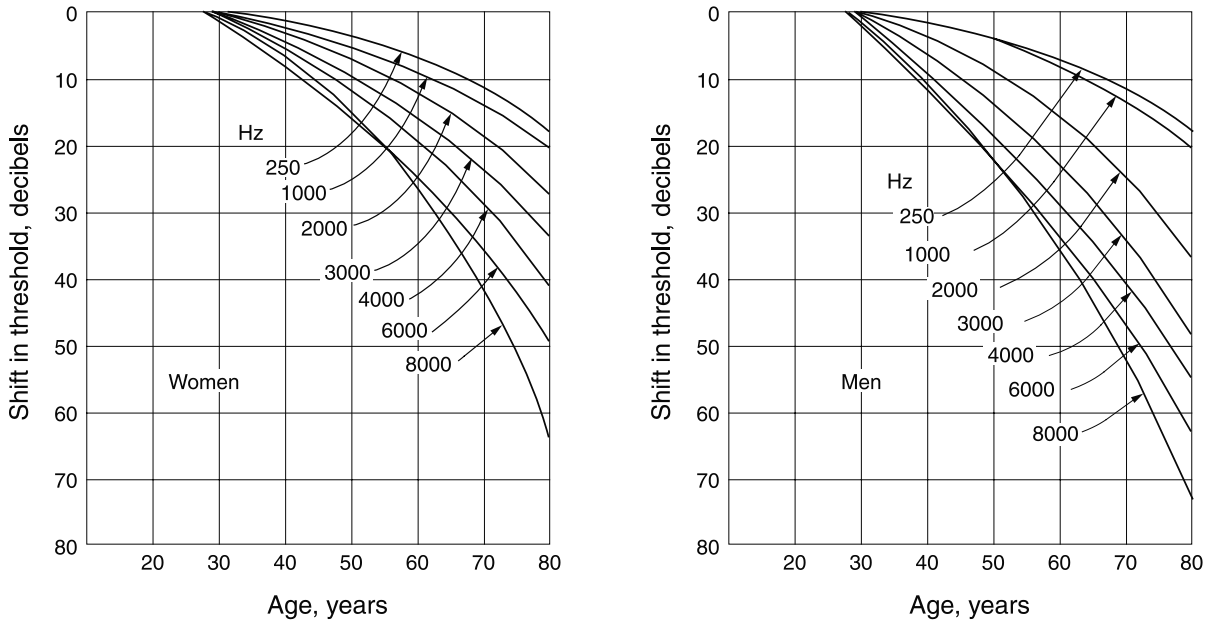

Equivalent sound-level contours used in determining the A-weighted sound level on the basis of an octave-band analysis. The curve at the point of the highest penetration of the noise spectrum reflects the A-weighted sound level.

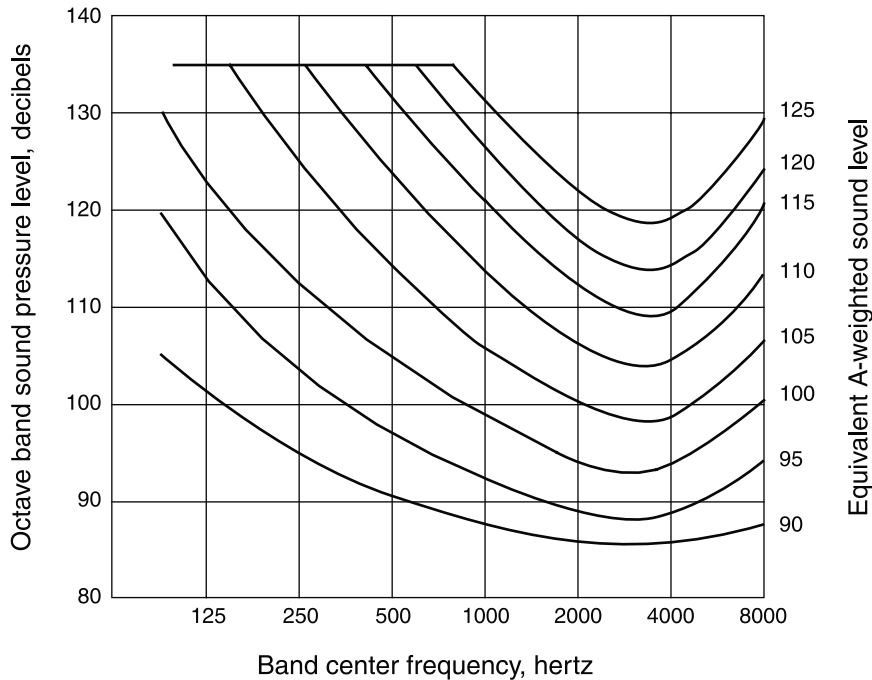

Estimated average trend curves for net hearing loss at 1,000, 2,000, and 4,000 Hz after continuous exposure to steady noise. Data are corrected for age, but not for temporary threshold shift. Dotted portions of curves represent extrapolation from available data.

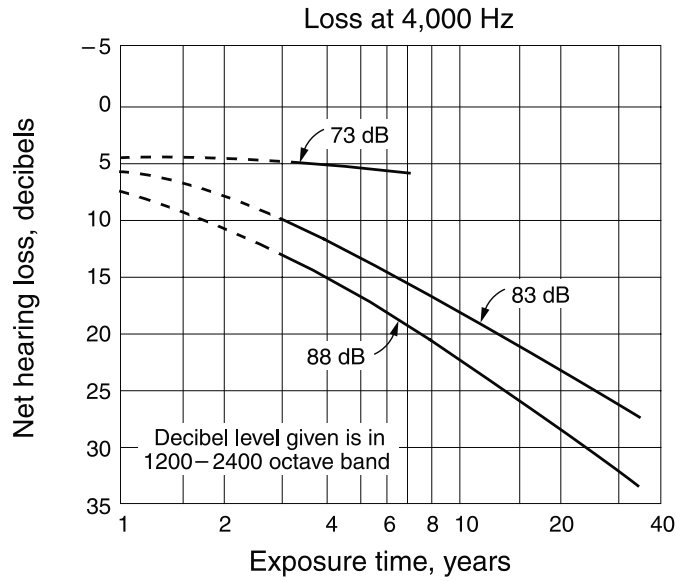
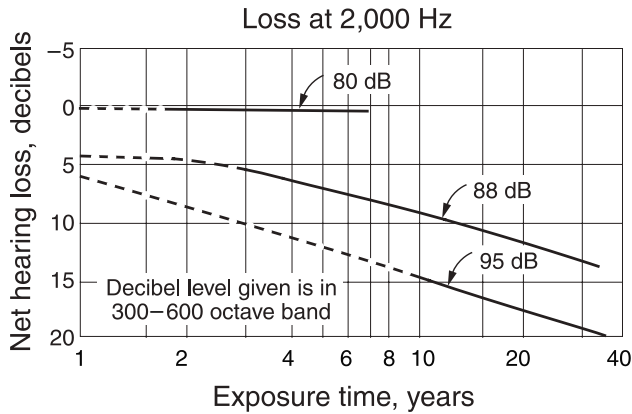
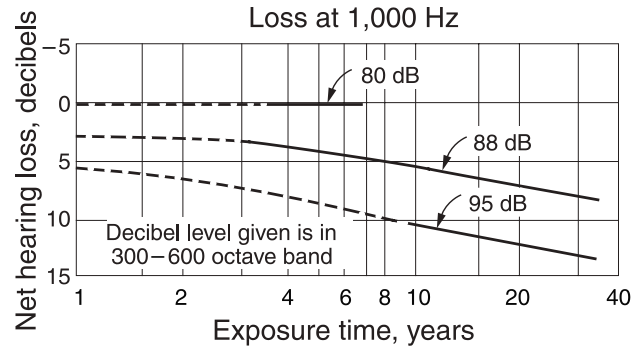

"The Relations of Hearing Loss to Noise Exposure," Exploratory Subcommittee Z24-X-2 of the American Standards Association Z24 Special Committee on Acoustics, Vibration, and Mechanical Shock, sponsored by the Acoustical Society of America, American Standards Association, 1954, pp. 31-33.

Tentative upper limit of effective temperature (ET) for unimpaired mental performance as related to exposure time; data are based on an analysis of 15 studies. Comparative curves of tolerable and marginal physiological limits are also given.

Atmospheric Conditions

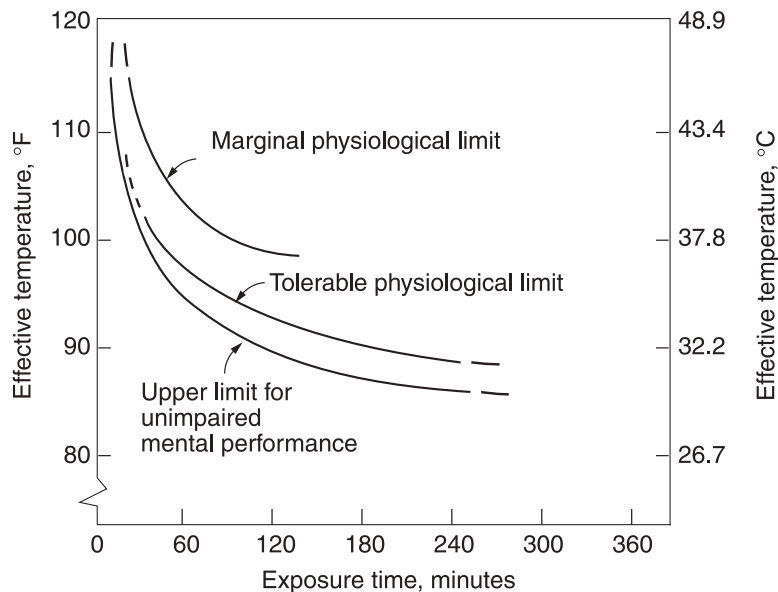

Effective temperature (ET) is the dry bulb temperature at 50% relative humidity, which results in the same physiological effect as the present conditions.

Mechanical Engineering

Mechanical Design and Analysis

Springs

Mechanical Springs

Helical Linear Springs: The shear stress in a helical linear spring is

$$\tau = K_s \frac{8FD}{\pi d^3}$$

where

d = wire diameter

F = applied force

D = mean spring diameter

$K_s = (2C + 1)/(2C)$

$C = D/d$

The deflection and force are related by $F = kx$ where the spring rate (spring constant) k is given by

$$k = \frac{d^4 G}{8D^3 N}$$

where G is the shear modulus of elasticity and N is the number of active coils.

Equivalent Spring Constant

Springs in series:

$$\frac{1}{k_{eq}} = \sum_i \frac{1}{k_i}$$

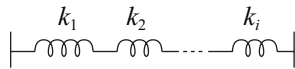

Springs in parallel:

$$k_{eq} = \sum_i k_i$$

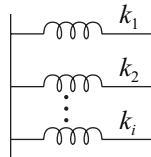

Spring Material: The minimum tensile strength of common spring steels may be determined from

$$S_{ut} = A/d^m$$

where S_{ut} is the tensile strength in MPa, d is the wire diameter in millimeters, and A and m are listed in the following table:

Material	ASTM	m	A
Music wire	A228	0.163	2060
Oil-tempered wire	A229	0.193	1610
Hard-drawn wire	A227	0.201	1510
Chrome vanadium	A232	0.155	1790
Chrome silicon	A401	0.091	1960

Maximum allowable torsional stress for static applications may be approximated as

$$S_{sy} = \tau = 0.45S_{ut} \text{ cold-drawn carbon steel (A227, A228, A229)}$$

$$S_{sy} = \tau = 0.50S_{ut} \text{ hardened and tempered carbon and low-alloy steels (A232, A401)}$$

Compression Spring Dimensions

Type of Spring Ends		
Term	Plain	Plain and Ground
End coils, N_e	0	1
Total coils, N_t	N	$N + 1$
Free length, L_0	$pN + d$	$p(N + 1)$
Solid length, L_s	$d(N_t + 1)$	dN_t
Pitch, p	$(L_0 - d)/N$	$L_0/(N + 1)$

Term	Squared or Closed	Squared and Ground
End coils, N_e	2	2
Total coils, N_t	$N + 2$	$N + 2$
Free length, L_0	$pN + 3d$	$pN + 2d$
Solid length, L_s	$d(N_t + 1)$	dN_t
Pitch, p	$(L_0 - 3d)/N$	$(L_0 - 2d)/N$

Helical Torsion Springs: The bending stress is given as

$$\sigma = K_i [32Fr/(\pi d^3)]$$

where F is the applied load and r is the radius from the center of the coil to the load.

K_i = correction factor

$$= (4C^2 - C - 1) / [4C(C - 1)]$$

$$C = D/d$$

The deflection θ and moment Fr are related by

$$Fr = k\theta$$

where the spring rate k is given by

$$k = \frac{d^4 E}{64DN}$$

where k has units of N•m/rad and θ is in radians.

Spring Material: The strength of the spring wire may be found as shown in the section on linear springs. The allowable stress σ is then given by

$$S_y = \sigma = 0.78S_{ut} \text{ cold-drawn carbon steel (A227, A228, A229)}$$

$$S_y = \sigma = 0.87S_{ut} \text{ hardened and tempered carbon and low-alloy steel (A232, A401)}$$

Bearings

Ball/Roller Bearing Selection

The minimum required *basic load rating* (load for which 90% of the bearings from a given population will survive 1 million revolutions) is given by

$$C = PL^{1/a}$$

where

C = minimum required basic load rating

P = design radial load

L = design life (in millions of revolutions)

a = 3 for ball bearings, 10/3 for roller bearings

When a ball bearing is subjected to both radial and axial loads, an equivalent radial load must be used in the equation above. The equivalent radial load is

$$P_{eq} = XVF_r + YF_a$$

where

P_{eq} = equivalent radial load

F_r = applied constant radial load

F_a = applied constant axial (thrust) load

For radial contact, deep-groove ball bearings:

$V = 1$ if inner ring rotating, 1.2 if outer ring rotating,

If $F_a/(VF_r) > e$,

$$X = 0.56, \text{ and } Y = 0.840 \left(\frac{F_a}{C_0} \right)^{-0.247}$$

where $e = 0.513 \left(\frac{F_a}{C_0} \right)^{0.236}$

C_0 = basic static load rating from bearing catalog

If $F_a/(VF_r) \leq e$, $X = 1$ and $Y = 0$.

Power Screws

Square Thread Power Screws: The torque required to raise, T_R , or to lower, T_L , a load is given by

$$T_R = \frac{Fd_m}{2} \left(\frac{l + \pi\mu d_m}{\pi d_m - \mu l} \right) + \frac{F\mu_c d_c}{2}$$

$$T_L = \frac{Fd_m}{2} \left(\frac{\pi\mu d_m - l}{\pi d_m + \mu l} \right) + \frac{F\mu_c d_c}{2}$$

where

d_c = mean collar diameter

d_m = mean thread diameter

l = lead

F = load

μ = coefficient of friction for thread

μ_c = coefficient of friction for collar

The efficiency of a power screw may be expressed as

$$\eta = Fl/(2\pi T)$$

Power Transmission

Shafts and Axles

Static Loading: The maximum shear stress and the von Mises stress may be calculated in terms of the loads from

$$\tau_{max} = \frac{2}{\pi d^3} \left[(8M + Fd)^2 + (8T)^2 \right]^{1/2}$$

$$\sigma' = \frac{4}{\pi d^3} \left[(8M + Fd)^2 + 48T^2 \right]^{1/2}$$

where

M = bending moment

F = axial load

T = torque

d = diameter

Fatigue Loading: Using the maximum-shear-stress theory combined with the Soderberg line for fatigue, the diameter and safety factor are related by

$$\frac{\pi d^3}{32} = n \left[\left(\frac{M_m}{S_y} + \frac{K_f M_a}{S_e} \right)^2 + \left(\frac{T_m}{S_y} + \frac{K_{fs} T_a}{S_e} \right)^2 \right]^{1/2}$$

where

- d = diameter
- n = safety factor
- M_a = alternating moment
- M_m = mean moment
- T_a = alternating torque
- T_m = mean torque
- S_e = fatigue limit
- S_y = yield strength
- K_f = fatigue strength reduction factor
- K_{fs} = fatigue strength reduction factor for shear

Gearing

Involute Gear Tooth Nomenclature

- Circular pitch $p_c = \pi d/N$
- Base pitch $p_b = p_c \cos \phi$
- Module $m = d/N$
- Center distance $C = (d_1 + d_2)/2$

where

- N = number of teeth on pinion or gear
- d = pitch circle diameter
- ϕ = pressure angle

Gear Trains: Velocity ratio, m_v , is the ratio of the output velocity to the input velocity. Thus, $m_v = \omega_{\text{out}}/\omega_{\text{in}}$. For a two-gear train, $m_v = -N_{\text{in}}/N_{\text{out}}$ where N_{in} is the number of teeth on the input gear and N_{out} is the number of teeth on the output gear. The negative sign indicates that the output gear rotates in the opposite sense with respect to the input gear. In a *compound gear train*, at least one shaft carries more than one gear (rotating at the same speed). The velocity ratio for a compound train is:

$$m_v = \pm \frac{\text{product of number of teeth on driver gears}}{\text{product of number of teeth on driven gears}}$$

A *simple planetary gearset* has a sun gear, an arm that rotates about the sun gear axis, one or more gears (planets) that rotate about a point on the arm, and a ring (internal) gear that is concentric with the sun gear. The planet gear(s) mesh with the sun gear on one side and with the ring gear on the other. A planetary gearset has two independent inputs and one output (or two outputs and one input, as in a differential gearset).

Often one of the inputs is zero, which is achieved by grounding either the sun or the ring gear. The velocities in a planetary set are related by

$$\frac{\omega_L - \omega_{\text{arm}}}{\omega_f - \omega_{\text{arm}}} = \pm m_v$$

where

- ω_f = speed of the first gear in the train
- ω_L = speed of the last gear in the train
- ω_{arm} = speed of the arm

Neither the first nor the last gear can be one that has planetary motion. In determining m_v , it is helpful to invert the mechanism by grounding the arm and releasing any gears that are grounded.

Dynamics of Mechanisms

Gearing

Loading on Straight Spur Gears: The load, W , on straight spur gears is transmitted along a plane that, in edge view, is called the *line of action*. This line makes an angle with a tangent line to the pitch circle that is called the *pressure angle* ϕ . Thus, the contact force has two components: one in the tangential direction, W_t , and one in the radial direction, W_r . These components are related to the pressure angle by

$$W_r = W_t \tan(\phi)$$

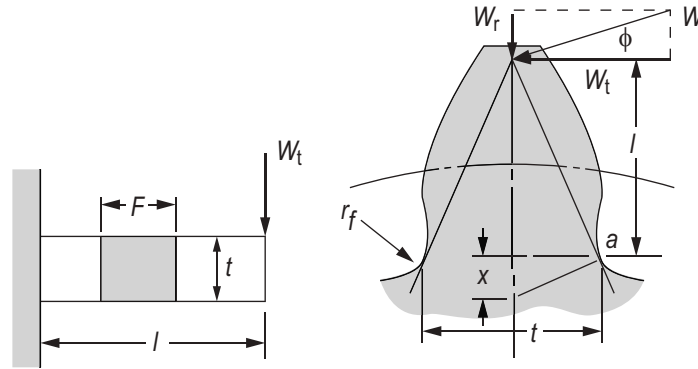

Budynas, Richard G., and J. Keith Nisbett, *Shigley's Mechanical Engineering Design*, 8th ed., New York: McGraw-Hill, 2008, p. 717.

Only the tangential component W_t transmits torque from one gear to another. Neglecting friction, the transmitted force may be found if either the transmitted torque or power is known:

$$W_t = \frac{2T}{d} = \frac{2T}{mN}$$

$$W_t = \frac{2H}{d\omega} = \frac{2H}{mN\omega}$$

where

W_t = transmitted force (newtons)

T = torque on the gear (newton-mm)

d = pitch diameter of the gear (mm)

N = number of teeth on the gear

m = gear module (mm) (same for both gears in mesh)

H = power (kW)

ω = speed of gear (rad/s)

Lewis Equation

$$\sigma = \frac{W_t P}{F Y}$$

where

$P = \frac{N}{d}$ = diameter pitch (teeth/mm)

F = face width (mm)

Y = Lewis form factor

Joining Methods

Threaded Fasteners: The load carried by a bolt in a threaded connection is given by

$$F_b = CP + F_i \quad F_m < 0$$

while the load carried by the members is

$$F_m = (1 - C)P - F_i \quad F_m < 0$$

where

$$C = \text{joint coefficient} \\ = k_b / (k_b + k_m)$$

$$F_b = \text{total bolt load}$$

$$F_i = \text{bolt preload}$$

$$F_m = \text{total material load}$$

$$P = \text{externally applied load}$$

$$k_b = \text{effective stiffness of the bolt or fastener in the grip}$$

$$k_m = \text{effective stiffness of the members in the grip}$$

Bolt stiffness may be calculated from

$$k_b = \frac{A_d A_t E}{A_d l_t + A_t l_d}$$

where

$$A_d = \text{major-diameter area}$$

$$A_t = \text{tensile-stress area}$$

$$E = \text{modulus of elasticity}$$

$$l_d = \text{length of unthreaded shank}$$

$$l_t = \text{length of threaded shank contained within the grip}$$

If all members within the grip are of the same material, *member stiffness* may be obtained from

$$k_m = dEAe^{b(d/l)}$$

where

$$d = \text{bolt diameter}$$

$$E = \text{modulus of elasticity of members}$$

$$l = \text{grip length}$$

Coefficients A and b are given in the table below for various joint member materials.

Material	A	b
Steel	0.78715	0.62873
Aluminum	0.79670	0.63816
Copper	0.79568	0.63553
Gray cast iron	0.77871	0.61616

The approximate tightening torque required for a given preload F_i and for a steel bolt in a steel member is given by $T = 0.2 F_i d$.

Threaded Fasteners – Design Factors: The bolt load factor is

$$n_b = (S_p A_t - F_i) / CP$$

where

$$S_p = \text{proof strength}$$

The factor of safety guarding against joint separation is

$$n_s = F_i / [P(1 - C)]$$

Threaded Fasteners – Fatigue Loading: If the externally applied load varies between zero and P , the alternating stress is

$$\sigma_a = CP/(2A_t)$$

and the mean stress is

$$\sigma_m = \sigma_a + F_i/A_t$$

Bolted and Riveted Joints Loaded in Shear:

Failure by Pure Shear



$$\tau = F/A$$

where

F = shear load

A = cross-sectional area of bolt or rivet

Failure by Rupture

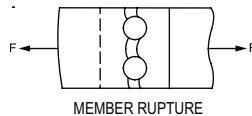

$$\sigma = F/A$$

where

F = load

A = net cross-sectional area of thinnest member

Failure by Crushing of Rivet or Fastener



$$\sigma = F/A$$

where

F = load

$A = (d)(t)$ = projected area of a single rivet or fastener

where

d = projected diameter of rivet

t = thickness of thinnest plate

Fastener Groups in Shear

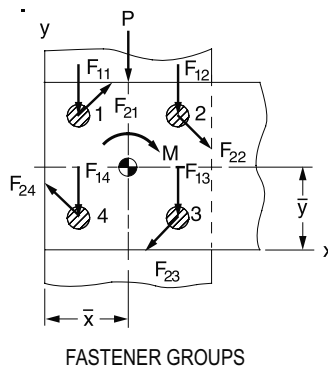

The location of the centroid of a fastener group with respect to any convenient coordinate frame is:

$$\bar{x} = \frac{\sum_{i=1}^n A_i x_i}{\sum_{i=1}^n A_i}, \quad \bar{y} = \frac{\sum_{i=1}^n A_i y_i}{\sum_{i=1}^n A_i}$$

where

- n = total number of fasteners
- i = the index number of a particular fastener
- A_i = cross-sectional area of the i th fastener
- x_i = x-coordinate of the center of the i th fastener
- y_i = y-coordinate of the center of the i th fastener

The total shear force on a fastener is the **vector** sum of the force due to direct shear P and the force due to the moment M acting on the group at its centroid.

The magnitude of the direct shear force due to P is

$$|F_{1i}| = \frac{P}{n}.$$

This force acts in the same direction as P .

The magnitude of the shear force due to M is

$$|F_{2i}| = \frac{Mr_i}{\sum_{i=1}^n r_i^2}.$$

This force acts perpendicular to a line drawn from the group centroid to the center of a particular fastener. Its sense is such that its moment is in the same direction (CW or CCW) as M .

Press/Shrink Fits

The interface pressure induced by a press/shrink fit is

$$p = \frac{0.5\delta}{\frac{r}{E_o} \left(\frac{r_o^2 + r^2}{r_o^2 - r^2} + \nu_o \right) + \frac{r}{E_i} \left(\frac{r^2 + r_i^2}{r^2 - r_i^2} - \nu_i \right)}$$

where the subscripts i and o stand for the inner and outer member, respectively, and

- p = inside pressure on the outer member and outside pressure on the inner member
- δ = diametral interference
- r = nominal interference radius
- r_i = inside radius of inner member
- r_o = outside radius of outer member
- E = Young's modulus of respective member
- ν = Poisson's ratio of respective member

The *maximum torque* that can be transmitted by a press fit joint is approximately

$$T = 2\pi r^2 \mu p l,$$

where r and p are defined above,

- T = torque capacity of the joint
- μ = coefficient of friction at the interface
- l = length of hub engagement

Manufacturability

Limits and Fits

The designer is free to adopt any geometry of fit for shafts and holes that will ensure intended function. Over time, sufficient experience with common situations has resulted in the development of a standard. The metric version of the standard is newer and will be presented. The standard specifies that uppercase letters always refer to the hole, while lowercase letters always refer to the shaft.

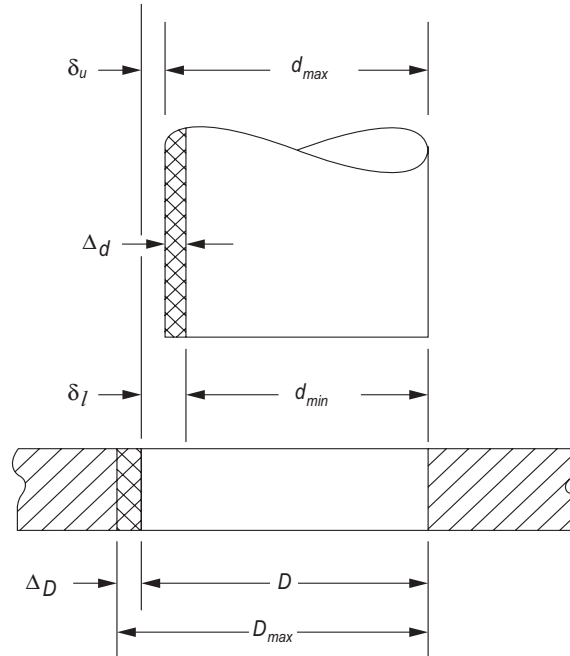

Definitions

Basic Size or *nominal size*, D or d , is the size to which the limits or deviations are applied. It is the same for both components.

Deviation is the algebraic difference between the actual size and the corresponding basic size.

Upper Deviation, δ_u , is the algebraic difference between the maximum limit and the corresponding basic size.

Lower Deviation, δ_l , is the algebraic difference between the minimum limit and the corresponding basic size.

Fundamental Deviation, δ_F , is the upper or lower deviation, depending on which is closer to the basic size.

Tolerance, Δ_D or Δ_d , is the difference between the maximum and minimum size limits of a part.

International tolerance (IT) grade numbers designate groups of tolerances such that the tolerance for a particular IT number will have the same relative accuracy for a basic size.

Hole basis represents a system of fits corresponding to a basic hole size. The fundamental deviation is H .

Some Preferred Fits

Clearance	
<i>Free running fit</i> : not used where accuracy is essential but good for large temperature variations, high running speeds, or heavy journal loads.	H9/d9
<i>Sliding fit</i> : where parts are not intended to run freely but must move and turn freely and locate accurately.	H7/g6
<i>Locational clearance fit</i> : provides snug fit for location of stationary parts, but can be freely assembled and disassembled.	H7/h6
<i>Loose running fit</i> : for wide commercial tolerances or allowances on external members	H11/c11
<i>Close running fit</i> : for running on accurate machines and for accurate location at moderate speeds and journal pressures	H8/f7
Transition	
<i>Locational transition fit</i> : for accurate location, a compromise between clearance and interference	H7/k6
<i>Locational transition fit</i> : for more accurate location where greater interface is permissible	H7/n6
Interference	
<i>Location interference fit</i> : for parts requiring rigidity and alignment with prime accuracy of location but without special bore pressure requirements.	H7/p6
<i>Medium drive fit</i> : for ordinary steel parts or shrink fits on light sections. The tightest fit usable on cast iron.	H7/s6
<i>Force fit</i> : suitable for parts which can be highly stressed or for shrink fits where the heavy pressing forces required are impractical.	H7/u6

For the hole

$$D_{\max} = D + \Delta_D$$

$$D_{\min} = D$$

For a shaft with clearance fits d , g , h , c , or f

$$d_{\max} = d + \delta_F$$

$$d_{\min} = d_{\max} - \Delta_d$$

For a shaft with transition or interference fits $k, p, s, u,$ or n

$$d_{\min} = d + \delta_F$$

$$d_{\max} = d_{\min} + \Delta_d$$

where

D = basic size of hole

d = basic size of shaft

δ_u = upper deviation

δ_l = lower deviation

δ_F = fundamental deviation

Δ_D = tolerance grade for hole

Δ_d = tolerance grade for shaft

International Tolerance (IT) Grades

Lower limit < Basic Size ≤ Upper Limit
All values in mm

Basic Size	Tolerance Grade, (Δ_D or Δ_d)		
	IT6	IT7	IT9
0–3	0.006	0.010	0.025
3–6	0.008	0.012	0.030
6–10	0.009	0.015	0.036
10–18	0.011	0.018	0.043
18–30	0.013	0.021	0.052
30–50	0.016	0.025	0.062

Source: Preferred Metric Limits and Fits, ANSI B4.2-1978

Deviations for Shafts

Lower limit < Basic Size ≤ Upper Limit
All values in mm

Basic Size	Upper Deviation Letter, (δ_u)					Lower Deviation Letter, (δ_l)				
	c	d	f	g	h	k	n	p	s	u
0–3	-0.060	-0.020	-0.006	-0.002	0	0	+0.004	+0.006	+0.014	+0.018
3–6	-0.070	-0.030	-0.010	-0.004	0	+0.001	+0.008	+0.012	+0.019	+0.023
6–10	-0.080	-0.040	-0.013	-0.005	0	+0.001	+0.010	+0.015	+0.023	+0.028
10–14	-0.095	-0.050	-0.016	-0.006	0	+0.001	+0.012	+0.018	+0.028	+0.033
14–18	-0.095	-0.050	-0.016	-0.006	0	+0.001	+0.012	+0.018	+0.028	+0.033
18–24	-0.110	-0.065	-0.020	-0.007	0	+0.002	+0.015	+0.022	+0.035	+0.041
24–30	-0.110	-0.065	-0.020	-0.007	0	+0.002	+0.015	+0.022	+0.035	+0.048
30–40	-0.120	-0.080	-0.025	-0.009	0	+0.002	+0.017	+0.026	+0.043	+0.060
40–50	-0.130	-0.080	-0.025	-0.009	0	+0.002	+0.017	+0.026	+0.043	+0.070

Source: ASME B4.2:2009

As an example, 34H7/s6 denotes a basic size of $D = d = 34$ mm, an IT class of 7 for the hole, and an IT class of 6 and an "s" fit class for the shaft.

Geometric Dimensioning and Tolerancing (GD&T)

GD&T is used to communicate design intent. This reference provides materials drawn from the ASME Y14.5 standard: "GD&T is an essential tool for communicating design intent—that parts from technical drawings have the desired form, fit, function and interchangeability."

GD&T helps the designer provide information about the size, geometry, and location of features for mechanical parts.

Definitions used in ASME Y14.5

Regardless of Feature Size (RFS)

This is the default condition for geometric tolerances.

Least Material Condition (LMC)

This is a modifier for the geometric tolerance. The modifier defines the tolerance or acceptability where the part has the least amount of material or weighs the least.

Maximum Material Condition (MMC)

This is a modifier for the geometric tolerance. The modifier defines the tolerance or acceptability where the part has the most amount of material or weighs the most.

Feature Control Frame

From the ASME Y14.5:2009 standard: "A feature control frame is a rectangle divided into compartments containing the geometric characteristic symbol followed by the tolerance value or description, modifiers, and any applicable datum reference features."











Datum

A datum is a plane, axis, point, or other reference geometry with respect to which the tolerance is specified.

Virtual Condition

The virtual condition is used to determine the clearance between mating parts. For an external feature, the virtual condition is equal to the MMC plus the related geometric tolerance. For an internal feature, it is equal to the MMC minus the related geometric tolerance.

Modifying Symbols

Term	Symbol	Definitions
AT MAXIMUM MATERIAL CONDITION (When applied to a tolerance value) AT MAXIMUM MATERIAL BOUNDARY (When applied to a datum reference)		The condition in which a feature of size contains the maximum amount of material within the stated limits of size, e.g., minimum hole diameter or maximum shaft diameter.
AT LEAST MATERIAL CONDITION (When applied to a tolerance value) AT LEAST MATERIAL BOUNDARY (When applied to a datum reference)		An MMB and an LMB, where at least one boundary is a specified shape that is not a uniform offset from true profile.
PROJECTED TOLERANCE ZONE		The symbolic means of indicating a projected tolerance zone.
DIAMETER		The symbols used to indicate diameter, spherical diameter, radius, spherical radius, and controlled radius shall precede the value of a dimension or tolerance given as a diameter or radius, as applicable.
SPHERICAL DIAMETER		
RADIUS		
SPHERICAL RADIUS		
SQUARE		Feature nominal size is square.
REFERENCE		The symbolic means of indicating a dimension or other dimensional data as reference shall be to enclose the dimension (or dimensional data) within parentheses.
ARC LENGTH		The symbolic means of indicating a dimension is an arch length measured on a curved outline.
DIMENSION ORIGIN		The symbolic means of indicating a toleranced dimension between two features originates from one of these features and not the other.

Adapted from ASME Y14.5–2018, American Society of Mechanical Engineers, 2018.

Geometric Dimensioning and Tolerancing (GD&T)

Tolerance Types	ASME Symbol	Drawing Callout Example	Drawing Callout Meaning	Tolerance Zone Definition (for Example)	Zone Modifiers Allowed	Datums Used	Additional Comments
Form	Straightness			Parallel lines, within which the surface element must lie	No (Surface)	No	<input type="checkbox"/> Refinement of size. <input type="checkbox"/> Tolerance value must be less than the size tolerance.
				Cylindrical boundary, within which the axis of the feature must lie (derived median line)	Yes (Axis)	No	<input type="checkbox"/> Not a refinement of size. <input type="checkbox"/> Rule #1 only applies to each circular element. <input type="checkbox"/> MMC or RFS only. <input type="checkbox"/> Where necessary the geometric tolerance may be greater than the size tolerance.
	Flatness			Parallel planes, within which the elements of a surface must lie	No	No	<input type="checkbox"/> Refinement of size. <input type="checkbox"/> Tolerance value must be less than the size tolerance.
		Circularity			Concentric circles, within which each circular element of the surface must lie	No	No
Cylindricity				Concentric cylinders, within which all surface elements must lie	No	No	<input type="checkbox"/> Refinement of size. <input type="checkbox"/> Tolerance value must be less than the size tolerance. <input type="checkbox"/> Cylindricity is a composite control of form which includes circularity, straightness and taper of a cylindrical feature.
	Profile	Profile of a Surface			A uniform boundary equally disposed along the true (theoretically exact) profile within which the elements of the surface must lie	No	Yes
				Parallel planes, within which the elements of both surfaces must lie simultaneously	No	No (In this example)	<input type="checkbox"/> Used as a refinement of size, the profile tolerance must be contained within the size limits. <input type="checkbox"/> Also controls flatness of each individual surface. <input type="checkbox"/> If a datum was used with a linear dimension it would also control parallelism. <input type="checkbox"/> Datum with a basic dimension would control the tolerance around the true profile.
Profile of a Line				A uniform boundary equally disposed along the true (theoretically exact) profile, within which the surface elements of each cross-section must lie	No	No (In this example)	<input type="checkbox"/> Used to control form, or combination of size, form, orientation, and location. <input type="checkbox"/> Tolerance zone can be bilateral or unilateral. <input type="checkbox"/> Can be used as refinement of size. <input type="checkbox"/> Datums can be used where necessary to define design intent differently.

Geometric Dimensioning and Tolerancing (GD&T)
(continued)

Tolerance Types	ASME Symbol	Drawing Callout Example	Drawing Callout Meaning	Tolerance Zone Definition (for Example)	Zone Modifiers Allowed	Datums Used	Additional Comments
Orientation	Angularity			Parallel planes, at a specified basic angle from a datum plane(s) within which all surface elements must lie	No (Surface)	Yes	<ul style="list-style-type: none"> Also controls surface flatness. A basic angle must be used from the tolerated feature to the datum reference. MMC can be used when angularity is applied to an axis or centerplane of a feature.
	Perpendicularity			Parallel planes, at 90 degrees basic (perpendicular) to a datum plane(s) within which the elements of a surface must lie	No (Surface)	Yes	<ul style="list-style-type: none"> A refinement of size. Also controls surface flatness.
				Cylindrical boundary, at 90 degrees basic (perpendicular) to a datum plane within which the axis of the feature must lie	Yes (Axis)	Yes	<ul style="list-style-type: none"> Not a refinement of size. Hole must also be within size limits. Calculation
Parallelism			Parallel planes, parallel to a datum plane (or axis) within which the elements of a surface must lie	No (Surface)	Yes	<ul style="list-style-type: none"> Refinement of size. Also controls surface flatness. Can be applied to an axis of a feature in which the zone could be parallel planes or a cylindrical tolerance zone. MMC can be used when parallelism is applied to an axis or centerplane of a feature. 	
Location	Position			Cylindrical boundary, within which the center axis of a cylindrical feature of size is permitted to vary from the true (theoretically exact) position	Yes	Yes	<ul style="list-style-type: none"> Primary control for features of size. Tolerance zone also defines the limits of variation in attitude (perpendicularity) of the axis of a cylinder or slot in relationship to a datum(s). Where feature control frames contain the same datums in the same order of precedence with the same modifying symbols, they are considered a single composite pattern. If not required, it must state 'SEPARATE REQUIREMENT.'
				Parallel planes, within which the center plane of a slot is permitted to vary from the true (theoretically exact) position	Yes	Yes	
	Concentricity			Cylindrical boundary, within which the axis of all cross-sectional elements of a surface of revolution are common to the axis of the datum feature	No	Yes	<ul style="list-style-type: none"> Median points to axis control. The specified tolerance and the datum reference apply only on an RFS basis. Used primarily for dynamically balanced comp. Involves complex analysis of the surface to determine axis location. Consider using position or profile before specifying concentricity.
	Symmetry			Parallel planes, within which the median points of all opposed or correspondingly located elements of a surface(s) are common to the center plane of the datum feature	No	Yes	<ul style="list-style-type: none"> The specified tolerance and the datum reference apply only on an RFS basis. Involves complex analysis of the surface to determine location. Consider using position or profile before specifying symmetry.
	Runout	Circular Runout			Two concentric circles, within which each circular element must lie in relationship to the datum axis	No	Yes
Total Runout				Two concentric cylinders, within which all circular elements must lie (simultaneously) in relationship to the datum axis	No	Yes	<ul style="list-style-type: none"> An axis to surface control. Provides composite control of all surface elements. Used to control cumulative variations of circularity, straightness, taper, and axis offset. Datum applied on an RFS basis only.
Rule #1 Individual Feature of Size Where only a tolerance of size is specified, the limits of size of an individual feature prescribe the extent to which variations in its geometric form, as well as size, are allowed.	<p>Variations of Form (Envelope Principle) A feature shall not extend beyond a boundary (envelope) of perfect form at MMC.</p>			<p>Variations of Size The actual local size of an individual feature at each cross section shall be within the specified tolerance of size.</p> <p>Perfect Form at MMC Not Required Where it is desired to permit a surface or surfaces of a feature to exceed the boundary of perfect form at MMC, a note such as PERFECT FORM AT MMC NOT REQUIRED is specified.</p>			Rule #2 All Applicable Geometric Tolerances RFS applies, with respect to the individual tolerance, datum reference, or both, where no modifying symbol is specified. MMC and LMC must be specified on the drawing where it is required.

Intermediate- and Long-Length Columns

For both intermediate and long columns, the effective column length depends on the end conditions. The AISC recommended design values for the effective lengths of columns are, for: rounded-rounded or pinned-pinned ends,

$l_{eff} = l$; fixed-free, $l_{eff} = 2.1l$; fixed-pinned, $l_{eff} = 0.80l$; fixed-fixed, $l_{eff} = 0.65l$. The effective column length should be used when calculating the slenderness ratio.

The slenderness ratio of a column is $S_r = l/r$, where l is the length of the column and r is the radius of gyration. The radius of gyration of a column cross-section is, $r = \sqrt{I/A}$ where I is the area moment of inertia and A is the cross-sectional area of the column. A column is considered to be intermediate if its slenderness ratio is less than or equal to $(S_r)_D$, where

$$(S_r)_D = \pi \sqrt{\frac{2E}{S_y}}, \text{ and}$$

E = Young's modulus of respective member

S_y = yield strength of the column material

For intermediate columns, the critical load is

$$P_{cr} = A \left[S_y - \frac{1}{E} \left(\frac{S_y S_r}{2\pi} \right)^2 \right]$$

where

P_{cr} = critical buckling load

A = cross-sectional area of the column

S_y = yield strength of the column material

E = Young's modulus of respective member

S_r = slenderness ratio

For long columns, the critical load is

$$P_{cr} = \frac{\pi^2 EA}{S_r^2}$$

where the variables are as defined above.

Static Loading Failure Theories

Brittle Materials

Maximum-Normal-Stress Theory

The maximum-normal-stress theory states that failure occurs when one of the three principal stresses equals the strength of the material. If $\sigma_1 \geq \sigma_2 \geq \sigma_3$, then the theory predicts that failure occurs whenever $\sigma_1 \geq S_{ut}$ or $\sigma_3 \leq -S_{uc}$ where S_{ut} and S_{uc} are the tensile and compressive strengths, respectively.

Coulomb-Mohr Theory

The Coulomb-Mohr theory is based upon the results of tensile and compression tests. On the σ, τ coordinate system, one circle is plotted for S_{ut} and one for S_{uc} . As shown in the figure, lines are then drawn tangent to these circles. The Coulomb-Mohr theory then states that fracture will occur for any stress situation that produces a circle that is either tangent to or crosses the envelope defined by the lines tangent to the S_{ut} and S_{uc} circles.

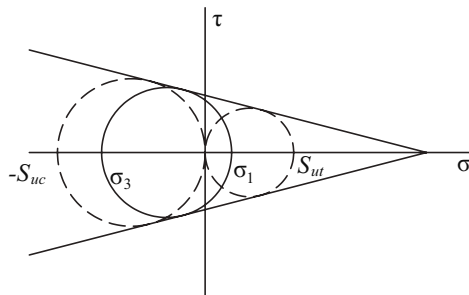

If $\sigma_1 \geq \sigma_2 \geq \sigma_3$ and $\sigma_3 < 0$, then the theory predicts that yielding will occur whenever

$$\frac{\sigma_1}{S_{ut}} - \frac{\sigma_3}{S_{uc}} \geq 1$$

Ductile Materials

Maximum-Shear-Stress Theory

The maximum-shear-stress theory states that yielding begins when the maximum shear stress equals the maximum shear stress in a tension-test specimen of the same material when that specimen begins to yield. If $\sigma_1 \geq \sigma_2 \geq \sigma_3$, then the theory predicts that yielding will occur whenever $\tau_{\max} \geq S_y/2$ where S_y is the yield strength.

$$\tau_{\max} = \frac{\sigma_1 - \sigma_3}{2}$$

Distortion-Energy Theory

The distortion-energy theory states that yielding begins whenever the distortion energy in a unit volume equals the distortion energy in the same volume when uniaxially stressed to the yield strength. The theory predicts that yielding will occur whenever

$$\left[\frac{(\sigma_1 - \sigma_2)^2 + (\sigma_2 - \sigma_3)^2 + (\sigma_1 - \sigma_3)^2}{2} \right]^{1/2} \geq S_y$$

The term on the left side of the inequality is known as the effective or Von Mises stress. For a biaxial stress state the effective stress becomes

$$\sigma' = (\sigma_A^2 - \sigma_A \sigma_B + \sigma_B^2)^{1/2}$$

or

$$\sigma' = (\sigma_x^2 - \sigma_x \sigma_y + \sigma_y^2 + 3\tau_{xy}^2)^{1/2}$$

where σ_A and σ_B are the two nonzero principal stresses and σ_x , σ_y , and τ_{xy} are the stresses in orthogonal directions.

Variable Loading Failure Theories

Modified Goodman Theory

The modified Goodman criterion states that a fatigue failure will occur whenever

$$\frac{\sigma_a}{S_e} + \frac{\sigma_m}{S_{ut}} \geq 1 \quad \text{or} \quad \frac{\sigma_{\max}}{S_y} \geq 1, \quad \sigma_m \geq 0, \quad (\text{without a factor of safety})$$

$$\frac{\sigma_a}{S_e} + \frac{\sigma_m}{S_{ut}} \geq \frac{1}{n} \quad \text{or} \quad \frac{\sigma_{\max}}{S_y} \geq \frac{1}{n}, \quad \sigma_m \geq 0 \quad (\text{with a factor of safety})$$

where

S_e = endurance limit

S_{ut} = ultimate strength

S_y = yield strength

σ_a = alternating stress

σ_m = mean stress

$\sigma_{\max} = \sigma_m + \sigma_a$

n = factor of safety

Soderberg Theory

The Soderberg theory states that a fatigue failure will occur whenever

$$\frac{\sigma_a}{S_e} + \frac{\sigma_m}{S_y} \geq 1 \quad \sigma_m \geq 0$$

Endurance Limit for Steels

When test data is unavailable, the endurance limit for steels may be estimated as

$$S'_e = \begin{cases} 0.5 S_{ut}, S_{ut} \leq 1,400 \text{ MPa} \\ 700 \text{ MPa}, S_{ut} > 1,400 \text{ MPa} \end{cases}$$

Endurance Limit Modifying Factors

Endurance limit modifying factors are used to account for the differences between the endurance limit as determined from a rotating beam test, S'_e , and that which would result in the real part, S_e .

$$S_e = k_a k_b k_c k_d k_e S'_e$$

where

Surface Factor, $k_a = aS_{ut}^b$

Surface Finish	Factor a		Exponent b
	kpsi	MPa	
Ground	1.34	1.58	-0.085
Machined or CD	2.70	4.51	-0.265
Hot rolled	14.4	57.7	-0.718
As forged	39.9	272.0	-0.995

Size Factor, k_b :

For bending and torsion:

$d \leq 8 \text{ mm}; \quad k_b = 1$

$8 \text{ mm} \leq d \leq 250 \text{ mm}; \quad k_b = 1.189d_{eff}^{-0.097}$

$d > 250 \text{ mm}; \quad 0.6 \leq k_b \leq 0.75$

For axial loading: $k_b = 1$

Load Factor, k_c :

$k_c = 0.923$ axial loading, $S_{ut} \leq 1,520 \text{ MPa}$

$k_c = 1$ axial loading, $S_{ut} > 1,520 \text{ MPa}$

$k_c = 1$ bending

$k_c = 0.577$ torsion

Temperature Factor, k_d :

for $T \leq 450^\circ\text{C}$, $k_d = 1$

Miscellaneous Effects Factor, k_e : Used to account for strength reduction effects such as corrosion, plating, and residual stresses. In the absence of known effects, use $k_e = 1$.

Kinematics, Dynamics, and Vibrations

Kinematics of Mechanisms

Four-Bar Linkage

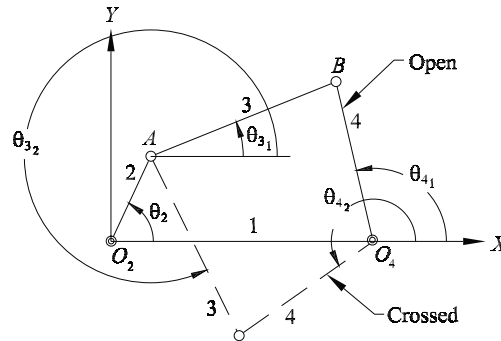

The four-bar linkage shown above consists of a reference (usually grounded) link (1), a crank (input) link (2), a coupler link (3), and an output link (4). Links 2 and 4 rotate about the fixed pivots O_2 and O_4 , respectively. Link 3 is joined to link 2 at the moving pivot A and to link 4 at the moving pivot B . The lengths of links 2, 3, 4, and 1 are a , b , c , and d , respectively.

Taking link 1 (ground) as the reference (X -axis), the angles that links 2, 3, and 4 make with the axis are θ_2 , θ_3 , and θ_4 , respectively. It is possible to assemble a four-bar in two different configurations for a given position of the input link (2). These are known as the "open" and "crossed" positions or circuits.

Position Analysis. Given a , b , c , and d , and θ_2

$$\theta_{4,2} = 2 \arctan \left(\frac{-B \pm \sqrt{B^2 - 4AC}}{2A} \right)$$

where

$$A = \cos \theta_2 - K_1 - K_2 \cos \theta_2 + K_3$$

$$B = -2 \sin \theta_2$$

$$C = K_1 - (K_2 + 1) \cos \theta_2 + K_3$$

$$K_1 = \frac{d}{a}, K_2 = \frac{d}{c}, K_3 = \frac{a^2 - b^2 + c^2 + d^2}{2ac}$$

In the equation for θ_4 , using the minus sign in front of the radical yields the open solution. Using the plus sign yields the crossed solution.

$$\theta_{3,2} = 2 \arctan \left(\frac{-E \pm \sqrt{E^2 - 4DF}}{2D} \right)$$

where

$$D = \cos \theta_2 - K_1 + K_4 \cos \theta_2 + K_5$$

$$E = -2 \sin \theta_2$$

$$F = K_1 + (K_4 - 1) \cos \theta_2 + K_5$$

$$K_4 = \frac{d}{b}, K_5 = \frac{c^2 - d^2 - a^2 - b^2}{2ab}$$

In the equation for θ_3 , using the minus sign in front of the radical yields the open solution. Using the plus sign yields the crossed solution.

Velocity Analysis. Given a , b , c , and d , θ_2 , θ_3 , θ_4 , and ω_2

$$\omega_3 = \frac{a\omega_2 \sin(\theta_4 - \theta_2)}{b \sin(\theta_3 - \theta_4)}$$

$$\omega_4 = \frac{a\omega_2 \sin(\theta_2 - \theta_3)}{c \sin(\theta_4 - \theta_3)}$$

$$V_{Ax} = -a\omega_2 \sin \theta_2, \quad V_{Ay} = a\omega_2 \cos \theta_2$$

$$V_{BAx} = -b\omega_3 \sin \theta_3, \quad V_{BAy} = b\omega_3 \cos \theta_3$$

$$V_{Bx} = -c\omega_4 \sin \theta_4, \quad V_{By} = c\omega_4 \cos \theta_4$$

Acceleration Analysis. Given a , b , c , and d , θ_2 , θ_3 , θ_4 , and ω_2 , ω_3 , ω_4 , and α_2

$$\alpha_3 = \frac{CD - AF}{AE - BD}, \quad \alpha_4 = \frac{CE - BF}{AE - BD}$$

$$A = c \sin \theta_4, \quad B = b \sin \theta_3$$

$$C = a\alpha_2 \sin \theta_2 + a\omega_2^2 \cos \theta_2 + b\omega_3^2 \cos \theta_3 - c\omega_4^2 \cos \theta_4$$













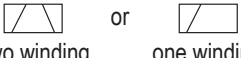





















$$D = c \cos \theta_4, \quad E = b \cos \theta_3$$

$$F = a\alpha_2 \cos \theta_2 - a\omega_2^2 \sin \theta_2 - b\omega_3^2 \sin \theta_3 + c\omega_4^2 \sin \theta_4$$

Mechanical Engineering

Symbols commonly used to represent hydraulic pneumatic and electromechanical components.

ANSI Symbols for Hydraulic Power

 (a) spring (spring-loaded)	 (m) hydraulic motor, fixed capacity (two directions of flow)	 (y) flow control valve
 two winding or one winding (b) solenoid	 (n) hydraulic motor, variable capacity (one direction of flow)	 (z) shut-off valve
 (c) adjustable symbol	 (o) actuating cylinder (single acting)	 (aa) electric motor
 (d) directional arrow (oil)	 (p) actuating cylinder (double acting)	 (bb) internal combustion engine
 (e) directional arrow (air or gas)	 (q) two-way, two-position control valve (normally closed)	 (cc) coupling
 (f) fluid line flow	 (r) two-way, two-position control valve (normally open)	 (dd) accumulator
 (g) shaft or lever	 (s) three-way, two-position control valve (normally open)	 (ee) cooler
 (h) reservoir (open)	 (t) four-way, two-position control valve	 (ff) heater
 (i) reservoir (closed)	 (u) check (nonreturn) valve	 (gg) pressure gage
 (j) filter or strainer	 (v) shuttle valve	 (hh) temperature gage
 (k) pump, fixed capacity (one direction of flow)	 (w) pressure control valve	 (ii) flow meter
 (l) pump, variable capacity (two directions of flow)	 (x) pressure relief valve	

Source: MIL-TD-17B-1: *Military Standard Mechanical Symbols*, Washington, DC: U.S. Department of Defense, 1963.

HVAC

Nomenclature

h = specific enthalpy

h_f = specific enthalpy of saturated liquid

\dot{m}_a = mass flowrate of dry air

\dot{m}_w = mass flowrate of water

\dot{Q} = rate of heat transfer

T_{wb} = wet bulb temperature

ω = specific humidity (absolute humidity, humidity ratio)

HVAC—Pure Heating and Cooling

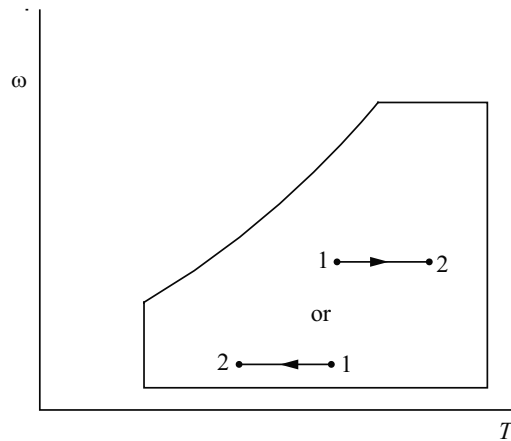
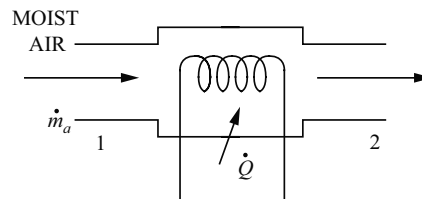

$$\dot{Q} = \dot{m}_a(h_2 - h_1)$$

Cooling and Dehumidification

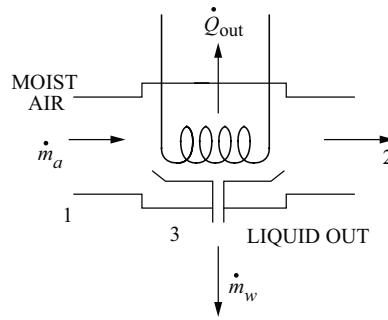

$$\dot{Q}_{out} = \dot{m}_a [(h_1 - h_2) - h_{f3} (\omega_1 - \omega_2)]$$

$$\dot{m}_w = \dot{m}_a (\omega_1 - \omega_2)$$

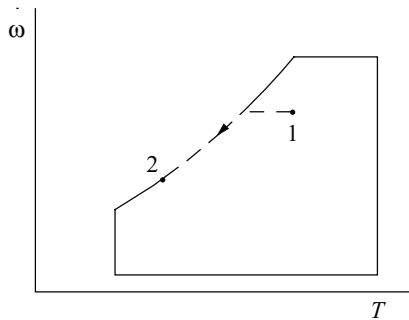

Heating and Humidification

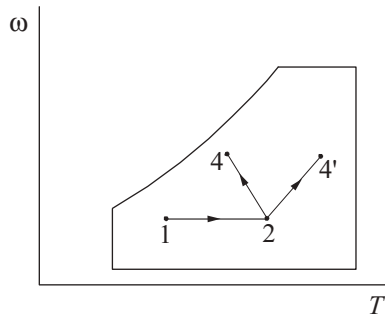
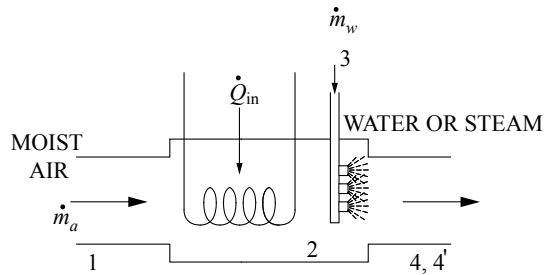

$$\dot{Q}_{in} = \dot{m}_a (h_2 - h_1)$$

$$\dot{m}_w = \dot{m}_a (\omega_{4'} - \omega_2) \text{ or } \dot{m}_w = \dot{m}_a (\omega_4 - \omega_2)$$

Adiabatic Humidification (evaporative cooling)

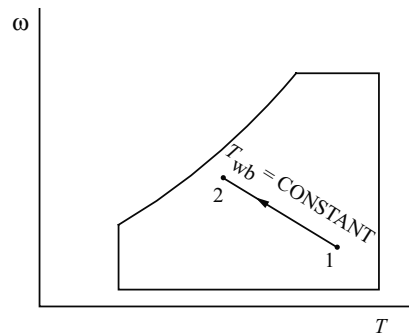
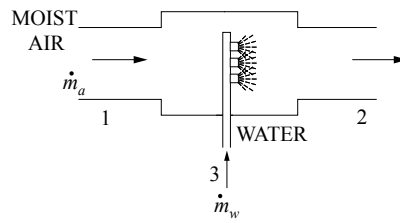

$$h_2 = h_1 + h_3(\omega_2 - \omega_1)$$

$$\dot{m}_w = \dot{m}_a(\omega_2 - \omega_1)$$

$$h_3 = h_f \text{ at } T_{wb}$$

Adiabatic Mixing

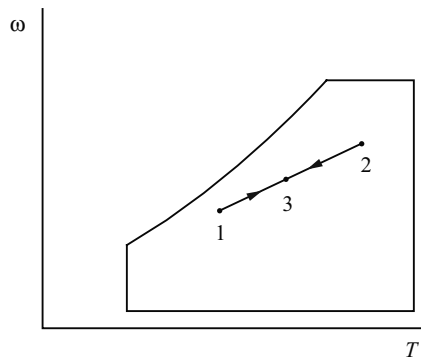
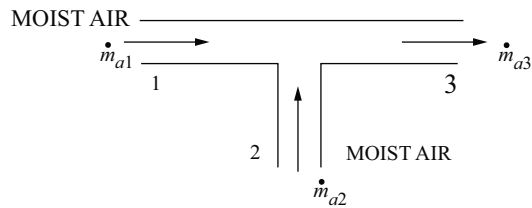

$$\dot{m}_{a3} = \dot{m}_{a1} + \dot{m}_{a2}$$

$$h_3 = \frac{\dot{m}_{a1}h_1 + \dot{m}_{a2}h_2}{\dot{m}_{a3}}$$

$$\omega_3 = \frac{\dot{m}_{a1}\omega_1 + \dot{m}_{a2}\omega_2}{\dot{m}_{a3}}$$

Cycles and Processes

Internal Combustion Engines

Diesel Cycle

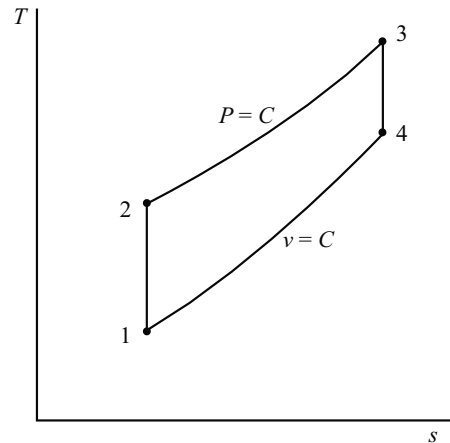
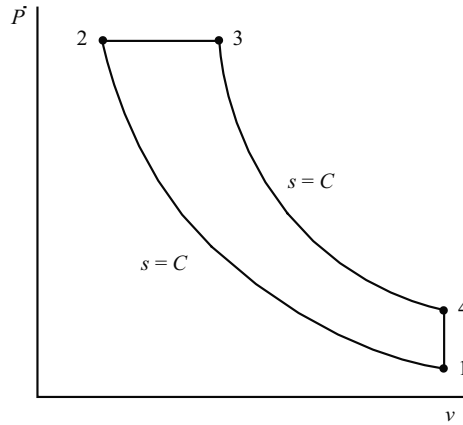

$$r = V_1/V_2$$

$$r_c = V_3/V_2$$

$$\eta = 1 - \frac{1}{r^{k-1}} \left[\frac{r_c^k - 1}{k(r_c - 1)} \right] \quad (\text{cold air standard})$$

$$k = c_p/c_v$$

Brake Power

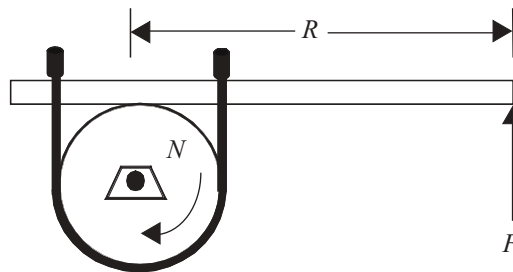

$$\dot{W}_b = 2\pi TN = 2\pi FRN$$

where

\dot{W}_b = brake power (W)

T = torque (N•m)

N = rotation speed (rev/s)

F = force at end of brake arm (N)

R = length of brake arm (m)

Indicated Power

$$\dot{W}_i = \dot{W}_b + \dot{W}_f$$

where

\dot{W}_i = indicated power (W)

\dot{W}_f = friction power (W)

Brake Thermal Efficiency

$$\eta_b = \frac{\dot{W}_b}{\dot{m}_f(HV)}$$

where

η_b = brake thermal efficiency

\dot{m}_f = fuel consumption rate (kg/s)

HV = heating value of fuel (J/kg)

Indicated Thermal Efficiency

$$\eta_i = \frac{\dot{W}_i}{\dot{m}_f(HV)}$$

Mechanical Efficiency

$$\eta_i = \frac{\dot{W}_b}{\dot{W}_i} = \frac{\eta_b}{\eta_i}$$

Displacement Volume

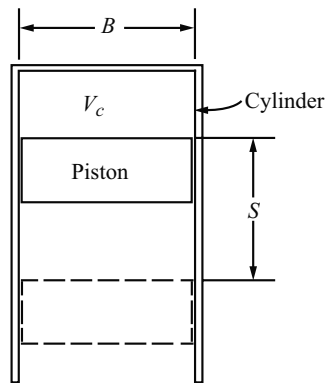

$$V_d = \frac{\pi B^2 S}{4}, \text{ m}^3 \text{ for each cylinder}$$

$$\text{Total volume (m}^3\text{)} = V_t = V_d + V_c$$

$$V_c = \text{clearance volume (m}^3\text{)}$$

Compression Ratio

$$r_c = V_t/V_c$$

Mean Effective Pressure (mep)

$$mep = \frac{\dot{W}n_s}{V_d n_c N}$$

where

n_s = number of crank revolutions per power stroke

n_c = number of cylinders

V_d = displacement volume per cylinder

mep can be based on brake power (*bmep*), indicated power (*imep*), or friction power (*fmep*).

Volumetric Efficiency

$$\eta_v = \frac{2\dot{m}_a}{\rho_a V_d n_c N} \quad (\text{four-stroke cycles only})$$

where

\dot{m}_a = mass flow rate of air into engine (kg/s)

ρ_a = density of air (kg/m³)

Specific Fuel Consumption (SFC)

$$sfc = \frac{\dot{m}_f}{\dot{W}} = \frac{1}{\eta HV}, \text{ kg/J}$$

Use η_b and \dot{W}_b for *bsfc* and η_i and \dot{W}_i for *isfc*.

Gas Turbines

Brayton Cycle (Steady-Flow Cycle)

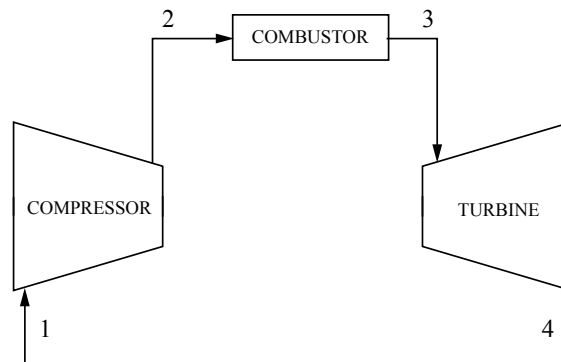

$$w_{12} = h_1 - h_2 = c_p (T_1 - T_2)$$

$$w_{34} = h_3 - h_4 = c_p (T_3 - T_4)$$

$$w_{net} = w_{12} + w_{34}$$

$$q_{23} = h_3 - h_2 = c_p (T_3 - T_2)$$

$$q_{41} = h_1 - h_4 = c_p (T_1 - T_4)$$

$$q_{net} = q_{23} + q_{41}$$

$$\eta = w_{net} / q_{23}$$

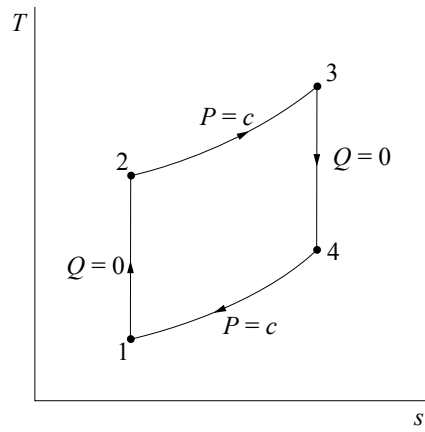
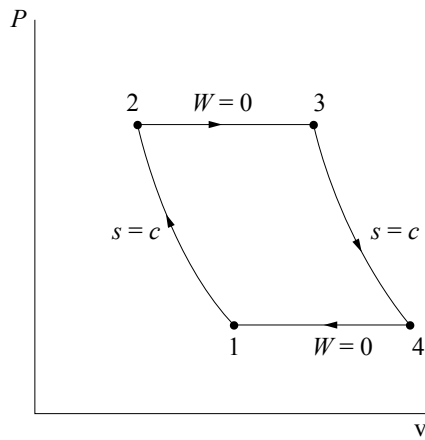

Steam Power Plants

Feedwater Heaters

- *Open (mixing)*

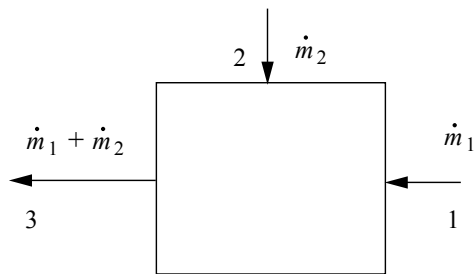

$$\dot{m}_1 h_1 + \dot{m}_2 h_2 = h_3 (\dot{m}_1 + \dot{m}_2)$$

- Closed (no mixing)

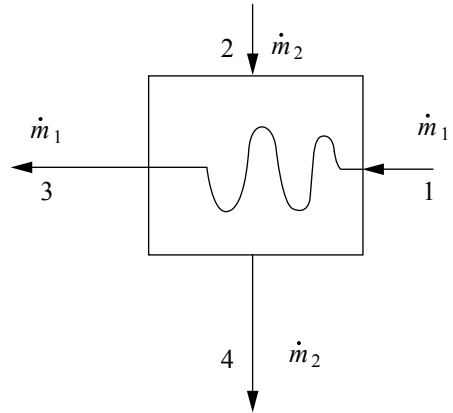

$$\dot{m}_1 h_1 + \dot{m}_2 h_2 = \dot{m}_1 h_3 + \dot{m}_2 h_4$$

Steam Trap

A steam trap removes condensate from steam piping or a heat exchanger.

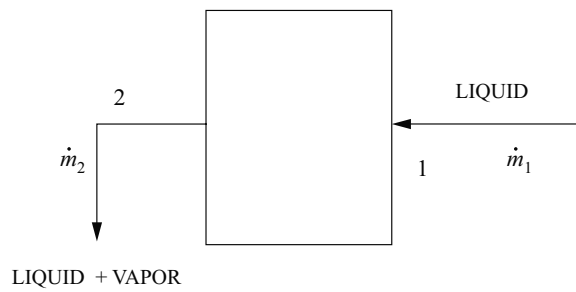

$$h_2 = h_1 \text{ (if adiabatic)}$$

Junction

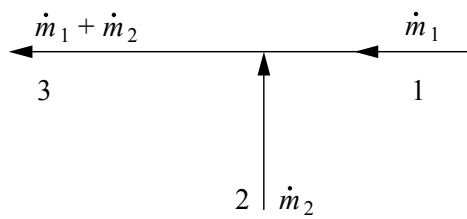

$$\dot{m}_1 h_1 + \dot{m}_2 h_2 = h_3 (\dot{m}_1 + \dot{m}_2)$$

Pump

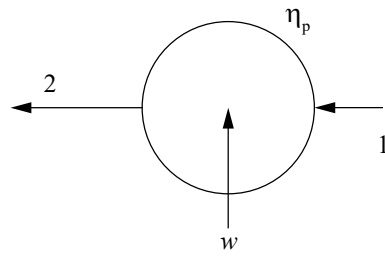

$$w = h_1 - h_2 = (h_1 - h_{2s}) / \eta_p$$

$$h_{2s} - h_1 = v(P_2 - P_1)$$

$$w = \frac{v(P_1 - P_2)}{\eta_p}$$

Index

Symbols

2n factorial design and experiments 421

χ^2 - distribution 68

A

AASHTO 266

absorption (packed columns) 247

ac circuits 359

acids, bases, and pH 86

ac machines 366

ac power 363

activated carbon adsorption 336

activated sludge 332

addition of two matrices 57

aerobic digestion 334

aerodynamics 198

affinity laws 195

airfoil theory 198

air infiltration rates 318

air pollution 310

air refrigeration cycle 174

air stripping 337

alcohols 89

aldehydes 89

algebra of complex numbers 36

algorithm efficiency (Big-O) 412

algorithms 410

allowable stress design 272

amorphous materials 104

amplitude modulation 375

anaerobic digestion 335

analog filter circuits 379

analog-to-digital conversion 225

analysis of variance for 2n factorial designs 421

angle modulation 375

angle of repose 256

angular momentum or moment of momentum 121

anion 92

anode 92

anode reaction (oxidation) of a typical metal, M 94

ANOVA table 71, 72

ANSI symbols for hydraulic power 451

anthropometric measurements 427

approximate solution for solid with sudden convection 207

approximations 83

aqueous solutions 86

Archimedes principle and buoyancy 180

area formulas 308

area moment of inertia 111

arithmetic progression 50

Arrhenius equation 238

ASD 272, 281

ASHRAE Psychrometric Chart No. 1 (English units) 176

ASHRAE Psychrometric Chart No. 1 (metric units) 175

ASME Y14.5 442

associative law 64

ASTM grain size 100

ASTM standard reinforcement bars 276

atmospheric dispersion modeling (Gaussian) 310

atomic bonding 94

atomic number 85

authentication, computer network security 416

automatic request for retransmission (ARQ) 378

available strength in axial compression, W shapes 289

average and range charts 82

average value 359

Avogadro's number 85

B

baghouse 316

balanced three-phase systems 363

bases 86

basic cycles 149

basic freeway segment highway capacity 303

basic heat transfer rate equations 204

Basquin equation 99

batch reactor, constant volume 238

batch reactor, variable volume 240

Bayes' theorem 65

beams 135, 268, 281

beams--flexure 275

beams--shear 276

beam stiffness and moment carryover 268

bearings 432

belt friction 110

bending moment sign conventions 135

benefit-cost analysis 232

Bernoulli equation 181, 182

binary number system 389

binary phase diagrams 105

binomial distribution 66

bioconversion 86

biomass as an energy source 348

biomechanics of the human body 31

biotower 334

bipolar junction transistor (BJT) 386

blowers 194

BOD5 for mixed lagoons in series 331

BOD test solution and seeding procedures 332

boiling 211

boiling point elevation 85

bonds 231

book value 231

breakeven analysis 231

break-through time for leachate to penetrate a clay liner 326

brittle materials 446

bulk (volume) modulus of elasticity 131

bus, network topologies 405

C

cantilevered beam slopes and deflections 141

capacitors and inductors 358

capacitors and inductors in parallel and series 359

- capillary rise 178
capitalized costs 231
carboxylic acids 89
carcinogens 23
Carnot cycle 149, 172
Cartesian coordinates 114
catalyst 85
cathode 92
cathode reactions (reduction) 94
cation 92
cellular biology 93
centrifugal pump characteristics 191
centroids and moments of inertia 50, 112
centroids of masses, areas, lengths, and volumes 108
characteristics of a static liquid 178
characteristics of selected flow configurations 185
chemical compatibility chart 25
chemical reaction engineering 238
chemical reaction equilibria 155
chemical reaction equilibrium 156
chemical sensors 225
chemistry and biology definitions 85
circular pipe head loss equation 297
circular sector 40
circular segment 40
Clapeyron equation 155
clarifier 338
classifiers: wet and dry operations 255
Clausius-Clapeyron equation 155
Clausius' statement of second law 151
closed-system exergy (availability) 152
closed thermodynamic system 147
coagulation equations 341
code of ethics 4
coefficient of performance (COP) 149
columns 137, 281
combinations of random variables 66
combustion 347
combustion processes 153
common mode rejection ratio 381
communication methodologies 407
communication theory and concepts 372
compaction 327
complex power 363
composite materials 101
composite plane wall 206
composite sections 137
compressibility factor 171
compressible flow 189
compressible fluid 195
compressors 193
computer networking 392
computer network security 413
computer systems 408
concentrations of vaporized liquids 29
concept of weight 118
concrete 103
concurrent forces 110
conduction 204
conduction through a cylindrical wall 205
conduction through a plane wall 204
confidence interval for intercept 69
confidence interval for slope 70
confidence interval for the difference between two means μ_1
and μ_2 75
confidence interval for the mean of a normal distribution 74
confidence intervals for the variance of a normal
distribution 75
confidence intervals, sample distributions and sample size 74
confined space safety 20
conic section equation 45
conic sections 43
consequences of fluid flow 183
conservation of angular momentum 125
constant acceleration 117
constant fluid temperature 206
construction 309
continuity equation 181
control network security 413
control systems 226
convection 204, 209, 243
conversion 155
conversion factors 2, 3
convolution 370
copyrights 11
corrosion 94
cost estimation 256
coupling multiplier (CM) 31
CPM precedence relationships 309
creep 99
critical insulation radius 205
critical path method 425
critical stress for compression members 288
critical values of the F distribution 78
critical values of X distribution 79
crystallization processes 256
cumulative binomial probabilities 80
cumulative distribution functions 65
current 356
cycles 173
cycles and processes 455
cyclone 314, 315
cylindrical pressure vessel 131
- D**
Darcy's law 291
Darcy-Weisbach equation 183
data quality objectives (DQO) for sampling soils and
solids 329
data structures 411
dc machines 367
dechlorination of sulfite compounds 332

- decibels and Bode plots 373
 definition of safety 13
 definitions used in ASME Y14.5 442
 deflection of beams 136
 deflectors and blades 188
 delays in computer networks 378
 De Morgan's law 64
 De Morgan's theorems 390
 density 177
 density, specific volume, specific weight, and specific gravity 177
 depletion MOSFETs (low and medium frequency) 387
 depreciation 231
 derivative for differential calculus 45
 derivatives 48
 design column strength, tied columns 278
 design compressive strength 281
 design flexural strength 281
 design of reinforced concrete components (ACI 318-14) 274
 design of steel components (ANSI/AISC 360-16) LRFD, ASD 281
 design shear strength 281
 determinants 58
 deviations for shafts 441
 dew-point temperature 150
 difference equations 60, 369
 differential amplifier 383
 differential calculus 45
 differential equations 51
 Diffie-Hellman key-exchange protocol 416
 diffusion 94, 242
 diffusion coefficient 94
 digital signal processing 371
 dimensional analysis 197
 dimensional homogeneity 197
 diodes 385
 directed graphs, or digraphs, of relation 34
 discrete math 34
 disinfection 345
 dispersion, mean, median, and mode values 63
 distillation 244
 distributive law 64
 Dittus-Boelter equation 211
 dose-response curves 21
 double-sideband modulation 375
 drag coefficient 202
 drag coefficient for spheres, disks, and cylinders 202
 drag force 184
 dual linear program 417
 ductile materials 447
 Dupuit's formula 292
 dynamics 449
 dynamics of mechanisms 435
- E**
 earned-value analysis 309
 earthwork formulas 308
 effective half-life 328
 effective length factor, K 287
 effective or RMS values 360
 effective stack height 312, 313
 effect of overburden pressure 326
 elastic strain energy 138
 electrical and computer engineering 355
 electrical properties of materials 95
 electrical safety 21
 electrical units 355
 electrochemistry 92
 electromagnetic dynamic fields 368
 electrostatic fields 355
 electrostatic precipitator efficiency 317
 electrostatics 355
 elementary statically indeterminate structures by force method of analysis 270
 ellipse 39
 endianness 410
 endurance limit for steels 448
 endurance limit modifying factors 448
 energy 347
 energy equation 181
 energy line (Bernoulli equation) 182
 energy sources and conversion processes 347
 engineering economics 230
 engineering strain 130
 enhancement MOSFET (low and medium frequency) 387
 enthalpy 150
 enthalpy curves 161
 entropy 151
 environmental engineering 310
 equations of state (EOS) 146
 equilibrium constant of a chemical reaction 85
 equilibrium requirements, system of forces 107
 ergonomics 30
 ergonomics: hearing 429
 error coding 377
 essential prime implicant 391
 ethers 89
 ethics 4
 Euler's approximation 62
 Euler's equation 182
 Euler's identity 37
 Euler's or forward rectangular rule 61
 evapotranspiration rates for grasses 291
 exergy (availability) 151
 expected values 65
 exponentially weighted moving average 421
 exposure 27
 external flow 210

F

facility planning 423
 facultative pond 333
 families of organic compounds 90
 fan characteristics 192
 fans, pumps, and compressors 195
 Faraday's law 85
 fate and transport 319
 fatigue 99
 film boiling 213
 film condensation of a pure vapor 214
 filtration equations 340
 finite queue, single server models 419
 finite state machine 34
 fins 209
 fire hydrant: calculating rated capacity 298
 fire hydrant discharging to atmosphere 298
 fire sprinkler discharge 298
 firewalls 413
 first law of thermodynamics 147
 first-order control system model 228
 first-order linear difference equation 60, 370
 first-order linear homogeneous differential equations
 with constant coefficients 51
 first-order linear nonhomogeneous differential
 equations 51
 fits, manufacturability 440
 fixed blade 188
 flammability 19
 flammable gases 20
 flat bars or angles, bolted or welded steel 282
 flat roof snow loads 273
 flip-flops 391
 flow chart definition 413
 flow in closed circuits 201
 flow in noncircular conduits 184
 flow nets 260
 flow reactors, steady state 241
 flow through a packed bed 185
 fluid flow characterization 182
 fluid flow machinery 191
 fluid flow measurement 195
 fluid mechanics 177
 force 107
 forced convection boiling 211
 forced vibration 125, 126
 force method of analysis 270
 forces on submerged surfaces and the center of
 pressure 180
 forecasting 309, 421
 Fourier series 53
 Fourier transform 52
 Fourier transform and its inverse 372
 Fourier transform pairs 55
 Fourier transform theorems 55
 fracture toughness 100

frame deflection by unit load method 269
 free convection boiling 212
 free flow speed 303
 free vibration 125
 freezing point depression 85
 frequency modulation 376
 frequency response and impulse response 372
 Freundlich isotherm 336
 friction 110, 122
 full duplex (Duplex) 407
 fundamental constants 2
 fundamental relationships 418

G

gamma function 68
 gas flux 326
 gauge factor (GF) 222
 Gaussian distribution 67
 Gauss' law 355
 general requirements for licensure 7
 geometric dimensioning and tolerancing (GD&T) 442, 444
 geometric progression 50
 geotechnical 259
 Gibbs free energy 152
 Gibbs phase rule 155
 Globally Harmonized System (GHS) of Classification 15
 Goodman theory, modified 447
 grade line 182
 granular storage and process safety 20
 graph traversal 411
 gravity model 305
 greenhouse gases: global warming potential 353
 Greenshields model 304

H

half-duplex 407
 half-life 328
 hardenability 101
 hazard assessments 14
 Hazen-Williams equation 185, 296
 head loss due to flow 183
 heat 248
 heat exchangers 215
 heats of reaction 152
 heats of reaction, solution, formation, and combustion 85
 heat transfer 204
 heat-transfer rate equations 204
 Helmholtz free energy 152
 Henry's law at constant temperature 153
 highway pavement design 307
 hollow, thin-walled shafts 135
 Hooke's law 134
 horizontal curves 301
 horizontal stress profiles and forces 263
 humid volume 150

HVAC 452
 hydraulic elements graph 294
 hydraulic gradient (grade line) 182
 hydraulic jump 296
 hydraulic residence time 333
 hydrologic mass balance (budget) 290
 hydrology/water resources 290
 hydropower 348
 hypothesis testing 70

I

ICMP type and code values 403
 ICMPv6 type and code values 404
 ideal gas constants 2
 ideal gas mixtures 145
 ideal-impulse sampling 376
 identity matrix 57
 impact 121
 impact test 103
 impulse and momentum 121
 impulse-momentum principle 187
 impulse turbine 189
 incidence variable values 32
 incineration 317
 indefinite integrals 49
 indices 309
 indoor air quality 318
 induced voltage 356
 induction machines 366
 industrial and systems engineering 417
 inflation 231
 influence lines for beams and trusses 268
 instrumental methods of analysis 87
 intake rates 28
 integral calculus 47
 intellectual property 11
 interaction diagram 279, 280
 interaction effects 422
 interest rate tables 233
 intermediate- and long-length columns 443, 446
 internal flow 210
 international tolerance grades 441
 internet control message protocol 403
 internet protocol addressing 394
 internet protocol version 4 header 396
 internet protocol version 6 header 399
 inventory models 423
 inverse transform method 420
 IPv4 special address blocks 395
 IPv6 special address blocks 396
 iron-iron carbide phase diagram 106
 irreversibility 152
 isentropic flow relationships 190

J

jet propulsion 188
 job safety analysis 14

job sequencing 425
 joining methods 436
 junction field effect transistors (JFETs) 387

K

Kelvin-Planck statement of second law 150
 ketones 89
 kiln formula 317
 kinematics, dynamics, and vibrations 449
 kinematics of a rigid body 122
 kinematics of mechanisms 449
 kinetic energy 120, 125
 kinetics of a rigid body 123
 Kirchhoff's laws 357
 Kline-McClintock equation 226

L

lake classification 291
 landfill 325
 Langmuir isotherm 336
 Laplace transforms 56
 lateral-torsional buckling 281
 law of compound or joint probability 65
 laws of probability 64
 learning curves 423
 least squares 69
 Le Chatelier's principle for chemical equilibrium 85
 Le Chatelier's Rule 20
 level of service (LOS) 303
 lever rule 105
 Lewis equation 435
 L'Hospital's Rule 47
 life-cycle analysis 12
 lime-soda softening equations 341
 limiting reactant 155
 limits and fits, manufacturability 439
 limits for longitudinal reinforcements 278
 linear combinations 68
 linear momentum 121
 linear programming 417
 linear regression and goodness of fit 69
 line balancing 425
 live load reduction 272
 load combinations using allowable stress design (ASD) 272
 load combinations using strength design (LRFD) 272
 loads 272
 loads: exposure factor 273
 loads: importance factor 273
 loads: thermal factor 273
 local area network (LAN) 405
 logarithm identities 36
 logarithms 35
 logic operations and Boolean algebra 390
 logit models 305
 lossless transmission lines 369
 LRFD 272, 281

M

Mach number 189
 magnetic fields 356
 Manning's equation 185, 296
 manometers 179
 manufacturability 439
 mass calculations 319
 mass moment of inertia 123
 mass transfer 242
 mass-transfer analogy 248
 material balance 318
 material handling 425
 material properties 138
 materials science/structure of matter 94
 matrices 57
 matrix of relation 34
 matrix properties 58
 matrix transpose 57
 maximum power-transfer theorem 361
 maxterm 391
 McCabe's cyclomatic complexity 416
 mean 63
 mean particle sizes calculated from particle size distributions (PSDs) 253
 measurement 220
 measurement error 68
 measurement uncertainty 69, 226
 mechanical design and analysis 431
 mechanical engineering 431
 mechanical properties of materials 96
 median 63
 member fixed-end moments (magnitudes) 271
 memory/storage types 408
 mensuration of areas and volumes 39
 mesh, network topologies 406
 methanol requirement for biologically treated wastewater 332
 metric prefixes 1
 microbial kinetics 320
 microprocessor architecture 409
 minimum heat flux 213
 minor losses in pipe fittings, contractions, and expansions 183
 minterm 391
 mode 63
 model law 6
 model rules 4
 modified accelerated cost recovery system (MACRS) 231
 Mohr's Circle--Stress, 2D 133
 molality of solutions 85
 molarity of solutions 85
 molar volume of an ideal gas 85
 mole fraction of a substance 85
 Mollier (h, s) diagram for steam 159
 moment of inertia 108
 moment of inertia parallel axis theorem 109

moment of momentum 121
 moments (couples) 107
 momentum depth diagram 295
 Monod kinetics 320
 Moody, Darcy, or Stanton friction factor diagram 201
 moving average 421
 moving blade 189
 moving concentrated load sets 268
 multicore, computer systems 409
 multipath pipeline problems 187
 multiple server model 420
 multiplication of two matrices 57
 municipal solid wastes (MSW) 352

N

national research council (NRC) trickling filter performance 331
 natural (free) convection 214
 Nernst equation 86
 net energy exchange by radiation between two black bodies 218
 net tensile strain 275
 network optimization 417
 network topologies 400, 405
 Newton's method of minimization 61
 Newton's second law for a particle 119
 NIOSH formula 30
 nmap 413
 NOAEL 24
 noise pollution 32
 nomenclature for areas and volumes 39
 non-annual compounding 231
 noncarcinogens 24
 non-constant acceleration 118
 normal and tangential components 116
 normal and tangential kinetics for planar problems 119
 normal distribution (Gaussian distribution) 67
 normality of solutions 85
 normal shock relationships 190
 Norton equivalent 358
 NRCS (SCS) rainfall-runoff 290
 nuclear 349
 nucleate boiling 212
 number systems and codes 389
 numerical integration 61
 numerical methods 60
 numerical solution of ordinary differential equations 62

O

one-dimensional fluid flow 181
 one-dimensional motion of a particle (constant mass) 119
 one-way analysis of variance (ANOVA) 70
 open-channel flow 294
 open-channel flow and/or pipe flow of water 185
 open-system exergy (availability) 152

- open thermodynamic system 147
operational amplifiers 381
orifice discharging freely into atmosphere 186
orifices 196
Otto cycle 172
outdoor air changes per hour 319
overburden pressure 326
oxidation 92
- P**
- pan evaporation 290
parabola 39
parabolic rule 62
paraboloid of revolution 42
parallel 407
parallelogram 41
parallel resonance 362
Parseval's theorem 373
particle curvilinear motion 115
particle kinematics 114
particle kinetics 119
particle rectilinear motion 115
partition coefficients 322
patents 11
peak heat flux 212
peak hour factor (PHF) 299
penetration testing---authorized vulnerability testing 415
people requirements, facility planning 423
percent elongation 130
percent of outdoor air 319
percent reduction in area (RA) 130
performance of components 195
periodic table of elements 88
permissible noise exposure 33
permutations and combinations 64
PERT 426
pH 86
phase relations 155
phasor transforms of sinusoids 360
P-h diagrams 160, 161, 165
phosphorus removal equations 342
photoelectric effect 95
photosynthesis 87
pH sensors 224
pictograms, GHS 15, 17, 18
piezoelectric effect 95, 222
piezoresistive effect 222
pin fin 209
pipe bends, enlargements, and contractions 187
pipe flow of water 185
pipeline type 409
piping segment slopes and deflections 142
pitot tube 195
plane circular motion 116
plane frame 271
plane motion of a rigid body 122
plane truss 271
plane truss: method of joints 110
plane truss: method of sections 110
plant location 424
pointers 410
polar coordinate system 36
polymer additives 104
polymers 104
pool boiling 211
population modeling 327
population projection equations 327
port scanning 415
possible cathode reactions (reduction) 94
potential energy 120
pound-force 1
pound-mass 1
power absorbed by a resistive element 357
power and efficiency 120
power conversion 384
power screws 433
power series 50
power transmission 433
pressure 177
pressure curves 161
pressure drop for laminar flow 184
pressure field in a static liquid 178
pressure sensors 224
pressure versus enthalpy curves for Refrigerant 134a 161
pressure versus enthalpy curves for Refrigerant 410A 165
primary bonds 94
prime implicant 391
principal stresses 132
principle of angular impulse and momentum 125
principle of work and energy 119
principles of one-dimensional fluid flow 181
prismoid 41
probability and density functions: means and variances 84
probability density function 65
probability functions, distributions, and expected values 65
process capability 418
product of inertia 109, 111
professional practice 4
progressions and series 50
projectile motion 118
propagation of error 68
properties for two-phase (vapor-liquid) systems 144
properties of air 311
properties of liquid 166
properties of materials 95
properties of materials: electrical 95
properties of materials: mechanical 96
properties of metals 97
properties of saturated liquid and saturated vapor 162
properties of series 50
properties of single-component systems 143
properties of water 199, 200
protocol definitions 393
psychrometric charts 175

psychrometrics 150
 pulse-amplitude modulation--natural sampling 377
 pulse-code modulation 377
 pump power equation 192
 PVT behavior 144

Q

quadratic equation 35
 quadric surface (sphere) 35
 queueing models 418

R

radial and transverse components for planar motion 114
 radiation 204, 217, 328
 radiation: types of bodies 217
 radius of gyration 109
 rainfall 290
 randomized complete block design 70
 random variate generation 420
 Rankine cycle 172
 Raoult's law for vapor-liquid equilibrium 153
 rapid mix and flocculator design 343
 rate-of-return 231
 rate of transfer as a function of gradients at the wall 249
 rational formula 290
 RC and RL transients 362
 real gas 146
 recommended weight limit (RWL) 30
 rectangular fin 209
 reduction, electrochemistry 92
 reference dose (RfD) 24
 Refrigerant 134a (1,1,1,2-Tetrafluoroethane) properties
 of saturated liquid and saturated vapor 162
 Refrigerant 410A [R-32/125 (50/50)] properties of liquid
 on bubble line and vapor on dew line 166
 refrigeration and HVAC 173
 refrigeration cycle 172
 regular polygon 41
 reinforced concrete beams 275
 relationship between hardness and tensile strength 100
 relative humidity 150
 relative motion 115
 reliability 422
 removal and inactivation requirements 345
 removal credits and inactivation requirements for
 various treatment technologies 346
 representative values of fracture toughness 100
 residual 69
 resistance factors 275
 resistance temperature detector (RTD) 220
 resistivity 356
 resistors in series and parallel 357
 resolution of a force 107
 resonance 362
 resultant force (two dimensions) 107
 retaining walls 264
 reversed Carnot cycle 172

reverse osmosis 344
 Reynolds number 182
 right circular cone 42
 right circular cylinder 42
 rigid body motion about a fixed axis 124
 rigorous vapor-liquid equilibrium 154
 risk 231
 risk assessment/toxicology 21
 RMS values 360
 roots 37
 rotating machines 365
 RSA public-key cryptosystem 416
 runoff 290

S

safety 13
 safety and prevention 13
 safety data sheet (SDS) 18
 sample correlation coefficient and coefficient of
 determination 70
 sampled messages 376
 sample size 75
 sampling 225
 sampling and monitoring 329
 saturated boiling 211
 scaling laws; affinity laws 195
 screw thread 110
 SCS rainfall-runoff 290
 second law of thermodynamics 150
 second-order control system models 228
 second-order linear difference equation 370
 second-order linear homogeneous differential equations with
 constant coefficients 52
 security triad 416
 selected properties of air 311
 selected rules of nomenclature in organic chemistry 89
 selectivity, chemical reaction equilibria 155
 semiconductors 98
 serial, communications methodologies 407
 series resonance 362
 servomotors and generators 368
 settling equations 339
 Shannon channel capacity formula 379
 shape factor (view factor, configuration factor) relations 217
 shear 281
 shearing force and bending moment sign conventions 135
 shear stress-strain 130
 short columns 278
 Sieder-Tate equation 211
 sieve conversion table 252
 signal conditioning 226
 signal words 19
 significant figures 2
 similitude 197
 simplex, communication methodologies 407
 simply supported beam slopes and deflections 140
 Simpson's Rule/Parabolic Rule 62

- simulation 420
 sine-cosine relations and trigonometric identities 360
 single server models 419
 single-sideband modulation 375
 singly-reinforced beams 275
 slope failure along planar surface 265
 societal considerations 12
 Soderberg theory 447
 software engineering 410
 software process flows 412
 software syntax guidelines 412
 software testing 413
 soil classification 265, 266
 soil landfill cover water balance 326
 solar 351
 solids handling 250
 solids processing 253
 solid-state electronics and devices 382
 solid with sudden convection 207
 solubility product 85
 sorption zone 336
 source equivalents 357
 specific energy diagram 295
 specific gravity 177
 specific gravity for a solids slurry 331
 specific humidity 150
 specific volume 177
 specific weight 177
 sphere 40
 spherical particles 203
 springs 431
 sprinkler K factors 298
 stability, determinacy, and classification of structures 271
 standard deviation charts 82
 standard error of estimate 69
 standard time determination 424
 star, network topologies 406
 state functions (properties) 143
 statically determinate truss 110
 static liquid 178
 static loading failure theories 446
 statics 107
 statistical quality control 82
 steady-flow systems 148
 steam tables 157
 steel beams 281
 steel columns 281
 steel tension members 282
 Steinhart-Hart equation 221
 Stokes' law 339
 stopping sight distance 299
 storativity 291
 straight line 35
 strain gauge 222
 strength design 272
 stress 99, 177
 stress and strain 132
 stresses in beams 136
 stress, pressure, and viscosity 177
 stress-strain curve for mild steel 130
 structural analysis 268
 structural design 272
 student's t-distribution 77
 sub-cooled boiling 211
 submerged orifice operating under steady-flow conditions 186
 sum of squares of random error 422
 superheated water tables 158
 surface tension and capillarity 178
 surface water system hydrologic budget 290
 sustainability 354
 sweep-through concentration change in a vessel 29
 switching function terminology 391
 synchronous machines 366
 system performance studies 227
 systems of forces 107
- T**
 taxation 231
 Taylor's series 51
 Taylor tool life formula 426
 t-distribution 68
 temperature conversion 1
 temperature sensors 220
 tension members 282
 terminal settling velocity 339
 terminal velocities 203
 tests for out of control 83
 tests on means of normal distribution---variance known 73
 tests on means of normal distribution---variance unknown 73
 tests on variances of normal distribution with unknown
 mean 74
 test statistics 75
 Theim equation 293
 thermal and mechanical processing 94
 thermal and physical property tables 169
 thermal deformations 131
 thermal properties 104
 thermal resistance (R) 205
 thermistors 221
 thermocouple (TC) 221
 Thévenin equivalent 357
 threading, computer systems 409
 three-phase transformer connection diagrams 365
 threshold limit value (TLV) 23
 thyristor or silicon controlled rectifier (SCR) 385
 torsion 134
 torsional strain 134
 torsional vibration 127
 toxicity 19, 22, 23
 toxicology 21
 trademarks 11
 trade secrets 12
 traffic flow relationships 304
 traffic safety equations 306

traffic signal timing 299
 transducer 220
 transformers 364
 transient conduction using the lumped capacitance model 206
 transition boiling 213
 transmission algorithms 378
 transmission control protocol 400
 transmissivity 291
 transportation 299
 transport phenomena--momentum, heat, and mass-transfer analogy 248
 trapezoidal rule 61
 tree, network topologies 406
 tree traversal 411
 trigonometric identities 360
 trigonometry 37
 trigonometry identities 38
 truss deflection by unit load method 268
 turbines 194
 turns ratio 364
 two-factor factorial designs 71
 two first-order irreversible reactions in series 241
 two irreversible reactions in parallel 241
 two-port parameters 368
 two-stage cycle 173

U

ultimate bearing capacity 264
 ultrafiltration 345
 uniaxial loading and deformation 131
 uniaxial stress-strain 130
 unified design provisions 277
 Unified Soil Classification System 267
 unit hydrograph 291
 unit normal distribution 76
 units in FE exam 1
 unsaturated acyclic hydrocarbons 89
 user datagram protocol 402

V

Vadose zone penetration 323
 vaporized liquids 29
 vapor-liquid equilibrium (VLE) 153, 246
 variable loading failure theories 447
 variances 309
 vectors 59
 vectors: gradient, divergence, and curl 59
 vectors: identities 60
 velocity pressure exposure coefficient 274
 Venturi meters 196
 vertical curve formulas 308
 vertical curves 300
 vertical stress profiles 264
 vertical stress profiles with surcharge 264
 vibrations 449
 viscosity 177

voltage 356
 voltage regulation 368
 volume flow rate of outdoor air 318

W

wastes with fuel value 352
 wastewater treatment and technologies 331
 water resources 290
 water treatment technologies 336
 web vulnerability testing 415
 weir formulas 296
 well drawdown 292
 wet-bulb temperature 150
 wet solids 251
 Wheatstone bridge 224
 wind 349
 wind loads 274
 wind turbines 350
 work 120
 work sampling formulas 426
 W shapes available moment vs. unbraced length 286
 W shapes dimensions and properties 284

X**Y**

yield 155
 yielding 281

Z

z-transforms 370

Appendix: FE Exam Specifications

Chemical.....472

Civil.....476

Electrical and Computer479

Environmental.....482

Industrial and Systems485

Mechanical.....488

Other Disciplines492

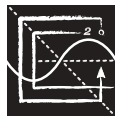

Fundamentals of Engineering (FE) CHEMICAL CBT Exam Specifications

Effective Beginning with the July 2020 Examinations

- The FE exam is a computer-based test (CBT). It is closed book with an electronic reference.
- Examinees have 6 hours to complete the exam, which contains 110 questions. The 6-hour time also includes a tutorial and an optional scheduled break.
- The FE exam uses both the International System of Units (SI) and the U.S. Customary System (USCS).

Knowledge	Number of Questions
1. Mathematics	6–9
A. Analytic geometry, logarithms, and trigonometry	
B. Calculus (e.g., single-variable, integral, differential)	
C. Differential equations (e.g., ordinary, partial, Laplace)	
D. Numerical methods (e.g., error propagation, Taylor's series, curve fitting, Newton-Raphson, Fourier series)	
E. Algebra (e.g., fundamentals, matrix algebra, systems of equations)	
F. Accuracy, precision, and significant figures	
2. Probability and Statistics	4–6
A. Probability distributions (e.g., discrete, continuous, normal, binomial)	
B. Expected value (weighted average) in decision making	
C. Hypothesis testing and design of experiments (e.g., t-test, outlier testing, analysis of the variance)	
D. Measures of central tendencies and dispersions (e.g., mean, mode, standard deviation, confidence intervals)	
E. Regression and curve fitting	
F. Statistical control (e.g., control limits)	
3. Engineering Sciences	4–6
A. Basic dynamics (e.g., friction, force, mass, acceleration, momentum)	
B. Work, energy, and power (as applied to particles or rigid bodies)	
C. Electricity, current, and voltage laws (e.g., charge, energy, current, voltage, power, Kirchhoff's law, Ohm's law)	
4. Materials Science	4–6
A. Chemical, electrical, mechanical, and physical properties (e.g., effect of temperature, pressure, stress, strain, failure)	
B. Material types and compatibilities (e.g., engineered materials, ferrous and nonferrous metals)	
C. Corrosion mechanisms and control	
D. Polymers, ceramics, and composites	

- 5. Chemistry and Biology** **7–11**
- A. Inorganic chemistry (e.g., molarity, normality, molality, acids, bases, redox reactions, valence, solubility product, pH, pK, electrochemistry, periodic table)
 - B. Organic chemistry (e.g., nomenclature, structure, balanced equations, reactions, synthesis)
 - C. Analytical chemistry (e.g., wet chemistry and instrumental chemistry)
 - D. Biochemistry, microbiology, and molecular biology (e.g., organization and function of the cell; Krebs, glycolysis, Calvin cycles; enzymes and protein chemistry; genetics; protein synthesis, translation, transcription)
 - E. Bioprocessing (e.g., fermentation, biological treatment systems, aerobic, anaerobic process, nutrient removal)
- 6. Fluid Mechanics/Dynamics** **8–12**
- A. Fluid properties
 - B. Dimensionless numbers (e.g., Reynolds number)
 - C. Mechanical energy balance (e.g., pipes, valves, fittings, pressure losses across packed beds, pipe networks)
 - D. Bernoulli equation (hydrostatic pressure, velocity head)
 - E. Laminar and turbulent flow
 - F. Flow measurement (e.g., orifices, Venturi meters)
 - G. Pumps, turbines, compressors, and vacuum systems
 - H. Compressible flow and non-Newtonian fluids
- 7. Thermodynamics** **8–12**
- A. Thermodynamic properties of pure components and mixtures (e.g., specific volume, internal energy, enthalpy, entropy, free energy, ideal gas law)
 - B. Properties data and phase diagrams of pure components and mixtures (e.g., steam tables, psychrometric charts, T-s, P-h, x-y, T-x-y)
 - C. Thermodynamic laws (e.g., first law, second law)
 - D. Thermodynamic processes (e.g., isothermal, adiabatic, isentropic, phase changes)
 - E. Cyclic processes and efficiencies (e.g., power, refrigeration, heat pump)
 - F. Phase equilibrium (e.g., fugacity, activity coefficient, Raoult's law)
 - G. Chemical equilibrium
 - H. Heats of reaction and mixing
- 8. Material/Energy Balances** **10–15**
- A. Steady-state mass balance
 - B. Unsteady-state mass balance
 - C. Steady-state energy balance
 - D. Unsteady-state energy balance
 - E. Recycle/bypass processes
 - F. Reactive systems (e.g., combustion)

- 9. Heat Transfer** **8–12**
- A. Conductive heat transfer
 - B. Convective heat transfer (natural and forced)
 - C. Radiation heat transfer
 - D. Heat-transfer coefficients (e.g., overall, local, fouling)
 - E. Heat-transfer equipment, operation, and design (e.g., double pipe, shell and tube, fouling, number of transfer units, log-mean temperature difference, flow configuration)
- 10. Mass Transfer and Separation** **8–12**
- A. Molecular diffusion (e.g., steady and unsteady state, physical property estimation)
 - B. Convective mass transfer (e.g., mass-transfer coefficient, eddy diffusion)
 - C. Separation systems (e.g., distillation, absorption, extraction, membrane processes, adsorption)
 - D. Equilibrium stage methods (e.g., graphical methods, McCabe-Thiele, efficiency)
 - E. Continuous contact methods (e.g., number of transfer units, height equivalent to a theoretical plate, height of transfer unit, number of theoretical plates)
 - F. Humidification, drying, and evaporation
- 11. Solids Handling** **3–5**
- A. Particle properties (e.g., surface and bulk forces, particle size distribution)
 - B. Processing (e.g., crushing, grinding, crystallization)
 - C. Transportation and storage (e.g., belts, pneumatic, slurries, tanks, hoppers)
- 12. Chemical Reaction Engineering** **7–11**
- A. Reaction rates and order
 - B. Rate constant (e.g., Arrhenius function)
 - C. Conversion, yield, and selectivity
 - D. Type of reactions (e.g., series, parallel, forward, reverse, homogeneous, heterogeneous, biological)
 - E. Reactor types (e.g., batch, semibatch, continuous stirred tank, plug flow, gas phase, liquid phase)
 - F. Catalysis (e.g., mechanisms, biocatalysis, physical properties)
- 13. Economics** **4–6**
- A. Time value of money (e.g., present worth, annual worth, future worth, rate of return)
 - B. Economic analyses (e.g., breakeven, benefit-cost, optimal economic life)
 - C. Uncertainty (e.g., expected value and risk)
 - D. Project selection (e.g., comparison of projects with unequal lives, lease/buy/make, depreciation, discounted cash flow)

- 14. Process Design** **7–11**
- A. Process flow diagrams and piping and instrumentation diagrams
 - B. Equipment selection (e.g., sizing and scale-up)
 - C. Equipment and facilities cost estimation (e.g., cost indices, equipment costing)
 - D. Process design and optimization (e.g., sustainability, efficiency, green engineering, inherently safer design, evaluation of specifications, product design)
 - E. Design standards (e.g., regulatory, ASTM, ISO, OSHA)
- 15. Process Control** **4–6**
- A. Dynamics (e.g., first- and second-order processes, gains and time constants, stability, damping, and transfer functions)
 - B. Control strategies (e.g., feedback, feedforward, cascade, ratio, PID controller tuning, alarms, other safety equipment)
 - C. Control loop design and hardware (e.g., matching measured and manipulated variables, sensors, control valves, conceptual process control, distributed control system [DCS] programming, programmable logic controller [PLC] programming, interlocks)
- 16. Safety, Health, and Environment** **5–8**
- A. Hazardous properties of materials, including SDS (e.g., corrosivity, flammability, toxicity, reactivity, handling, storage, transportation)
 - B. Industrial hygiene (e.g., toxicity, noise, PPE, ergonomics)
 - C. Process safety, risk assessment, and hazard analysis (e.g., layer of protection analysis, hazard and operability [HAZOP] studies, fault and event tree analysis, dispersion modeling)
 - D. Overpressure and underpressure protection (e.g., relief, redundant control, inherently safe)
 - E. Waste minimization, waste treatment, and regulation (e.g., air, water, solids, RCRA, CWA, other EPA, OSHA)
 - F. Reactivity hazards (e.g., inerting, runaway reactions, compatibility)
- 17. Ethics and Professional Practice** **3–5**
- A. Codes of ethics (professional and technical societies)
 - B. Agreements, contracts, and contract law (e.g., noncompete, nondisclosure, memorandum of understanding)
 - C. Public health, safety, and welfare (e.g., public protection issues, licensing, professional liability, regulatory issues)
 - D. Intellectual property (e.g., copyright, trade secrets, patents, trademarks)

**Fundamentals of Engineering (FE)
CIVIL CBT Exam Specifications**

Effective Beginning with the July 2020 Examinations

- The FE exam is a computer-based test (CBT). It is closed book with an electronic reference.
- Examinees have 6 hours to complete the exam, which contains 110 questions. The 6-hour time also includes a tutorial and an optional scheduled break.
- The FE exam uses both the International System of Units (SI) and the U.S. Customary System (USCS).

Knowledge	Number of Questions
1. Mathematics and Statistics	8–12
A. Analytic geometry	
B. Single-variable calculus	
C. Vector operations	
D. Statistics (e.g., distributions, mean, mode, standard deviation, confidence interval, regression and curve fitting)	
2. Ethics and Professional Practice	4–6
A. Codes of ethics (professional and technical societies)	
B. Professional liability	
C. Licensure	
D. Contracts and contract law	
3. Engineering Economics	5–8
A. Time value of money (e.g., equivalence, present worth, equivalent annual worth, future worth, rate of return)	
B. Cost (e.g., fixed, variable, direct and indirect labor, incremental, average, sunk)	
C. Analyses (e.g., breakeven, benefit-cost, life cycle, sustainability, renewable energy)	
D. Uncertainty (e.g., expected value and risk)	
4. Statics	8–12
A. Resultants of force systems	
B. Equivalent force systems	
C. Equilibrium of rigid bodies	
D. Frames and trusses	
E. Centroid of area	
F. Area moments of inertia	
G. Static friction	

5. Dynamics	4–6
A. Kinematics (e.g., particles, rigid bodies)	
B. Mass moments of inertia	
C. Force acceleration (e.g., particles, rigid bodies)	
D. Work, energy, and power (e.g., particles, rigid bodies)	
6. Mechanics of Materials	7–11
A. Shear and moment diagrams	
B. Stresses and strains (e.g., diagrams, axial, torsion, bending, shear, thermal)	
C. Deformations (e.g., axial, torsion, bending, thermal)	
D. Combined stresses, principal stresses, and Mohr's circle	
E. Elastic and plastic deformations	
7. Materials	5–8
A. Mix design of concrete and asphalt	
B. Test methods and specifications of metals, concrete, aggregates, asphalt, and wood	
C. Physical and mechanical properties of metals, concrete, aggregates, asphalt, and wood	
8. Fluid Mechanics	6–9
A. Flow measurement	
B. Fluid properties	
C. Fluid statics	
D. Energy, impulse, and momentum of fluids	
9. Surveying	6–9
A. Angles, distances, and trigonometry	
B. Area computations	
C. Earthwork and volume computations	
D. Coordinate systems (e.g., state plane, latitude/longitude)	
E. Leveling (e.g., differential, elevations, percent grades)	
10. Water Resources and Environmental Engineering	10–15
A. Basic hydrology (e.g., infiltration, rainfall, runoff, watersheds)	
B. Basic hydraulics (e.g., Manning equation, Bernoulli theorem, open-channel flow)	
C. Pumps	
D. Water distribution systems	
E. Flood control (e.g., dams, routing, spillways)	
F. Stormwater (e.g., detention, routing, quality)	
G. Collection systems (e.g., wastewater, stormwater)	
H. Groundwater (e.g., flow, wells, drawdown)	
I. Water quality (e.g., ground and surface, basic water chemistry)	
J. Testing and standards (e.g., water, wastewater, air, noise)	
K. Water and wastewater treatment (e.g., biological processes, softening, drinking water treatment)	

- 11. Structural Engineering** **10–15**
- A. Analysis of statically determinant beams, columns, trusses, and frames
 - B. Deflection of statically determinant beams, trusses, and frames
 - C. Column analysis (e.g., buckling, boundary conditions)
 - D. Structural determinacy and stability analysis of beams, trusses, and frames
 - E. Elementary statically indeterminate structures
 - F. Loads, load combinations, and load paths (e.g., dead, live, lateral, influence lines and moving loads, tributary areas)
 - G. Design of steel components (e.g., codes and design philosophies, beams, columns, tension members, connections)
 - H. Design of reinforced concrete components (e.g., codes and design philosophies, beams, columns)
- 12. Geotechnical Engineering** **10–15**
- A. Index properties and soil classifications
 - B. Phase relations
 - C. Laboratory and field tests
 - D. Effective stress
 - E. Stability of retaining structures (e.g., active/passive/at-rest pressure)
 - F. Shear strength
 - G. Bearing capacity
 - H. Foundation types (e.g., spread footings, deep foundations, wall footings, mats)
 - I. Consolidation and differential settlement
 - J. Slope stability (e.g., fills, embankments, cuts, dams)
 - K. Soil stabilization (e.g., chemical additives, geosynthetics)
- 13. Transportation Engineering** **9–14**
- A. Geometric design (e.g., streets, highways, intersections)
 - B. Pavement system design (e.g., thickness, subgrade, drainage, rehabilitation)
 - C. Traffic capacity and flow theory
 - D. Traffic control devices
 - E. Transportation planning (e.g., travel forecast modeling, safety, trip generation)
- 14. Construction Engineering** **8–12**
- A. Project administration (e.g., documents, management, procurement, project delivery methods)
 - B. Construction operations and methods (e.g., safety, equipment, productivity analysis, temporary erosion control)
 - C. Project controls (e.g., earned value, scheduling, allocation of resources, activity relationships)
 - D. Construction estimating
 - E. Interpretation of engineering drawings

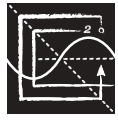

Fundamentals of Engineering (FE) ELECTRICAL AND COMPUTER CBT Exam Specifications

Effective Beginning with the July 2020 Examinations

- The FE exam is a computer-based test (CBT). It is closed book with an electronic reference.
- Examinees have 6 hours to complete the exam, which contains 110 questions. The 6-hour time also includes a tutorial and an optional scheduled break.
- The FE exam uses both the International System of Units (SI) and the U.S. Customary System (USCS).

Knowledge	Number of Questions
1. Mathematics	11–17
A. Algebra and trigonometry	
B. Complex numbers	
C. Discrete mathematics	
D. Analytic geometry	
E. Calculus (e.g., differential, integral, single-variable, multivariable)	
F. Ordinary differential equations	
G. Linear algebra	
H. Vector analysis	
2. Probability and Statistics	4–6
A. Measures of central tendencies and dispersions (e.g., mean, mode, standard deviation)	
B. Probability distributions (e.g., discrete, continuous, normal, binomial, conditional probability)	
C. Expected value (weighted average)	
3. Ethics and Professional Practice	4–6
A. Codes of ethics (e.g., professional and technical societies, NCEES <i>Model Law</i> and <i>Model Rules</i>)	
B. Intellectual property (e.g., copyright, trade secrets, patents, trademarks)	
C. Safety (e.g., grounding, material safety data, PPE, radiation protection)	
4. Engineering Economics	5–8
A. Time value of money (e.g., present value, future value, annuities)	
B. Cost estimation	
C. Risk identification	
D. Analysis (e.g., cost-benefit, trade-off, breakeven)	

5. Properties of Electrical Materials	4–6
A. Semiconductor materials (e.g., tunneling, diffusion/drift current, energy bands, doping bands, p-n theory)	
B. Electrical (e.g., conductivity, resistivity, permittivity, magnetic permeability, noise)	
C. Thermal (e.g., conductivity, expansion)	
6. Circuit Analysis (DC and AC Steady State)	11–17
A. KCL, KVL	
B. Series/parallel equivalent circuits	
C. Thevenin and Norton theorems	
D. Node and loop analysis	
E. Waveform analysis (e.g., RMS, average, frequency, phase, wavelength)	
F. Phasors	
G. Impedance	
7. Linear Systems	5–8
A. Frequency/transient response	
B. Resonance	
C. Laplace transforms	
D. Transfer functions	
8. Signal Processing	5–8
A. Sampling (e.g., aliasing, Nyquist theorem)	
B. Analog filters	
C. Digital filters (e.g., difference equations, Z-transforms)	
9. Electronics	7–11
A. Models, biasing, and performance of discrete devices (e.g., diodes, transistors, thyristors)	
B. Amplifiers (e.g., single-stage/common emitter, differential, biasing)	
C. Operational amplifiers (e.g., ideal, nonideal)	
D. Instrumentation (e.g., measurements, data acquisition, transducers)	
E. Power electronics (e.g., rectifiers, inverters, converters)	
10. Power Systems	8–12
A. Power theory (e.g., power factor, single and three phase, voltage regulation)	
B. Transmission and distribution (e.g., real and reactive losses, efficiency, voltage drop, delta and wye connections)	
C. Transformers (e.g., single-phase and three-phase connections, reflected impedance)	
D. Motors and generators (e.g., synchronous, induction, dc)	
11. Electromagnetics	4–6
A. Electrostatics/magnetostatics (e.g., spatial relationships, vector analysis)	
B. Electrodynamics (e.g., Maxwell equations, wave propagation)	
C. Transmission lines (high frequency)	

12. Control Systems	6–9
<ul style="list-style-type: none"> A. Block diagrams (e.g. feedforward, feedback) B. Bode plots C. Closed-loop response, open-loop response, and stability D. Controller performance (e.g., steady-state errors, settling time, overshoot) 	
13. Communications	5–8
<ul style="list-style-type: none"> A. Basic modulation/demodulation concepts (e.g., AM, FM, PCM) B. Fourier transforms/Fourier series C. Multiplexing (e.g., time division, frequency division, code division) D. Digital communications 	
14. Computer Networks	4–6
<ul style="list-style-type: none"> A. Routing and switching B. Network topologies (e.g., mesh, ring, star) C. Network types (e.g., LAN, WAN, internet) D. Network models (e.g., OSI, TCP/IP) E. Network intrusion detection and prevention (e.g., firewalls, endpoint detection, network detection) F. Security (e.g., port scanning, network vulnerability testing, web vulnerability testing, penetration testing, security triad) 	
15. Digital Systems	8–12
<ul style="list-style-type: none"> A. Number systems B. Boolean logic C. Logic gates and circuits D. Logic minimization (e.g., SOP, POS, Karnaugh maps) E. Flip-flops and counters F. Programmable logic devices and gate arrays G. State machine design H. Timing (e.g., diagrams, asynchronous inputs, race conditions and other hazards) 	
16. Computer Systems	5–8
<ul style="list-style-type: none"> A. Microprocessors B. Memory technology and systems C. Interfacing 	
17. Software Engineering	4–6
<ul style="list-style-type: none"> A. Algorithms (e.g., sorting, searching, complexity, big-O) B. Data structures (e.g., lists, trees, vectors, structures, arrays) C. Software implementation (e.g., iteration, conditionals, recursion, control flow, scripting, testing) 	

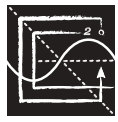

Fundamentals of Engineering (FE) ENVIRONMENTAL CBT Exam Specifications Effective Beginning with the July 2020 Examinations

- The FE exam is a computer-based test (CBT). It is closed book with an electronic reference.
- Examinees have 6 hours to complete the exam, which contains 110 questions. The 6-hour time also includes a tutorial and an optional scheduled break.
- The FE exam uses both the International System of Units (SI) and the U.S. Customary System (USCS).

Knowledge	Number of Questions
1. Mathematics	5–8
A. Analytic geometry and trigonometry	
B. Algebraic equations and roots	
C. Calculus (e.g., differential, integral, differential equations)	
D. Numerical methods (e.g., numerical integration, approximations, precision limits, error propagation)	
2. Probability and Statistics	4–6
A. Measures of central tendencies and dispersions (e.g., mean, mode, standard deviation)	
B. Probability distributions (e.g., discrete, continuous, normal, binomial)	
C. Estimation for a single mean (e.g., point, confidence intervals)	
D. Regression (linear, multiple), curve fitting, and goodness of fit (e.g., correlation coefficient, least squares)	
E. Hypothesis testing (e.g., t-test, outlier testing, analysis of the variance)	
3. Ethics and Professional Practice	5–8
A. Codes of ethics (e.g., professional and technical societies, ethical and legal considerations)	
B. Public health, safety, and welfare (e.g., public protection issues, licensing boards, professional liability)	
C. Compliance with codes, standards, and regulations (e.g., CWA, CAA, RCRA, CERCLA, SDWA, NEPA, OSHA)	
D. Engineer's role in society (e.g., sustainability, resiliency, long-term viability)	
4. Engineering Economics	5–8
A. Time value of money (e.g., equivalence, present worth, equivalent annual worth, future worth, rate of return, annuities)	
B. Cost types and breakdowns (e.g., fixed, variable, direct and indirect labor, incremental, average, sunk, O&M)	
C. Economic analyses (e.g., benefit-cost, breakeven, minimum cost, overhead, life cycle)	
D. Project selection (e.g., comparison of projects with unequal lives, lease/buy/make, depreciation, discounted cash flow)	

5. Fundamental Principles	7–11
A. Population projections and demand calculations (e.g., water, wastewater, solid waste, energy)	
B. Reactors	
C. Materials science (e.g., properties, corrosion, compatibility, stress strain)	
6. Environmental Chemistry	7–11
A. Stoichiometry and chemical reactions (e.g., equilibrium, acid-base, oxidation-reduction, precipitation, pC-pH)	
B. Kinetics (e.g., chemical conversion, growth and decay)	
C. Organic chemistry (e.g., nomenclature, functional group reactions)	
D. Multimedia equilibrium partitioning (e.g., Henry's law, octanol partitioning coefficient)	
7. Health Hazards and Risk Assessment	4–6
A. Dose-response toxicity (e.g., carcinogen, noncarcinogen)	
B. Exposure routes and pathways	
C. Occupational health (e.g., PPE, noise pollution, safety screening)	
8. Fluid Mechanics and Hydraulics	12–18
A. Fluid statics (e.g., pressure, force analysis)	
B. Closed conduits (e.g., Darcy-Weisbach, Hazen-Williams, Moody)	
C. Open channel (e.g., Manning, supercritical/subcritical, culverts, hydraulic elements)	
D. Pumps (e.g., power, operating point, parallel, series)	
E. Flow measurement (e.g., weirs, orifices, flumes)	
F. Blowers (e.g., power, inlet/outlet pressure, efficiency, operating point, parallel, series)	
G. Fluid dynamics (e.g., Bernoulli, laminar flow, turbulent flow, continuity equation)	
H. Steady and unsteady flow	
9. Thermodynamics	3–5
A. Thermodynamic laws (e.g., first law, second law)	
B. Energy, heat, and work (e.g., efficiencies, coefficient of performance, energy cycles, energy conversion, conduction, convection, radiation)	
C. Behavior of ideal gases	
10. Surface Water Resources and Hydrology	9–14
A. Runoff calculations (e.g., land use, land cover, time of concentration, duration, intensity, frequency, runoff control, runoff management)	
B. Water storage sizing (e.g., reservoir, detention and retention basins)	
C. Routing (e.g., channel, reservoir)	
D. Water quality and modeling (e.g., erosion, channel stability, stormwater quality management, wetlands, Streeter-Phelps, eutrophication)	
E. Water budget (e.g., evapotranspiration, precipitation, infiltration, soil moisture, storage)	

- 11. Groundwater, Soils, and Sediments** **8–12**
- A. Basic hydrogeology (e.g., aquifer properties, soil characteristics, subsurface)
 - B. Groundwater flow (e.g., Darcy’s law, specific capacity, velocity, gradient, transport mechanisms)
 - C. Drawdown (e.g., Dupuit, Jacob, Theis, Thiem)
 - D. Remediation of soil, sediment, and/or groundwater (e.g., recovery, ex-situ/in-situ treatment)
- 12. Water and Wastewater** **12–18**
- A. Water and wastewater characteristics (e.g., physical, chemical, biological, nutrients)
 - B. Mass balance and loading rates (e.g., removal efficiencies)
 - C. Physical processes (e.g., sedimentation/clarification, filtration, adsorption, membrane, flocculation, headworks, flow equalization, air stripping, activated carbon)
 - D. Chemical processes (e.g., disinfection, ion exchange, softening, coagulation, precipitation)
 - E. Biological processes (e.g., activated sludge, fixed film, lagoons, phytoremediation, aerobic, anaerobic, anoxic)
 - F. Sludge treatment and handling (e.g., land application, digestion, sludge dewatering, composting)
 - G. Water conservation and reuse
- 13. Air Quality and Control** **8–12**
- A. Ambient and indoor air quality (e.g., criteria, toxic and hazardous air pollutants)
 - B. Mass and energy balances (e.g., STP basis, loading rates, heating values)
 - C. Emissions (e.g., factors, rates)
 - D. Atmospheric modeling and meteorology (e.g., stability classes, dispersion modeling, lapse rates)
 - E. Gas treatment technologies (e.g., biofiltration, scrubbers, adsorbers, incineration, catalytic reducers)
 - F. Particle treatment technologies (e.g., baghouses, cyclones, electrostatic precipitators)
 - G. Indoor air quality modeling and controls (e.g., air exchanges, steady- and nonsteady-state reactor model)
- 14. Solid and Hazardous Waste** **7–11**
- A. Mass and energy balances
 - B. Solid waste management (e.g., collection, transportation, storage, composting, recycling, waste to energy)
 - C. Solid waste disposal (e.g., landfills, leachate and gas collection)
 - D. Hazardous waste compatibility
 - E. Site characterization (e.g., sampling, monitoring, remedial investigation)
 - F. Hazardous and radioactive waste treatment and disposal (e.g., physical, chemical, thermal, biological)
- 15. Energy and Environment** **4–6**
- A. Energy sources concepts (e.g., conventional and alternative)
 - B. Environmental impact of energy sources and production (e.g., greenhouse gas production, carbon footprint, thermal, water needs)

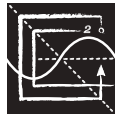

Fundamentals of Engineering (FE) INDUSTRIAL AND SYSTEMS CBT Exam Specifications Effective Beginning with the July 2020 Examinations

- The FE exam is a computer-based test (CBT). It is closed book with an electronic reference.
- Examinees have 6 hours to complete the exam, which contains 110 questions. The 6-hour time also includes a tutorial and an optional scheduled break.
- The FE exam uses both the International System of Units (SI) and the U.S. Customary System (USCS).

Knowledge	Number of Questions
1. Mathematics	6–9
A. Analytic geometry (e.g., areas, volumes)	
B. Calculus (e.g., derivatives, integrals, progressions, series)	
C. Linear algebra (e.g., matrix operations, vector analysis)	
2. Engineering Sciences	4–6
A. Thermodynamics and fluid mechanics	
B. Statics, dynamics, and materials	
C. Electricity and electrical circuits	
3. Ethics and Professional Practice	4–6
A. Codes of ethics and licensure	
B. Agreements and contracts	
C. Professional, ethical, and legal responsibility	
D. Public protection and regulatory issues	
4. Engineering Economics	9–14
A. Discounted cash flows (e.g., nonannual compounding, time value of money)	
B. Evaluation of alternatives (e.g., PW, EAC, FW, IRR, benefit-cost)	
C. Cost analyses (e.g., fixed/variable, breakeven, estimating, overhead, inflation, incremental, sunk, replacement)	
D. Depreciation and taxes (e.g., MACRS, straight line, after-tax cash flow, recapture)	
5. Probability and Statistics	10–15
A. Probabilities (e.g., permutations and combinations, sets, laws of probability)	
B. Probability distributions and functions (e.g., types, statistics, central limit theorem, expected value, linear combinations)	
C. Estimation, confidence intervals, and hypothesis testing (e.g., normal, t, chi-square, types of error, sample size)	
D. Linear regression (e.g., parameter estimation, residual analysis, correlation)	

- 6. Modeling and Quantitative Analysis** **9–14**
- A. Data, logic development, and analytics (e.g., databases, flowcharts, algorithms, data science techniques)
 - B. Linear programming and optimization (e.g., formulation, solution, interpretation)
 - C. Stochastic models and simulation (e.g., queuing, Markov processes, inverse probability functions)
- 7. Engineering Management** **8–12**
- A. Principles and tools (e.g., planning, organizing, motivational theory, organizational structure)
 - B. Project management (e.g., WBS, scheduling, PERT, CPM, earned value, agile)
 - C. Performance measurement (e.g., KPIs, productivity, wage scales, balance scorecard, customer satisfaction)
 - D. Decision making and risk (e.g., uncertainty, utility, decision trees, financial risk)
- 8. Manufacturing, Service, and Other Production Systems** **9–14**
- A. Manufacturing processes (e.g., machining, casting, welding, forming, dimensioning, new technologies)
 - B. Manufacturing and service systems (e.g., throughput, measurement, automation, line balancing, energy management)
 - C. Forecasting (e.g., moving average, exponential smoothing, tracking signals)
 - D. Planning and scheduling (e.g., inventory, aggregate planning, MRP, theory of constraints, sequencing)
 - E. Process improvements (e.g., lean systems, sustainability, value engineering)
- 9. Facilities and Supply Chain** **9–14**
- A. Flow, layout, and location analysis (e.g., from/to charts, layout types, distance metrics)
 - B. Capacity analysis (e.g., number of machines and people, trade-offs, material handling)
 - C. Supply chain management and design (e.g., pooling, transportation, network design, single-level/multilevel distribution models)
- 10. Human Factors, Ergonomics, and Safety** **8–12**
- A. Human factors (e.g., displays, controls, usability, cognitive engineering)
 - B. Safety and industrial hygiene (e.g., workplace hazards, safety programs, regulations, environmental hazards)
 - C. Ergonomics (e.g., biomechanics, cumulative trauma disorders, anthropometry, workplace design, macroergonomics)
- 11. Work Design** **7–11**
- A. Methods analysis (e.g., charting, workstation design, motion economy)
 - B. Work measurement (e.g., time study, predetermined time systems, work sampling, standards)
 - C. Learning curves

- 12. Quality** **9–14**
- A. Quality management, planning, assurance, and systems (e.g., Six Sigma, QFD, TQM, house of quality, fishbone, Taguchi loss function)
 - B. Quality control (e.g., control charts, process capability, sampling plans, OC curves, DOE)
- 13. Systems Engineering, Analysis, and Design** **8–12**
- A. Requirements analysis and system design
 - B. Functional analysis and configuration management
 - C. Risk management (e.g., FMEA, fault trees, uncertainty)
 - D. Life-cycle engineering
 - E. Reliability engineering (e.g., MTTF, MTBR, availability, parallel and series failure)

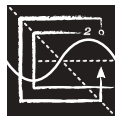

Fundamentals of Engineering (FE) MECHANICAL CBT Exam Specifications

Effective Beginning with the July 2020 Examinations

- The FE exam is a computer-based test (CBT). It is closed book with an electronic reference.
- Examinees have 6 hours to complete the exam, which contains 110 questions. The 6-hour time also includes a tutorial and an optional scheduled break.
- The FE exam uses both the International System of Units (SI) and the U.S. Customary System (USCS).

Knowledge	Number of Questions
1. Mathematics	6–9
A. Analytic geometry	
B. Calculus (e.g., differential, integral, single-variable, multivariable)	
C. Ordinary differential equations (e.g., homogeneous, nonhomogeneous, Laplace transforms)	
D. Linear algebra (e.g., matrix operations, vector analysis)	
E. Numerical methods (e.g., approximations, precision limits, error propagation, Taylor's series, Newton's method)	
F. Algorithm and logic development (e.g., flowcharts, pseudocode)	
2. Probability and Statistics	4–6
A. Probability distributions (e.g., normal, binomial, empirical, discrete, continuous)	
B. Measures of central tendencies and dispersions (e.g., mean, mode, standard deviation, confidence intervals)	
C. Expected value (weighted average) in decision making	
D. Regression (linear, multiple), curve fitting, and goodness of fit (e.g., correlation coefficient, least squares)	
3. Ethics and Professional Practice	4–6
A. Codes of ethics (e.g., NCEES <i>Model Law</i> , professional and technical societies, ethical and legal considerations)	
B. Public health, safety, and welfare	
C. Intellectual property (e.g., copyright, trade secrets, patents, trademarks)	
D. Societal considerations (e.g., economic, sustainability, life-cycle analysis, environmental)	
4. Engineering Economics	4–6
A. Time value of money (e.g., equivalence, present worth, equivalent annual worth, future worth, rate of return, annuities)	
B. Cost types and breakdowns (e.g., fixed, variable, incremental, average, sunk)	
C. Economic analyses (e.g., cost-benefit, breakeven, minimum cost, overhead, life cycle)	

5. Electricity and Magnetism	5–8
<ul style="list-style-type: none"> A. Electrical fundamentals (e.g., charge, current, voltage, resistance, power, energy, magnetic flux) B. DC circuit analysis (e.g., Kirchhoff's laws, Ohm's law, series, parallel) C. AC circuit analysis (e.g., resistors, capacitors, inductors) D. Motors and generators 	
6. Statics	9–14
<ul style="list-style-type: none"> A. Resultants of force systems B. Concurrent force systems C. Equilibrium of rigid bodies D. Frames and trusses E. Centroids and moments of inertia F. Static friction 	
7. Dynamics, Kinematics, and Vibrations	10–15
<ul style="list-style-type: none"> A. Kinematics of particles B. Kinetic friction C. Newton's second law for particles D. Work-energy of particles E. Impulse-momentum of particles F. Kinematics of rigid bodies G. Kinematics of mechanisms H. Newton's second law for rigid bodies I. Work-energy of rigid bodies J. Impulse-momentum of rigid bodies K. Free and forced vibrations 	
8. Mechanics of Materials	9–14
<ul style="list-style-type: none"> A. Shear and moment diagrams B. Stress transformations and Mohr's circle C. Stress and strain caused by axial loads D. Stress and strain caused by bending loads E. Stress and strain caused by torsional loads F. Stress and strain caused by shear G. Stress and strain caused by temperature changes H. Combined loading I. Deformations J. Column buckling K. Statically indeterminate systems 	

9. Material Properties and Processing	7–11
<ul style="list-style-type: none"> A. Properties (e.g., chemical, electrical, mechanical, physical, thermal) B. Stress-strain diagrams C. Ferrous metals D. Nonferrous metals E. Engineered materials (e.g., composites, polymers) F. Manufacturing processes G. Phase diagrams, phase transformation, and heat treating H. Materials selection I. Corrosion mechanisms and control J. Failure mechanisms (e.g., thermal failure, fatigue, fracture, creep) 	
10. Fluid Mechanics	10–15
<ul style="list-style-type: none"> A. Fluid properties B. Fluid statics C. Energy, impulse, and momentum D. Internal flow E. External flow F. Compressible flow (e.g., Mach number, isentropic flow relationships, normal shock) G. Power and efficiency H. Performance curves I. Scaling laws for fans, pumps, and compressors 	
11. Thermodynamics	10–15
<ul style="list-style-type: none"> A. Properties of ideal gases and pure substances B. Energy transfers C. Laws of thermodynamics D. Processes E. Performance of components F. Power cycles G. Refrigeration and heat pump cycles H. Nonreacting mixtures of gases I. Psychrometrics J. Heating, ventilation, and air-conditioning (HVAC) processes K. Combustion and combustion products 	
12. Heat Transfer	7–11
<ul style="list-style-type: none"> A. Conduction B. Convection C. Radiation D. Transient processes E. Heat exchangers 	
13. Measurements, Instrumentation, and Controls	5–8
<ul style="list-style-type: none"> A. Sensors and transducers B. Control systems (e.g., feedback, block diagrams) C. Dynamic system response D. Measurement uncertainty (e.g., error propagation, accuracy, precision, significant figures) 	

14. Mechanical Design and Analysis

10–15

- A. Stress analysis of machine elements
- B. Failure theories and analysis
- C. Deformation and stiffness
- D. Springs
- E. Pressure vessels and piping
- F. Bearings
- G. Power screws
- H. Power transmission
- I. Joining methods (e.g., welding, adhesives, mechanical fasteners)
- J. Manufacturability (e.g., limits, fits)
- K. Quality and reliability
- L. Components (e.g., hydraulic, pneumatic, electromechanical)
- M. Engineering drawing interpretations and geometric dimensioning and tolerancing (GD&T)

**Fundamentals of Engineering (FE)
 OTHER DISCIPLINES CBT Exam Specifications
 Effective Beginning with the July 2020 Examinations**

- The FE exam is a computer-based test (CBT). It is closed book with an electronic reference.
- Examinees have 6 hours to complete the exam, which contains 110 questions. The 6-hour time also includes a tutorial and an optional scheduled break.
- The FE exam uses both the International System of Units (SI) and the U.S. Customary System (USCS).

Knowledge	Number of Questions
1. Mathematics A. Analytic geometry and trigonometry B. Differential equations C. Numerical methods (e.g., algebraic equations, roots of equations, approximations, precision limits, convergence) D. Linear algebra (e.g., matrix operations) E. Single-variable calculus	8–12
2. Probability and Statistics A. Estimation (e.g., point, confidence intervals) B. Expected value and expected error in decision making C. Sample distributions and sizes (e.g., significance, hypothesis testing, non-normal distributions) D. Goodness of fit (e.g., correlation coefficient, standard errors, R^2)	6–9
3. Chemistry A. Oxidation and reduction (e.g., reactions, corrosion control) B. Acids and bases (e.g., pH, buffers) C. Chemical reactions (e.g., stoichiometry, equilibrium, bioconversion)	5–8
4. Instrumentation and Controls A. Sensors (e.g., temperature, pressure, motion, pH, chemical constituents) B. Data acquisition (e.g., logging, sampling rate, sampling range, filtering, amplification, signal interface, signal processing, analog/digital [A/D], digital/analog [D/A], digital) C. Logic diagrams	4–6
5. Engineering Ethics and Societal Impacts A. Codes of ethics (e.g., identifying and solving ethical dilemmas) B. Public protection issues (e.g., licensing boards) C. Societal impacts (e.g., economic, sustainability, life-cycle analysis, environmental, public safety)	5–8

- 6. Safety, Health, and Environment** **6–9**
- A. Industrial hygiene (e.g., carcinogens, toxicology, exposure limits, radiation exposure, biohazards, half-life)
 - B. Basic safety equipment (e.g., pressure-relief valves, emergency shutoffs, fire prevention and control, personal protective equipment)
 - C. Gas detection and monitoring (e.g., O₂, CO, CO₂, CH₄, H₂S, radon)
 - D. Electrical safety
 - E. Confined space entry and ventilation rates
 - F. Hazard communications (e.g., SDS, proper labeling, concentrations, fire ratings, safety equipment)
- 7. Engineering Economics** **6–9**
- A. Time value of money (e.g., present worth, annual worth, future worth, rate of return)
 - B. Cost analysis (e.g., incremental, average, sunk, estimating)
 - C. Economic analyses (e.g., breakeven, benefit-cost, optimal economic life)
 - D. Uncertainty (e.g., expected value and risk)
 - E. Project selection (e.g., comparison of projects with unequal lives, lease/buy/make, depreciation, discounted cash flow, decision trees)
- 8. Statics** **9–14**
- A. Vector analysis
 - B. Force systems (e.g., resultants, concurrent, distributed)
 - C. Force couple systems
 - D. Equilibrium of rigid bodies (e.g., support reactions)
 - E. Internal forces in rigid bodies (e.g., trusses, frames, machines)
 - F. Area properties (e.g., centroids, moments of inertia, radius of gyration, parallel axis theorem)
 - G. Static friction
 - H. Free-body diagrams
 - I. Weight and mass computations (e.g., slug, lb_m, lb_f, kg, N, ton, dyne, g, g_c)
- 9. Dynamics** **9–14**
- A. Particle and rigid-body kinematics
 - B. Linear motion (e.g., force, mass, acceleration)
 - C. Angular motion (e.g., torque, inertia, acceleration)
 - D. Mass moment of inertia
 - E. Impulse and momentum (e.g., linear, angular)
 - F. Work, energy, and power
 - G. Dynamic friction
 - H. Vibrations (e.g., natural frequency)
- 10. Strength of Materials** **9–14**
- A. Stress types (e.g., normal, shear)
 - B. Combined loading—principle of superposition
 - C. Stress and strain caused by axial loads, bending loads, torsion, or transverse shear forces
 - D. Shear and moment diagrams
 - E. Analysis of beams, trusses, frames, and columns
 - F. Loads and deformations (e.g., axial-extension, torque-angle of twist, moment-rotation)

- G. Stress transformation and principal stresses, including stress-based yielding and fracture criteria (e.g., Mohr's circle, maximum normal stress, Tresca, von Mises)
- H. Material failure (e.g., Euler buckling, creep, fatigue, brittle fracture, stress concentration factors, factor of safety, and allowable stress)

11. Materials

6–9

- A. Physical (phase diagrams) properties of materials (e.g., alloy phase diagrams, phase equilibrium, and phase change)
- B. Mechanical properties of materials
- C. Chemical properties of materials
- D. Thermal properties of materials
- E. Electrical properties of materials
- F. Material selection

12. Fluid Mechanics

12–18

- A. Fluid properties (e.g., Newtonian, non-Newtonian, liquids and gases)
- B. Dimensionless numbers (e.g., Reynolds number, Froude number, Mach number)
- C. Laminar and turbulent flow
- D. Fluid statics (e.g., hydrostatic head)
- E. Energy, impulse, and momentum equations (e.g., Bernoulli equation)
- F. Pipe and duct flow and friction losses (e.g., pipes, valves, fittings, laminar, transitional and turbulent flow)
- G. Open-channel flow (e.g., Manning's equation, drag)
- H. Fluid transport systems (e.g., series and parallel operations)
- I. Flow measurement (e.g., pitot tube, venturi meter, weir)
- J. Turbomachinery (e.g., pumps, turbines, fans, compressors)
- K. Ideal gas law (e.g., mixtures of nonreactive gases)
- L. Real gas law (e.g., z factor)

13. Basic Electrical Engineering

6–9

- A. Electrical fundamentals (e.g., charge, current, voltage, resistance, power, energy)
- B. Current and voltage laws (e.g., Kirchhoff, Ohm)
- C. AC and DC circuits (e.g., real and imaginary components, complex numbers, power factor, reactance and impedance, series, parallel, capacitance and inductance, RLC circuits)
- D. Measuring devices (e.g., voltmeter, ammeter, wattmeter)
- E. Three-phase power (e.g., motor efficiency, balanced loads, power equation)

14. Thermodynamics and Heat Transfer

9–14

- A. Thermodynamic laws (e.g., first law, second law)
- B. Thermodynamic equilibrium
- C. Thermodynamic properties (e.g., entropy, enthalpy, heat capacity)
- D. Thermodynamic processes (e.g., isothermal, adiabatic, reversible, irreversible)
- E. Heat transfer (e.g., conduction, convection, radiation)
- F. Mass and energy balances
- G. Property and phase diagrams (e.g., T-s, P-h, P-v)
- H. Combustion and combustion products (e.g., CO, CO₂, NO_x, ash, particulates)
- I. Psychrometrics (e.g., relative humidity, wet bulb)